

REBSTOCK

Precision made in Germany



Cardiovascular

Cardiovasculaire · Cardiovascular
Cardio-vascolare

// WILLKOMMEN BEI REBSTOCK
WELCOME TO REBSTOCK



Qualität Made in Germany. Hochpräzise Instrumente für mehr Sicherheit von Patienten und Operateure.

Quality Made in Germany. Highly precise instruments for more safety of patients and surgeons.

Qualité Made in Germany. Instruments de haute précision pour plus de sécurité pour les patients ainsi que pour les chirurgiens.

Calidad Made in Germany. Instrumentos muy precisos por más seguridad para los pacientes y los operadores.

Qualità Made in Germany. Strumenti precisissimi per una maggiore sicurezza di pazienti e chirurghi.

PRECISION + INNOVATION



// **DIE KUNDEN STEHEN AN OBERSTER STELLE**
THE CUSTOMERS ARE OUR TOP PRIORITY

SERVICE + SUPPORT



Zuverlässiger Lieferservice, garantierter After Sales Service sowie kompetente und fachkundige Beratung. Ihre Zufriedenheit ist unser oberstes Ziel.

Reliable delivery service, guaranteed After Sales Service and competent expert advice. Your satisfaction is our utmost goal.

Service de livraison fiable, service après vente garanti ainsi qu'une consultation compétente et avertie. Votre satisfaction est notre objectif suprême.

Servicio de entrega fiable, servicio post-venta garantizado así como consulta experta y competente. Su satisfacción es nuestro objetivo máximo.

Servizio consegne affidabile, post vendite garantito e consulenza competente. La Vostra soddisfazione è il nostro obiettivo principale.



// **QUALITÄT IN DER PRODUKTION** *PRODUCTION QUALITY*

Beste Rohmaterialien, modernste Technologie und qualifiziertes Fachpersonal sind unsere Gewähr für langlebige Instrumente und Implantate mit höchster Funktionalität.

Best raw materials, modern technology and qualified staff are our guarantee for durable instruments and implants with high functionality.

Le mieux matériau brut, technologies les plus modernes et spécialistes qualifiés sont notre garantie pour des instruments et implants durables avec une fonctionnalité suprême.

Mejor materia prima, tecnología modernísima y personal experto son nuestra garantía para instrumentos e implantes duraderos con un máximo de funcionalidad.

Le migliori materie prime, tecnologia moderna e personale qualificato garantiscono strumenti e impianti durevoli e funzionali.





RESEARCH +
DEVELOPMENT

// **DIE ZUKUNFT WIRD REALITÄT**
THE FUTURE BECOMES REALITY

Ständige Neu- und Weiterentwicklung angepasst an den medizinischen Fortschritt tragen zu einer permanenten Programmerweiterung bei.

Permanent new developments and enhancements due to the medical progress are crucial for a continuously growing product portfolio.

Innovation et progression de façon continue adaptées au progrès médical contribuent à une permanente élargissement de notre programme.

Continuo desarrollo y perfeccionamiento adaptado al progreso médico contribuyen a un aumento permanente del programa.

Continui sviluppi e aggiornamenti al passo con il progresso della medicina contribuiscono ad un permanente allargamento del assortimento dei prodotti.





// **HOCHWERTIGE MEDIZINTECHNIK**
TOP-QUALITY MEDICAL TECHNOLOGY

Präzision bis ins Detail garantiert Langlebigkeit, Sicherheit, Zuverlässigkeit und Funktionalität.

Precision down to the last detail guarantees durability, safety, reliability and functionality.

Précision jusqu'au moindre détail garantit une longue durée de vie, sécurité, fiabilité et fonctionnalité.

Precisión hasta el detalle garantiza duración, seguridad, confiabilidad y funcionamiento.

Precisione fin nel dettaglio garantiscono durevolezza, sicurezza, affidabilità e funzionalità.



COMPETENCE IN PERFECTION

© Copyright by Rebstock Instruments GmbH. Alle Rechte vorbehalten. Nachdruck, auch auszugsweise, verboten. Kein Teil dieses Katalogs darf ohne schriftliche Genehmigung der Firma Rebstock Instruments GmbH in irgendeiner Form reproduziert oder unter Verwendung elektronischer Systeme verarbeitet, vervielfältigt oder verbreitet werden.

© *Copyright by Rebstock Instruments GmbH. All rights reserved. Full or partial reproduction prohibited. No part of this catalogue may be reproduced, processed or transmitted in any form or manner, electronic or mechanical without written permission of Rebstock Instruments GmbH.*

© Copyright by Rebstock Instruments GmbH. Tous droits réservés. La reproduction intégrale ou partielle est interdite. Aucune partie de ce catalogue ne doit pas être reproduite sous quelque forme et ne doit pas être traitée, copiée ou diffusée au moyen de systèmes électroniques sans l'autorisation de Rebstock Instruments GmbH.

© *Copyright by Rebstock Instruments GmbH. Todos los derechos reservados. Queda prohibido la reproducción total o parcial. No parte de este catálogo debe ser procesado o reproducido por cualquier medio, comprendido el tratamiento informática sin la autorización escrita de Rebstock Instruments GmbH.*

© I diritti d'autore sono di Rebstock Instruments GmbH, che si riserva tutti i diritti. La riproduzione, anche solo parziale, è vietata. Nessuna parte di questo catalogo può essere in alcuna forma riprodotta o elaborata e moltiplicata con l'uso di sistemi elettronici senza l'assenso scritto della ditta Rebstock Instruments GmbH.

Ausgabe: Oktober 2011
Distribution: October 2011

Bulldogklemmen, Gefäßclips

*Bulldog Clamps, Vessel Clips · Clamps Bulldog, Clips vasculaires
Clamps Bulldog, Clips vasculares · Pinze Bulldog, Clips vascolari*

// 01



1

Atraumatische Gefäßklemmen

*Atraumatic Vascular Clamps · Pincés vasculaires atraumatiques
Pinzas vasculares atraumáticas · Pinze vascolari atraumatiche*

// 02



2

Atraumatische Pinzetten

*Atraumatic Tissue Forceps · Pincés atraumatiques
Pinzas atraumáticas · Pinze atraumatiche*

// 03



3

Rippensperrer

*Rib Spreaders · Ecarteurs pour costaux
Separadores costales · Divaricatori costali*

// 04



4

Atrium, Aorta-Instrumente

*Atrium-, Aortic Instruments · Instruments pour l'oreillette et l'aorte
Instrumentos para el atrium y la aorta · Strumenti per atrio e aorta*

// 05



5

Wundhaken, Wundspreizer

*Retractors · Ecarteurs
Separadores · Divaricatori*

// 06



6

Sonden, Dilatationsinstrumente

*Probes, Instruments for dilatation · Sondes, Instruments pour la dilatation
Sondas, Instrumentos para la dilatación · Sonda, Strumenti a dilatazione*

// 07



7

Mikro-Instrumente

*Micro Instruments · Micro instruments
Instrumentos para microcirugía · strumenti per microchirurgia*

// 08



8

Allgemeinchirurgische Instrumente

*General surgery instruments · Instruments pour la chirurgie générale
Instrumentos para la cirugía general · Strumenti per chirurgia generale*

// 09



9

Orthopädische Instrumente

*Orthopaedic Instruments · Instruments pour l'orthopédie
Instrumentos para ortopedia · Strumenti per ortopedia*

// 10



10



Bulldogklemmen, Gefäßclips

*Bulldog Clamps, Vessel Clips · Clamps Bulldog, Clips vasculaires
Clamps Bulldog, Clips vasculares · Pinze Bulldog, Clips vascolari*

// 01

1

Atraumatische Gefäßklemmen

*Atraumatic Vascular Clamps · Pincés vasculaires atraumatiques
Pinzas vasculares atraumáticas · Pinze vascolari atraumatiche*

// 02

Atraumatische Pinzetten

*Atraumatic Tissue Forceps · Pincés atraumatiques
Pinzas atraumáticas · Pinze atraumatiche*

// 03

Rippensperrer

*Rib Spreaders · Ecarteurs pour costaux
Separadores costales · Divaricatori costali*

// 04

Atrium, Aorta-Instrumente

*Atrium-, Aortic Instruments · Instruments pour l'oreillette et l'aorte
Instrumentos para el atrium y la aorta · Strumenti per atrio e aorta*

// 05

Wundhaken, Wundspreizer

*Retractors · Ecarteurs
Separadores · Divaricatori*

// 06

Sonden, Dilatationsinstrumente

*Probes, Instruments for dilatation · Sondes, Instruments pour la dilatation
Sondas, Instrumentos para la dilatación · Sonda, Strumenti a dilatazione*

// 07

Mikro-Instrumente

*Micro Instruments · Micro instruments
Instrumentos para microcirugía · strumenti per microchirurgia*

// 08

Allgemeinchirurgische Instrumente

*General surgery instruments · Instruments pour la chirurgie générale
Instrumentos para la cirugía general · Strumenti per chirurgia generale*

// 09

Orthopädische Instrumente

*Orthopaedic Instruments · Instruments pour l'orthopédie
Instrumentos para ortopedia · Strumenti per ortopedia*

// 10

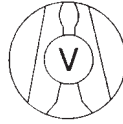

Schließkraft (110), für Venen
 Closing pressure (110), for veins
 Force de fermeture (110), pour veines
 Fuerza de cierre (110), para venas
 Forza di chiusura (110), per vene

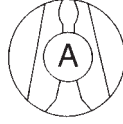

Schließkraft (220), für Arterien
 Closing pressure (220), for arteries
 Force de fermeture (220), pour artères
 Fuerza de cierre (220), para arterias
 Forza di chiusura (220), per arterie

1/1

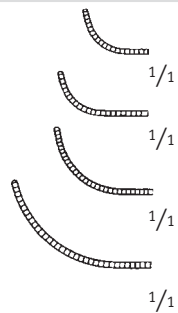
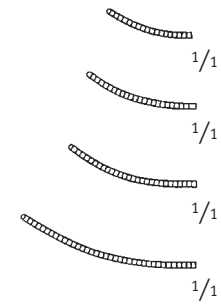
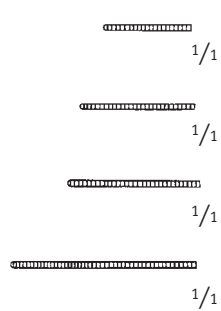
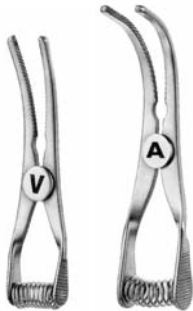
 Artikel-Nr.
 Cat. No.

 Gesamtlänge
 Total length

06-52-300T	Vene, Vein	30 mm / 1 ¹ / ₈ "
06-52-301T	Arterie, Artery	30 mm / 1 ¹ / ₈ "
06-52-302T	Vene, Vein	35 mm / 1 ³ / ₈ "
06-52-303T	Arterie, Artery	35 mm / 1 ³ / ₈ "
06-52-304T	Vene, Vein	40 mm / 1 ¹ / ₂ "
06-52-305T	Arterie, Artery	40 mm / 1 ¹ / ₂ "
06-52-306T	Vene, Vein	50 mm / 2"
06-52-307T	Arterie, Artery	50 mm / 2"

06-52-310T	Vene, Vein	30 mm / 1 ¹ / ₈ "
06-52-311T	Arterie, Artery	30 mm / 1 ¹ / ₈ "
06-52-312T	Vene, Vein	35 mm / 1 ³ / ₈ "
06-52-313T	Arterie, Artery	35 mm / 1 ³ / ₈ "
06-52-314T	Vene, Vein	40 mm / 1 ¹ / ₂ "
06-52-315T	Arterie, Artery	40 mm / 1 ¹ / ₂ "
06-52-316T	Vene, Vein	50 mm / 2"
06-52-317T	Arterie, Artery	50 mm / 2"

06-52-320T	Vene, Vein	30 mm / 1 ¹ / ₈ "
06-52-321T	Arterie, Artery	30 mm / 1 ¹ / ₈ "
06-52-322T	Vene, Vein	35 mm / 1 ³ / ₈ "
06-52-323T	Arterie, Artery	35 mm / 1 ³ / ₈ "
06-52-324T	Vene, Vein	40 mm / 1 ¹ / ₂ "
06-52-325T	Arterie, Artery	40 mm / 1 ¹ / ₂ "
06-52-326T	Vene, Vein	50 mm / 2"
06-52-327T	Arterie, Artery	50 mm / 2"

ATRAUMA



DE BAKEY

Artikel-Nr. Cat. No.	Gesamtlänge Total length		
02-52-200	50 mm / 2"	DE BAKEY-DIETRICH	1/1
02-52-201	55 mm / 2 ¹ / ₈ "	DE BAKEY-DIETRICH	1/1
02-52-202	60 mm / 2 ¹ / ₄ "	DE BAKEY-DIETRICH	1/1



1/1

02-52-203	50 mm / 2"	DE BAKEY-DIETRICH	1/1
02-52-204	55 mm / 2 ¹ / ₈ "	DE BAKEY-DIETRICH	1/1
02-52-205	60 mm / 2 ¹ / ₄ "	DE BAKEY-DIETRICH	1/1

02-52-210	50 mm / 2"	DIETRICH	1/1
02-52-211	55 mm / 2 ¹ / ₈ "	DIETRICH	1/1
02-52-212	60 mm / 2 ¹ / ₄ "	DIETRICH	1/1

02-52-213	50 mm / 2"	DIETRICH	1/1
02-52-214	55 mm / 2 ¹ / ₈ "	DIETRICH	1/1
02-52-215	60 mm / 2 ¹ / ₄ "	DIETRICH	1/1



1/1

ATRAUMA

DE BAKEY

 $\frac{2}{3}$

DE BAKEY

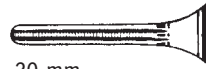

20 mm

 Artikel-Nr.
 Cat. No.

06-02-420

 Gesamtlänge
 Total length

80 mm / 3"

DE BAKEY



30 mm

06-02-422

90 mm / 3 1/2"

DE BAKEY



45 mm

06-02-424

105 mm / 4 1/4"

DE BAKEY



68 mm

06-02-426

125 mm / 4 3/4"

ATRAUMA

DE BAKEY

 $\frac{2}{3}$

DE BAKEY

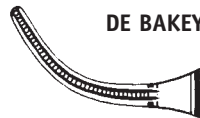

20 mm

06-02-421

75 mm / 2 3/4"

DE BAKEY

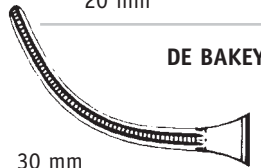

30 mm

06-02-423

85 mm / 3 1/4"

DE BAKEY

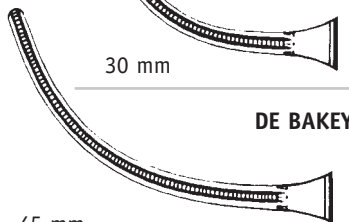

45 mm

06-02-425

95 mm / 3 1/2"

DE BAKEY

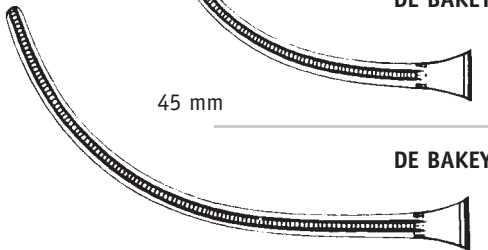

68 mm

06-02-427

115 mm / 4 1/2"

Artikel-Nr. Cat. No.	Gesamtlänge Total length
06-52-358	90 mm / 3 1/2"
06-52-359	110 mm / 4 1/4"
06-52-360	90 mm / 3 1/2"
06-52-361	110 mm / 4 1/4"

GREGORY-
"SOFT"



GREGORY-
"SOFT"



GREGORY-
"SOFT"



GREGORY-
"SOFT"

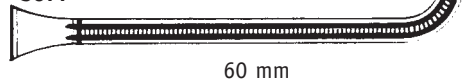

ATRAUMA



DE BAKEY



1/2

06-52-363	110 mm / 4 1/4" links left · gauche · izquierda · sinistra
06-52-362	110 mm / 4 1/4" rechts right · droite · derecha · destra

GREGORY-
"SOFT"



GREGORY-
"SOFT"



ATRAUMA



DE BAKEY



1/2

06-52-364	70 mm / 2 3/4"
-----------	----------------



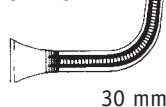

SANTULLI







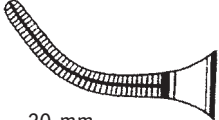
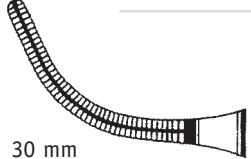
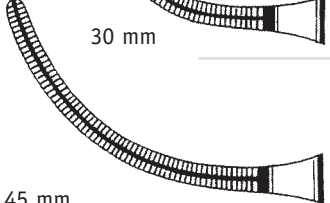
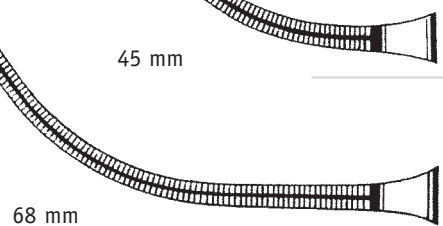

ATRAUMA





COOLEY

1/1

	Artikel-Nr. Cat. No.	Gesamtlänge Total length
 20 mm	COOLEY 06-52-366	80 mm / 3"
 30 mm	COOLEY 06-52-368	90 mm / 3 1/2"
 45 mm	COOLEY 06-52-370	105 mm / 4 1/4"
 68 mm	COOLEY 06-52-372	125 mm / 4 3/4"
 20 mm	COOLEY 06-52-367	75 mm / 2 3/4"
 30 mm	COOLEY 06-52-369	85 mm / 3 1/4"
 45 mm	COOLEY 06-52-371	95 mm / 3 3/4"
 68 mm	COOLEY 06-52-373	115 mm / 4 1/2"

Artikel-Nr. Cat. No.	Gesamtlänge Total length	GLOVER	20 mm	30 mm	43 mm	56 mm	ATRAUMA  DE BAKEY
06-52-430	70 mm / 2 1/2"						 1/2
06-02-432	80 mm / 3"						
06-02-434	95 mm / 3 1/2"						
06-02-436	115 mm / 4 1/2"						

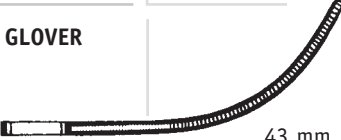
mit Rändelschraube zur individuellen Druckeinstellung
 with knurled screw for individual pressure adjustment · avec vis moletée pour l'ajustement individuel de la pression · con tornillo moleteado para el
 reglaje individual de la presión · con vite a testa cilindrica zigrinata con coiletto alto per l'aggiustamento individuale della pressione

06-52-431	65 mm / 2 1/2"		20 mm				ATRAUMA  DE BAKEY
06-02-433	75 mm / 2 3/4"		30 mm				
06-02-435	85 mm / 3 1/2"		43 mm				
06-02-437	105 mm / 4 1/2"		56 mm				

mit Rändelschraube zur individuellen Druckeinstellung
 with knurled screw for individual pressure adjustment · avec vis moletée pour l'ajustement individuel de la pression · con tornillo moleteado para el
 reglaje individual de la presión · con vite a testa cilindrica zigrinata con coiletto alto per l'aggiustamento individuale della pressione

ATRAUMA



DE BAKEY



2/3

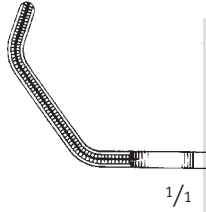

1/1

DE BAKEY

Artikel-Nr.
Cat. No.

06-02-357

Gesamtlänge
Total length

70 mm / 2³/₄"

DE BAKEY

06-02-359

95 mm / 3¹/₂"

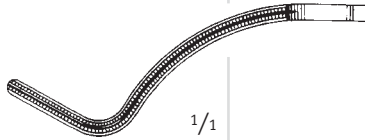

1/1

DE BAKEY

06-02-358

100 mm / 4"



1/1

ATRAUMA



DE BAKEY



2/3

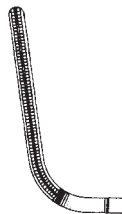





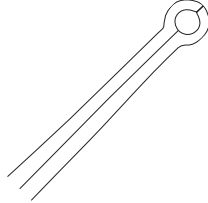

27 mm 1/1

GLOVER







06-02-431



55 mm / 2¹/₄"

Artikel-Nr. Cat. No.	Gesamtlänge Total length	SHUNT		
06-52-380	75 mm / 3" ø 10 Fr.	SHUNT		
06-52-381	ø 12 Fr.			
06-52-382	ø 14 Fr.			
06-52-383	75 mm / 3" ø 10 Fr.	SHUNT		
06-52-384	ø 12 Fr.			
06-52-385	ø 14 Fr.			
06-52-386	75 mm / 3" ø 10 Fr.	SHUNT		
06-52-387	ø 12 Fr.			
06-52-388	ø 14 Fr.			
06-52-389	75 mm / 3" ø 10 Fr.	SHUNT		
06-52-390	ø 12 Fr.			
06-52-391	ø 14 Fr.			

		Artikel-Nr. Cat. No.	Gesamtlänge Total length
 1/1		JOHN-HOPKINS	
		02-58-012	50 mm / 2"
		02-58-013	55 mm / 2 ¹ / ₄ "
		02-58-014	65 mm / 2 ¹ / ₂ "
		02-58-015	70 mm / 2 ³ / ₄ "
		02-58-016	75 mm / 3"
		02-58-017	90 mm / 3 ¹ / ₂ "
 1/1		JOHN-HOPKINS	
		02-08-012	50 mm / 2"
		02-08-013	55 mm / 2 ¹ / ₄ "
		02-08-014	65 mm / 2 ¹ / ₂ "
		02-08-015	70 mm / 2 ³ / ₄ "
		02-08-016	75 mm / 3"
		02-08-017	90 mm / 3 ¹ / ₂ "

 1/3		02-08-018	230 mm / 8 ¹ / ₄ "
			Anlege- und Entfernungszange für Bulldogklemmen <i>Applying and removing forceps for Bulldog Clamps</i> <i>Pince pour poser et retirer les clamps Bulldog</i> <i>Pinza para poner y quitar clamps Bulldog</i> <i>Pinza per applicare e rimuovere clamps Bulldog</i>

Artikel-Nr. Cat. No.	Gesamtlänge Total length				
02-08-020	35 mm / 1 1/2"	DIEFFEN- BACH			
02-08-022	50 mm / 2"				
02-08-021	35 mm / 1 1/2"	DIEFFEN- BACH			
02-08-023	50 mm / 2"				
02-08-026	58 mm / 2 1/4"	DIEFFEN- BACH			
02-08-027	58 mm / 2 1/4"				



		Artikel-Nr. Cat. No.	Gesamtlänge Total length
 1/1	 1/1	06-02-328	45 mm / 1 ³ / ₄ "
	 1/1	06-02-329	45 mm / 1 ³ / ₄ "
	 1/1	06-02-330	50 mm / 2"
	 1/1	06-02-331	50 mm / 2"

mit Rändelschraube zur individuellen Druckeinstellung

with knurled screw for individual pressure adjustment · avec vis moletée pour l'ajustement individuel de la pression · con tornillo moleteado para el reglaje individual de la presión · con vite a testa cilindrica zigrinata con coletto alto per l'aggiustamento individuale della pressione

ATRAUMA

DE BAKEY

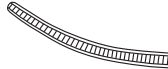
 1/1	 1/1	DE BAKEY	06-02-352	50 mm / 2"
	 1/1	DE BAKEY	06-02-353	50 mm / 2"

mit Rändelschraube zur individuellen Druckeinstellung

with knurled screw for individual pressure adjustment · avec vis moletée pour l'ajustement individuel de la pression · con tornillo moleteado para el reglaje individual de la presión · con vite a testa cilindrica zigrinata con coletto alto per l'aggiustamento individuale della pressione

STANDARD permanent · STANDARD permanent
STANDARD permanent · STANDARD permanente · STANDARD permanente

TITAN/TITANIUM	65 740 T	65 750 T	65 760 T	65 780 T	65 792 T	65 790 T	65 840 T
PHYNOX/PHYNOX	65 740	65 750	65 760	65 780	65 792	65 790	65 840
Öffnung/Opening	6,2 mm	7 mm	7,8 mm	9,2 mm	10,6 mm	11,4 mm	13,3 mm
Druck/Force	150 gms	180 gms	180 gms	200 gms	200 gms	200 gms	200 gms

65 742 T	65 752 T	65 762 T	65 782 T	65 786 T	65 895 T	65 744 T	65 754 T
65 742	65 752	65 762	65 782	65 786	65 895	65 744	65 754
6 mm	6,8 mm	7,5 mm	8,7 mm	10 mm	11 mm	5,5 mm	6,1 mm
150 gms	180 gms	180 gms	200 gms	180 gms	200 gms	150 gms	180 gms

65 764 T	65 784 T	65 896 T	65 823 T	65 824 T	65 825 T	65 748 T	65 758 T
65 764	65 784	65 896	65 823	65 824	65 825	65 748	65 758
6,5 mm	7,4 mm	9,9 mm	5,4 mm	5,8 mm	6,2 mm	7,9 mm	8,7 mm
180 gms	200 gms	200 gms	180 gms	180 gms	180 gms	200 gms	200 gms

STANDARD temporär · STANDARD temporary
STANDARD temporaire · STANDARD temporal · STANDARD temporaneo

TITAN/TITANIUM	65 240 T	65 250 T	65 260 T	65 280 T	65 292 T	65 290 T	65 340 T
PHYNOX/PHYNOX	65 240	65 250	65 260	65 280	65 292	65 290	65 340
Öffnung/Opening	6,2 mm	7 mm	7,8 mm	9,2 mm	10,6 mm	11,4 mm	13,3 mm
Druck/Force	110 gms	90 gms	90 gms	90 gms	90 gms	110 gms	110 gms

65 242 T	65 252 T	65 262 T	65 282 T	65 286 T	65 395 T	65 244 T	65 254 T
65 242	65 252	65 262	65 282	65 286	65 395	65 244	65 254
6 mm	6,8 mm	7,5 mm	8,7 mm	10 mm	11,0 mm	5,5 mm	6,1 mm
110 gms	90 gms	90 gms	110 gms	110 gms	90 gms	110 gms	110 gms

65 264 T	65 284 T	65 396 T	65 323 T	65 324 T	65 325 T	65 248 T	65 258 T
65 264	65 284	65 396	65 323	65 324	65 325	65 248	65 258
6,5 mm	7,4 mm	9,9 mm	5,4 mm	5,8 mm	6,2 mm	7,9 mm	8,7 mm
110 gms	110 gms	90 gms	110 gms	110 gms	110 gms	90 gms	90 gms

MINI permanent · MINI permanent
MINI permanent · MINI permanente · MINI permanente

TITAN/TITANIUM	65 680 T	65 690 T	65 700 T	65 710 T	65 720 T	65 682 T	65 692 T
PHYNOX/PHYNOX	65 680	65 690	65 700	65 710	65 720	65 682	65 692
Öffnung/Opening	3,3 mm	4 mm	3,3 mm	4 mm	4,6 mm	3,2 mm	3,8 mm
Druck/Force	110 gms	110 gms	110 gms	110 gms	110 gms	110 gms	110 gms

TITAN/TITANIUM	65 711 T	65 712 T	65 713 T	65 726 T	65 722 T	65 694 T	65 714 T
PHYNOX/PHYNOX	65 711	65 712	65 713	65 726	65 722	65 694	65 714
Öffnung/Opening	3,6mm	3,8 mm	3,6 mm	4 mm	4,4 mm	3,6 mm	3,5 mm
Druck/Force	110 gms	110 gms	110 gms	110 gms	110 gms	110 gms	110 gms

TITAN/TITANIUM	65 724 T	65 716 T	65 717 T	65 727 T	65 728 T	65 806 T	65 807 T
PHYNOX/PHYNOX	65 724	65 716	65 717	65 727	65 728	65 806	65 807
Öffnung/Opening	4 mm	3,5 mm	6 mm	7 mm	5,7 mm	4,5 mm	4 mm
Druck/Force	110 gms	130 gms	130 gms	130 gms	130 gms	130 gms	130 gms

MINI temporär · MINI temporary
MINI temporaire · MINI temporal · MINI temporaneo

TITAN/TITANIUM	65 180 T	65 190 T	65 200 T	65 210 T	65 220 T	65 182 T	65 192 T
PHYNOX/PHYNOX	65 180	65 190	65 200	65 210	65 220	65 182	65 192
Öffnung/Opening	3,3 mm	4 mm	3,3 mm	4 mm	4,6 mm	3,2 mm	3,8 mm
Druck/Force	90 gms	70 gms	90 gms	70 gms	70 gms	90 gms	70 gms

TITAN/TITANIUM	65 211 T	65 212 T	65 213 T	65 226 T	65 222 T	65 194 T	65 214 T
PHYNOX/PHYNOX	65 211	65 212	65 213	65 226	65 222	65 194	65 214
Öffnung/Opening	3,6 mm	3,8 mm	3,6 mm	4 mm	4,4 mm	3,6 mm	3,5 mm
Druck/Force	80 gms	70 gms	80 gms	70 gms	70 gms	80 gms	80 gms

TITAN/TITANIUM	65 224 T	65 216 T	65 217 T	65 227 T	65 228 T	65 306 T	65 307 T
PHYNOX/PHYNOX	65 224	65 216	65 217	65 227	65 228	65 306	65 307
Öffnung/Opening	4 mm	3,5 mm	6 mm	7 mm	5,7 mm	4,5 mm	4 mm
Druck/Force	70 gms	70 gms	70 gms	70 gms	70 gms	70 gms	70 gms

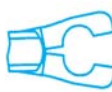
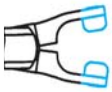
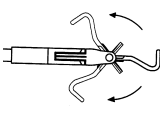
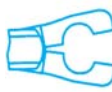
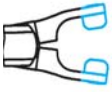
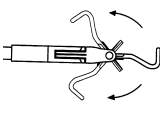
Artikel-Nr. Cat. No.	Gesamtlänge Total length		
06-55-526	190 mm / 7"	STANDARD	
06-55-528	210 mm / 8 ¹ / ₄ "		
06-55-529	230 mm / 9"		
Maul TITAN, starr, doppeltübersetzt Mouth TITANIUM, fixed, double action Mors en TITANE, rigide, double articulation Boca en TITANIO, rigida, doble acción Morso in TITANIO, rigido, doppia articolazione			
06-55-528T	210 mm / 8 ¹ / ₄ "	STANDARD	
06-55-529T	230 mm / 9"		
Maul TITAN, drehbar, doppeltübersetzt Mouth TITANIUM, rotating, double action Mors en TITANE, pivotant, double articulation Boca en TITANIO, rotabile, doble acción Morso in TITANIO, girabile, doppia articolazione			
06-55-520	190 mm / 7"	MINI	
06-55-522	210 mm / 8 ¹ / ₄ "		
06-55-524	230 mm / 9"		
Maul TITAN, starr, doppeltübersetzt Mouth TITANIUM, fixed, double action Mors en TITANE, rigide, double articulation Boca en TITANIO, rigida, doble acción Morso in TITANIO, rigido, doppia articolazione			
06-55-522T	210 mm / 8 ¹ / ₄ "	MINI	
06-55-524T	230 mm / 9"		
Maul TITAN, drehbar, doppeltübersetzt Mouth TITANIUM, rotating, double action Mors en TITANE, pivotant, double articulation Boca en TITANIO, rotabile, doble acción Morso in TITANIO, girabile, doppia articolazione			



 Artikel-Nr.
 Cat. No.

 Gesamtlänge
 Total length

06-20-002

Clip Lagertray mit Deckel aus Kunststoff-PPSU, dampfsterilisierbar bis 3 bar (143°C/289°F) mit 60 Unterteilungen zur Aufnahme von Aneurysmen-Clips

Utility Tray for clips with lid made of plastic PPSU, sterilizable up to 3 bar (143°C/289°F) with space for 60 Aneurysm Clips

Contenant pour clips avec couvercle de plastique PPSU, stérilisable jusqu'à 3 bar (143°C/289°F) avec 60 compartiments pour le stockage des clips anévrismaux

Contenedor para clips con tapa de plástico PPSU, esterilizable hasta 3 bar (143°C/289°F), con 60 compartimentos para el almacenamiento de clips de aneurisma

Contenitore con coperchio in plastica PPSU, sterilizzabile fino a 3 bar (143°C/289°F), con 60 posti per un magazzino dei clips per aneurisma

06-20-007

Lagerungstray mit Deckel aus PPSU-Kunststoff, dampfsterilisierbar bis 3 bar (143°C/289°F) zur Aufnahme von Clip-Anlegezangen

Utility Tray with lid made of plastic PPSU, sterilizable up to 3 bar (143°C/289°F) for Clip applicators

Contenant pour le stockage des pinces à appliquer, avec couvercle de plastique PPSU, stérilisable jusqu'à 3 bar (143°C/289°F)

Contenedor para el almacenamiento de pinzas para aplicar, con tapa de plástico PPSU, esterilizable hasta 3 bar (143°C/289°F)

Contenitore per il magazzino delle pinze per applicare, con coperchio in plastica PPSU, sterilizzabile fino a 3 bar (143°C/289°F)

Artikel-Nr.
Cat. No.

Gesamtlänge
Total length

06-55-010

Lagerungstray aus Edelstahl,
mit 18 Unterteilungen zur Aufnahme von
Aneurysmen Clips

*Utility Tray made of stainless steel,
with space for 18 Aneurysm Clips*

*Contenant en acier inoxydable, avec 18 comparti-
ments pour le stockage des clips anévrismaux*

*Contenedor en acero inoxidable, con 18 compartimentos
para el almacenamiento de los clips de aneurisma*

*Contenitore in inox, con 18 posti per un magazzi-
naggio dei clips per aneurisma*





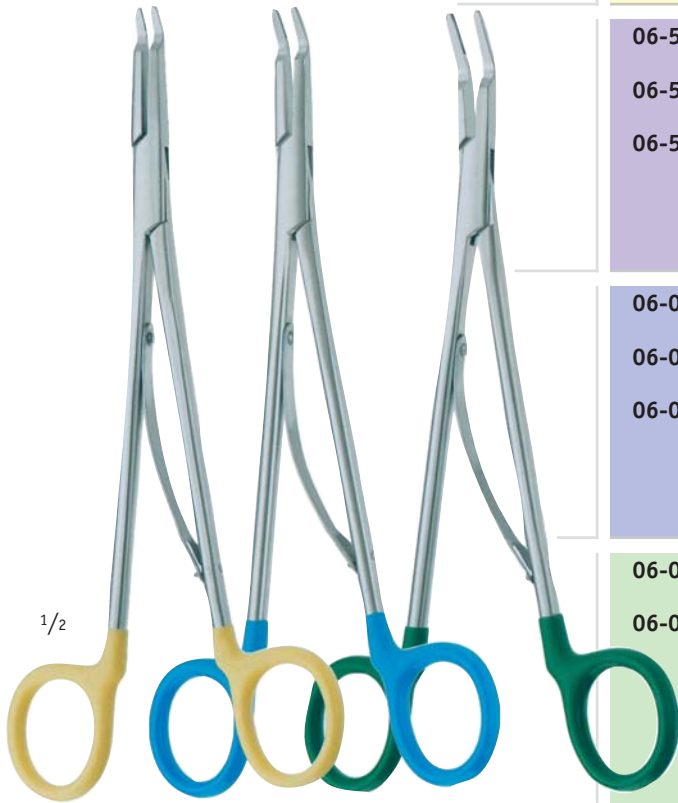































Artikel-Nr. Cat. No.	Artikel-Nr. Cat. No.	Gesamtlänge Total length
SLS STANDARD	ETHICON	
06-52-210		150 mm / 6"
06-52-211		190 mm / 7 ¹ / ₂ "
06-52-212		280 mm / 11"
		mikro, weiß · micro, white · micro, blanc · micro, blanco · micro, bianco
06-02-222	06-52-222	150 mm / 6"
06-02-223	06-52-223	190 mm / 7 ¹ / ₂ "
06-02-224		280 mm / 11"
		klein, gelb · small, yellow · petit, jaune pequeño, amarillo · piccolo, giallo
06-52-213		150 mm / 6"
06-52-214		190 mm / 7 ¹ / ₂ "
06-52-215		280 mm / 11"
		klein-mittel, lila · small-medium, purple · petit-moyen, violet pequeño-mediano, morado · piccolo-medio, ametista
06-02-234	06-52-234	150 mm / 6"
06-02-235	06-52-235	190 mm / 7 ¹ / ₂ "
06-02-236	06-52-236	280 mm / 11"
		mittel, blau · medium, blue · moyen, bleu mediano, azul · medio, blu
06-02-240	06-52-240	190 mm / 7 ¹ / ₂ "
06-02-242	06-52-242	280 mm / 11"
		mittel-groß, grün · medium-large, green · moyen-large, vert mediano-grande, verde · medio-grande, verde
06-02-246	06-52-246	190 mm / 7 ¹ / ₂ "
06-02-248	06-52-248	280 mm / 11"
		groß, orange · large, orange · large, orange · grande, naranja · grande, arancio



Artikel-Nr. Packungsgröße · Packing unit
 Cat. No. Unité d'emballage · Contenido de caja
 Unità confezione

06-52-225	<p>36 à 6 Clips</p> <p>Titan-Clips, klein, gelb Titanium clips, small, yellow Clips en titane, petit, jaune Clips de titanio, pequeño, amarillo Clip di titanio, piccolo, giallo</p>	ETHICON	
			
06-52-237	<p>36 à 6 Clips</p> <p>Titan-Clips, mittel, blau Titanium clips, medium, blue Clips en titane, moyen, bleu Clips de titanio, mediano, azul Clip di titanio, medio, blu</p>	ETHICON	
06-52-243	<p>18 à 6 Clips</p> <p>Titan-Clips, mittel-groß, grün Titanium clips, medium-large, green Clips en titane, moyen-large, vert Clips de titanio, mediano-grande, verde Clip di titanio, medio-grande, verde</p>	ETHICON	
06-52-249	<p>18 à 6 Clips</p> <p>Titan-Clips, groß, orange Titanium clips, large, orange Clips en titane, large, orange Clips de titanio, grande, naranja Clip di titanio, grande, arancio</p>	ETHICON	

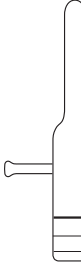
	Einzelklemme <i>Single Clamp</i>	Einzelklemme <i>Single Clamp</i>	Doppelklemme <i>Double Clamp</i>	Approximator <i>Approximator</i>	Approximator <i>Approximator</i>	
8 mm 0,4 - 1 mm ø Gefäß · <i>Vessel · Vaisseau · Vaso · Vaso</i> 						ACLAND Vene · <i>Vein · Veine · Vena · Vena</i> Arterie · <i>Artery · Artère · Arteria · Arteria</i>
11 mm 0,6 - 1,5 mm ø Gefäß · <i>Vessel · Vaisseau · Vaso · Vaso</i> 						ACLAND Vene · <i>Vein · Veine · Vena · Vena</i> Arterie · <i>Artery · Artère · Arteria · Arteria</i>
14 mm 1 - 2 mm ø Gefäß · <i>Vessel · Vaisseau · Vaso · Vaso</i> 						ACLAND Vene · <i>Vein · Veine · Vena · Vena</i> Arterie · <i>Artery · Artère · Arteria · Arteria</i>
17 mm 1 - 2,25 mm ø Gefäß · <i>Vessel · Vaisseau · Vaso · Vaso</i> 						ACLAND Vene · <i>Vein · Veine · Vena · Vena</i> Arterie · <i>Artery · Artère · Arteria · Arteria</i>
25 mm 1,5 - 3,5 mm ø Gefäß · <i>Vessel · Vaisseau · Vaso · Vaso</i> 						ACLAND Vene · <i>Vein · Veine · Vena · Vena</i> Arterie · <i>Artery · Artère · Arteria · Arteria</i>
36 mm 2 - 5 mm ø Gefäß · <i>Vessel · Vaisseau · Vaso · Vaso</i> 						ACLAND Vene · <i>Vein · Veine · Vena · Vena</i> Arterie · <i>Artery · Artère · Arteria · Arteria</i>

Standard Line

Oberfläche matt gebürstet · *Surface polished · Surface brossée*
mate · Superficie cepillada mate · Superficie spazzolata
 Bestellbeispiel · *How to order · Exemple pour commander*
Ejemplo para pedir · Esempio per comandare: 90-80-412



Black Line

Oberfläche schwarz, titanbeschichtet · *Surface black, titanium-coated · Surface noir, enduite*
de titane · Superficie negra, recubierto de titanio · Superficie nera, ricoperta di titanio
 Bestellbeispiel · *How to order · Exemple pour commander*
Ejemplo para pedir · Esempio per comandare: 90-80-412 B



Artikel-Nr. Cat. No.	Gesamtlänge Total length		
90-80-071	140 mm / 5 ¹ / ₂ " mit Schloß with lock avec fermeture con cerradura con serratura	ACLAND	
90-80-072	140 mm / 5 ¹ / ₂ " ohne Schloß without lock sans fermeture sin cerradura senza serratura	ACLAND	

2/3







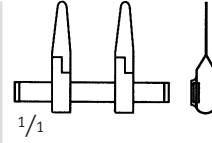

90-80-073	140 mm / 5 ¹ / ₂ " Anlegepinzette, für Einzelklemmen oder zum gleichzeitigen Öffnen beider Klemmen bei Approximatoren und Doppelklemmen Applying Forceps, for opening single clamps and approximators and double clamps simultaneously or individually Pince à appliquer, pour clips simples ou pour l'ouverture simultanée des deux clips des approximateurs et des clips doubles Pinza para aplicar, para clips singulares o para la apertura simultánea de ambos clips de los aproximadores y los clips dobles Pinza per applicare, per clips singoli o per la apertura simultanea di approssimatori e dei clips		
------------------	--	--	---

2/3

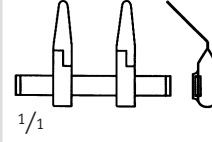
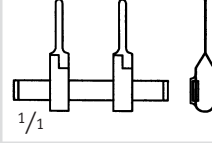
90-80-075	50 x 25 x 4,5 mm
90-80-076	70 x 45 x 8 mm
90-80-077	75 x 25 x 4,5 mm Lagerungstray für Gefäßklemmen Utility Tray for storage of Vessel Clamps Contenant pour le stockage des clips vasculaires Contenedor para el almacenamiento de los clips vasculares Contentitore per il magazzino dei clips vascolari

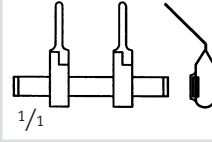
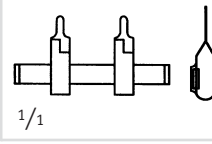
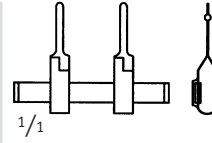
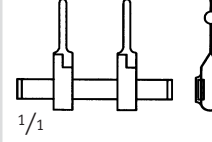

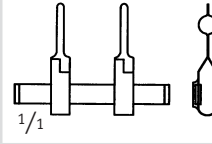
			Artikel-Nr. Cat. No.	Schließkraft Closing Force
1/1			BIEMER 06-04-560	30-40 g Maullänge: 6 mm · length of jaws: 6 mm · Longueur des mors: 6 mm · Longitud de la boca: 6 mm · Lunghezza del morso: 6 mm
			BIEMER 06-04-561	30-40 g Maullänge: 9 mm · length of jaws: 9 mm · Longueur des mors: 9 mm · Longitud de la boca: 9 mm · Lunghezza del morso: 9 mm
			BIEMER 06-04-562	20-25 g Maullänge: 9 mm · length of jaws: 9 mm · Longueur des mors: 9 mm · Longitud de la boca: 9 mm · Lunghezza del morso: 9 mm
1/1			MEHDORN 06-04-552	10-15 g Maul: 4 x 1 mm · Jaws: 4 x 1 mm · Mors: 4 x 1 mm Boca: 4 x 1 mm · Morso: 4 x 1 mm
			MEHDORN 06-04-554	15-20 g Maul: 4 x 1,4 mm · Jaws: 4 x 1,4 mm · Mors: 4 x 1,4 mm Boca: 4 x 1,4 mm · Morso: 4 x 1,4 mm
			MEHDORN 06-04-556	10-15 g Maul: 6 x 1 mm · Jaws: 6 x 1 mm · Mors: 6 x 1 mm Boca: 6 x 1 mm · Morso: 6 x 1 mm
			MEHDORN 06-04-558	15-20 g Maul: 6 x 1,4 mm · Jaws: 6 x 1,4 mm · Mors: 6 x 1,4 mm Boca: 6 x 1,4 mm · Morso: 6 x 1,4 mm
1/1			BIEMER 06-04-570	Approximator Approximator · Approximateur Aproximador · Approssimatore
			06-04-575	Approximator mit Schlüssel 06-04-576 Approximator with key 06-04-576 · Approximateur avec clé 06-04-576 · Aproximador con llave 06-04-576 · Approssimatore con chiave 06-04-576
			06-04-574	Approximator allein Approximator only · Approximateur seul Aproximador solo · Approssimatore solo
			BIEMER 06-04-635	Nerv-Approximator mit Schlüssel 06-04-576 Approximator for nerves with key 06-04-576 Approximateur pour nerfs con clé 06-04-576 Aproximador para nervios con llave 06-04-576 Approssimatore per nervi con chiave 06-04-576
			06-04-634	Nerv-Approximator allein · Approximator for nerves only · Approximateur pour nerfs, seul · Aproximador para nervios, solo · Approssimatore per nervi, solo
1/1		06-04-636	1 Paar Ersatznadeln · 1 pair of spare needles 1 paire d'aiguilles de rechange · 1 par de agujas de repuesto · 1 paio di aghi di ricambio	
		06-04-576	Schlüssel für Approximatoren 06-04-574 und 06-04-634 Key for Approximators 06-04-574 and 06-04-634 Clé pour les approximateurs 06-04-574 et 06-04-634 Llave para los aproximadores 06-04-574 y 06-04-634 Chiave per approssimatori 06-04-574 e 06-04-634	

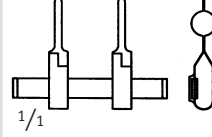
Artikel-Nr. Cat. No.	Schließkraft Closing Force			
06-04-611	25-30 g Maullänge: 9 mm · Length of jaws: 9 mm · Longueur des mors: 9 mm · Longitud de la boca: 9 mm Lunghezza del morso: 9 mm	BIEMER- MÜLLER		
06-04-612	25-30 g Maullänge: 9 mm · Length of jaws: 9 mm · Longueur des mors: 9 mm · Longitud de la boca: 9 mm Lunghezza del morso: 9 mm	BIEMER- MÜLLER		
06-04-613	25-30 g Maullänge: 9 mm · Length of jaws: 9 mm · Longueur des mors: 9 mm · Longitud de la boca: 9 mm Lunghezza del morso: 9 mm	BIEMER- MÜLLER		
06-04-614	25-30 g Maullänge: 9 mm · Length of jaws: 9 mm · Longueur des mors: 9 mm · Longitud de la boca: 9 mm Lunghezza del morso: 9 mm	BIEMER- MÜLLER		
06-04-615	25-30 g Maullänge: 4,5 mm · Length of jaws: 4,5 mm · Longueur des mors: 4,5 mm · Longitud de la boca: 4,5 mm Lunghezza del morso: 4,5 mm	BIEMER- MÜLLER		
06-04-671	25-30 g Maullänge: 9 mm, ø 1 mm · Length of jaws: 9 mm, ø 1 mm Longueur des mors: 9 mm, ø 1 mm · Longitud de la boca: 9 mm, ø 1 mm · Lunghezza del morso: 9 mm, ø 1 mm	MÜLLER		
06-04-672	25-30 g Maullänge: 9 mm, ø 2 mm · Length of jaws: 9 mm, ø 2 mm Longueur des mors: 9 mm, ø 2 mm · Longitud de la boca: 9 mm, ø 2 mm · Lunghezza del morso: 9 mm, ø 2 mm	MÜLLER		
06-04-673	25-30 g Maullänge: 9 mm, ø 3 mm · Length of jaws: 9 mm, ø 3 mm Longueur des mors: 9 mm, ø 3 mm · Longitud de la boca: 9 mm, ø 3 mm · Lunghezza del morso: 9 mm, ø 3 mm	MÜLLER		
06-04-674	25-30 g Maullänge: 9 mm, ø 4 mm · Length of jaws: 9 mm, ø 4 mm Longueur des mors: 9 mm, ø 4 mm · Longitud de la boca: 9 mm, ø 4 mm · Lunghezza del morso: 9 mm, ø 4 mm	MÜLLER		

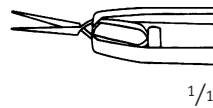

1/1

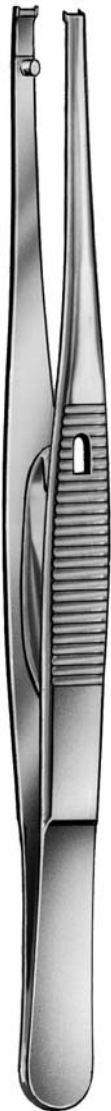

1/1

BIEMER
 Artikel-Nr.
 Cat. No.

 Gesamtlänge
 Total length
06-04-568145 mm / 5³/₄"
 ohne Schloß
 without lock · sans fermeture
 sin cerradura · senza serratura
06-04-569145 mm / 5³/₄"
 mit Schloß
 with lock · avec fermeture ·
 con cerradura · con serratura

 für Gefäßclips **06-04-560** bis **06-04-562** und
 Approximatoren **06-04-670**, **06-04-611** bis **06-04-615**
 und **06-04-671** bis **06-04-674**

 for Vessel Clips **06-04-560** to **06-04-562** and
 Approximators **06-04-670**, **06-04-611** to **06-04-615**
 and **06-04-671** to **06-04-674**

 pour les clips vasculaires de **06-04-560** à **06-04-562**
 et pour les approximateurs **06-04-670**, **06-04-611** à
06-04-615 et de **06-04-671** à **06-04-674**

 para los clips vasculares de **06-04-560** a **06-04-562**
 y para los aproximadores de **06-04-670**, de **06-04-611**
 a **06-04-615** y de **06-04-671** a **06-04-674**

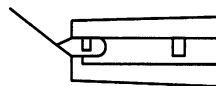

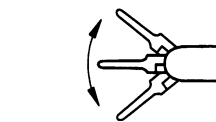

 per i clips vascolari da **06-04-560** a **06-04-562** e per
 approssimatori **06-04-670**, da **06-04-611** a **06-04-615**
 e da **06-04-671** a **06-04-674**

1/1

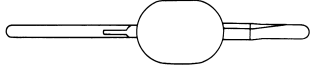
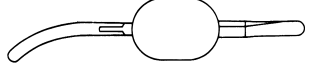

**MEHDORN****06-04-578**145 mm / 5³/₄"
 ohne Schloß
 without lock · sans fermeture
 sin cerradura · senza serratura

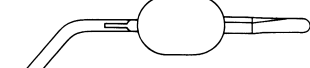

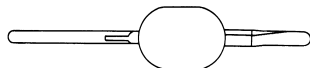

 für Gefäßclips **06-04-552** bis **06-04-558**
 for Vessel Clips **06-04-552** to **06-04-558**
 pour les clips vasculaires de **06-04-552** à **06-04-558**
 para los clips vasculares de **06-04-552** a **06-04-558**
 per i clips vascolari da **06-04-552** a **06-04-558**

Artikel-Nr. Schließkraft · Closing Force · Force de fermeture
 Cat. No. Fuerza de cierre · Forza di chiusura

06-05-010	50 g	MÜLLER	
06-05-020	80 g		
06-05-011	50 g	MÜLLER	
06-05-021	80 g		
06-05-012	50 g	MÜLLER	
06-05-022	80 g		
06-05-013	50 g	MÜLLER	
06-05-023	80 g		
06-05-014	50 g	MÜLLER	
06-05-024	80 g		
06-05-005	Fadenklemme Ligature Forceps · Pince à ligature · Pinza para ligadura · Pinze per legature	MÜLLER	
			1/1

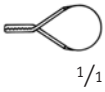
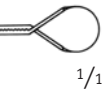
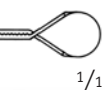
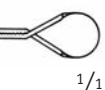

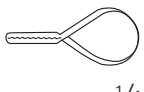
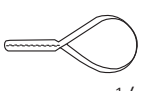
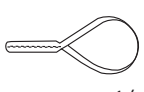
06-04-517	32 mm / 1 1/2" Mikro-Gefäß-Clip Micro Vessel Clip · Micro Clip vasculaire · Micro Clip vascular · Micro Clip vascolari	YASARGIL	
06-04-519	180 mm / 7" Anlegepinzette für Gefäßclips 06-04-517 Applying Forceps for vessel clips 06-04-517 Pince à appliquer pour les clips vasculaires 06-04-517 Pinza para aplicar los clips vasculares 06-04-517 Pinza per applicare i clips vascolari 06-04-517	YASARGIL	
			1/2

		Artikel-Nr. Cat. No.	Maullänge · Length of jaws · Longueur des mors Longitud de la boca · Lunghezza del morso
1/1 	 1/1	06-54-680	4 mm
	 1/1		
	 1/1		
	 1/1		
1/1 	 1/1	06-54-684	6 mm leicht gebogen <i>slightly curved · légèrement coudé · ligeramente acodado · leggermente curvo</i>
	 1/1	06-54-685	6 mm gebogen <i>curved · coudé · acodado · curvo</i>
	 1/1	06-54-686	6 mm abgewinkelt 45° <i>angled 45° · coudé en bas 45° · angulado hacia abajo 45° · angolata in giù 45°</i>
	 1/1	06-54-687	8 mm seitwärts abgewinkelt 45° <i>angled to side 45° · coudé vers le côté 45° curvo hacia un lado 45° · curvo lateralmente 45°</i>

Artikel-Nr.
Cat. No.

Gesamtlänge
Total length

06-54-688

140 mm / 5¹/₄"

06-54-689

180 mm / 7"

mit Sperre
with catch · avec fermeture ·
con cerradura · con serratura



1/2

06-54-690

180 mm / 7"

06-54-691

220 mm / 8³/₄"

mit Sperre
with catch · avec fermeture ·
con cerradura · con serratura



2/3



1/1

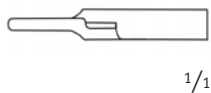

1/1

SCHWARTZ

 Artikel-Nr.
 Cat. No.

06-54-695

 Gesamtlänge
 Total length

25 mm / 1"

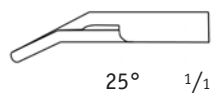
 Maullänge · length of jaw · longueur des mors ·
 longitud de la boca · lunghezza del morso
 10 mm

25° 1/1

SCHWARTZ

06-54-696

25 mm / 1"

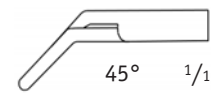
 Maullänge · length of jaw · longueur des mors ·
 longitud de la boca · lunghezza del morso
 10 mm

45° 1/1

SCHWARTZ

06-54-697

25 mm / 1"

 Maullänge · length of jaw · longueur des mors ·
 longitud de la boca · lunghezza del morso
 10 mm

1/2

SCHWARTZ

06-54-698

200 mm / 8"

 Anlegezange für Schwartz-Gefäßclips
 Applying forceps for Schwartz-Vessel Clips
 Pince à appliquer pour Schwartz-Clips vasculaires
 Pinza para aplicar Schwartz-Clips vasculares
 Pinza per applicare i Schwartz-Clips vascolari



Bulldogklemmen, Gefäßclips
Bulldog Clamps, Vessel Clips · Clamps Bulldog, Clips vasculaires
Clamps Bulldog, Clips vasculares · Pinze Bulldog, Clips vascolari

// 01

Atraumatische Gefäßklemmen
Atraumatic Vascular Clamps · Pincés vasculaires atraumatiques
Pinzas vasculares atraumáticas · Pinze vascolari atraumatiche

// 02

Atraumatische Pinzetten
Atraumatic Tissue Forceps · Pincés atraumatiques
Pinzas atraumáticas · Pinze atraumatiche

// 03

Rippensperrer
Rib Spreaders · Ecarteurs pour costaux
Separadores costales · Divaricatori costali

// 04

Atrium, Aorta-Instrumente
Atrium-, Aortic Instruments · Instruments pour l'oreillette et l'aorte
Instrumentos para el atrium y la aorta · Strumenti per atrio e aorta

// 05

Wundhaken, Wundspreizer
Retractors · Ecarteurs
Separadores · Divaricatori

// 06

Sonden, Dilatationsinstrumente
Probes, Instruments for dilatation · Sondes, Instruments pour la dilatation
Sondas, Instrumentos para la dilatación · Sonda, Strumenti a dilatazione

// 07

Mikro-Instrumente
Micro Instruments · Micro instruments
Instrumentos para microcirugía · strumenti per microchirurgia

// 08

Allgemeinchirurgische Instrumente
General surgery instruments · Instruments pour la chirurgie générale
Instrumentos para la cirugía general · Strumenti per chirurgia generale











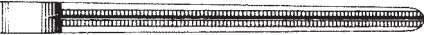

// 09

Orthopädische Instrumente
Orthopaedic Instruments · Instruments pour l'orthopédie
Instrumentos para ortopedia · Strumenti per ortopedia

// 10





Artikel-Nr. Cat. No.	Gesamtlänge Total length	PEAN	
06-52-444	140 mm / 5 ¹ / ₂ "	PEAN	 1/1
06-02-444	160 mm / 6 ¹ / ₄ "	PEAN	 1/1
06-52-448	180 mm / 7"	PEAN	 1/1
06-02-526	200 mm / 8"	PEAN	 1/1
06-02-532	265 mm / 10 ¹ / ₂ "	PEAN	 89 mm
06-02-534	280 mm / 11"	PEAN	 99 mm
06-52-445	140 mm / 5 ¹ / ₂ "	PEAN	 1/1
06-02-445	160 mm / 6 ¹ / ₄ "	PEAN	 1/1
06-52-449	180 mm / 7"	PEAN	 1/1
06-02-527	200 mm / 8"	PEAN	 1/1
06-02-533	260 mm / 10 ¹ / ₄ "	PEAN	 89 mm
06-02-535	275 mm / 10 ³ / ₄ "	PEAN	 99 mm

ATRAUMA



DE BAKEY

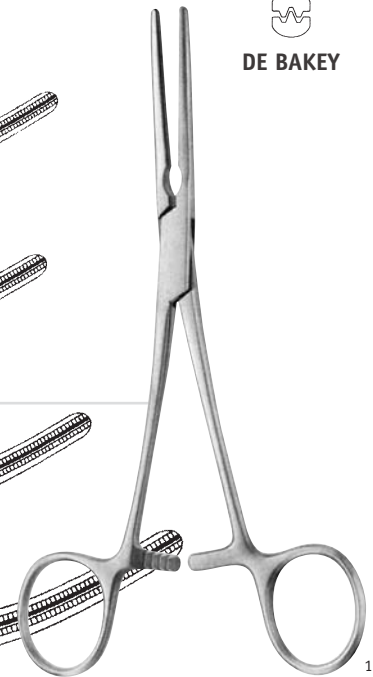

1/2

ATRAUMA

DE BAKEY

1/1

**HALSTEAD-
MOSQUITO**

 Artikel-Nr.
 Cat. No.

 Gesamtlänge
 Total length

06-02-440

120 mm / 4³/₄"

1/1

**HALSTEAD-
MOSQUITO**

06-02-441

120 mm / 4³/₄"

1/1

**HALSTEAD-
MOSQUITO**

06-02-442

150 mm / 6"



1/1

**HALSTEAD-
MOSQUITO**

06-02-443

150 mm / 6"

1/2

ATRAUMA

DE BAKEY

1/1

RANKIN

06-52-442

160 mm / 6¹/₄"

1/1

RANKIN

06-52-443

160 mm / 6¹/₄"

1/2



ATRAUMA



DE BAKEY



2



Artikel-Nr.
 Cat. No.

Gesamtlänge
 Total length

06-02-528	230 mm / 9"
06-02-529	235 mm / 9 ¹ / ₄ "
06-02-530	245 mm / 9 ³ / ₄ "

HOPT

1/1

40 mm

HOPT

1/1

50 mm

HOPT

1/1

60 mm

1/1

ATRAUMA

DE BAKEY

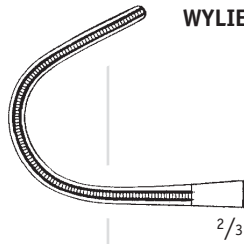
 $1/3$

WYLIE
 $2/3$

 Artikel-Nr.
 Cat. No.

06-52-500

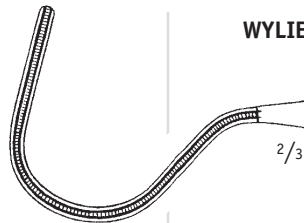
 Gesamtlänge
 Total length

 210 mm / 8 $1/4$ "

WYLIE
 $2/3$
06-52-501

 220 mm / 8 $3/4$ "

ATRAUMA

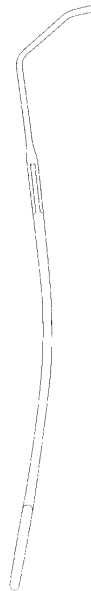
DE BAKEY

 $1/3$

**GLOVER-
DE BAKEY**
 $2/3$
06-52-502

230 mm / 9"

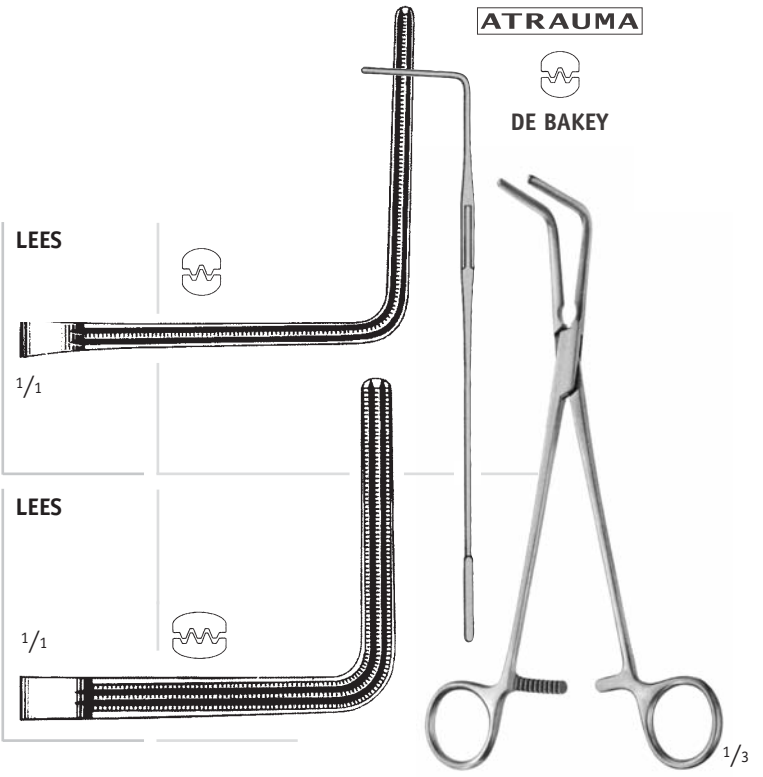
Artikel-Nr. Cat. No.	Gesamtlänge Total length
06-02-573T	230 mm / 9" Titan · Titanium · Titane · Titanio · Titanio
06-02-573	230 mm / 9" Bronchusklemme Bronchus Forceps · Pince pour bronches Pinza clamps bronquiales · Pinze per bronchi
06-52-573T	250 mm / 10" Titan · Titanium · Titane · Titanio · Titanio
06-52-573	250 mm / 10" Bronchusklemme Bronchus Forceps · Pince pour bronches Pinza clamps bronquiales · Pinze per bronchi

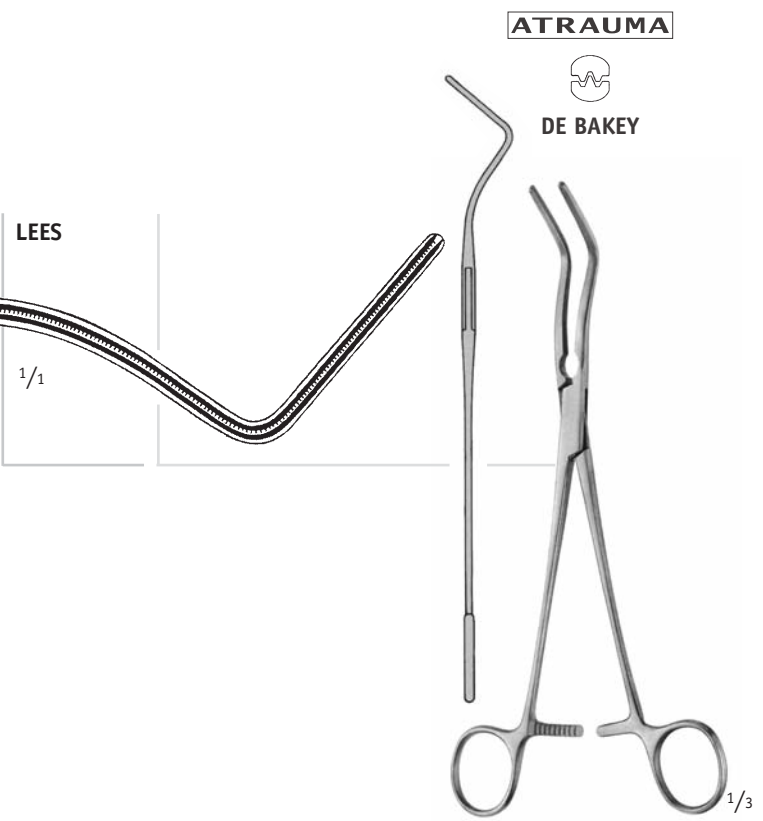

06-02-574T	250 mm / 10" Titan · Titanium · Titane · Titanio · Titanio
06-02-574	250 mm / 10" Bronchusklemme Bronchus Forceps · Pince pour bronches Pinza clamps bronquiales · Pinze per bronchi



2

ATRAUMA

DE BAKEY

1/2

DE BAKEY

 Artikel-Nr.
 Cat. No.

 Gesamtlänge
 Total length

06-02-540

 120 mm / 4³/₄"

 Bulldogklemme mit Ringgriff
 Ring Bulldog clamp
 Clamp Bulldog, manche à anneau
 Clamp Bulldog con mango de anillo
 Pinze Bulldog con manico di anello

DE BAKEY
06-02-541

 120 mm / 4³/₄"

 Bulldogklemme mit Ringgriff
 Ring Bulldog clamp
 Clamp Bulldog, manche à anneau
 Clamp Bulldog con mango de anillo
 Pinze Bulldog con manico di anello

ATRAUMA

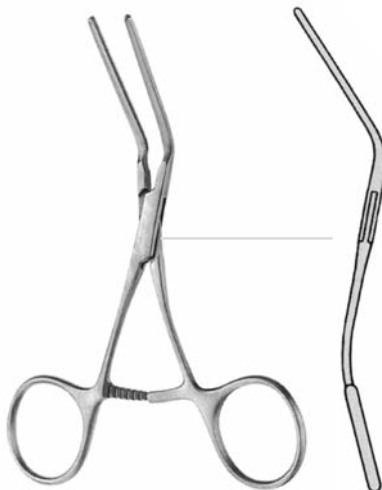
DE BAKEY

1/2

DE BAKEY
06-02-543

 120 mm / 4³/₄"

 Bulldogklemme mit Ringgriff
 Ring Bulldog clamp
 Clamp Bulldog, manche à anneau
 Clamp Bulldog con mango de anillo
 Pinze Bulldog con manico di anello

Artikel-Nr.
 Cat. No.

Gesamtlänge
 Total length

06-02-544

100 mm / 4"

Bulldogklemme mit Ringgriff
 Ring Bulldog clamp
 Clamp Bulldog, manche à anneau
 Clamp Bulldog con mango de anillo
 Pinze Bulldog con manico di anello

DE BAKEY



ATRAUMA



DE BAKEY

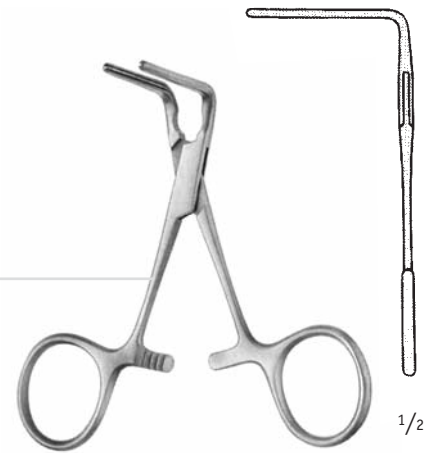

06-02-542

120 mm / 4³/₄"

Bulldogklemme mit Ringgriff
 Ring Bulldog clamp
 Clamp Bulldog, manche à anneau
 Clamp Bulldog con mango de anillo
 Pinze Bulldog con manico di anello

DE BAKEY

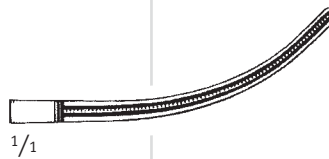

ATRAUMA



DE BAKEY



ATRAUMA

DE BAKEY

1/2

HARKEN

 Artikel-Nr.
 Cat. No.

06-02-521

 Gesamtlänge
 Total length

 240 mm / 9¹/₂"

 Aurikelklemme
 Auricle Clamp
 Pince oreilletta
 Pinza para auricula
 Pinze ventricolari

2/3

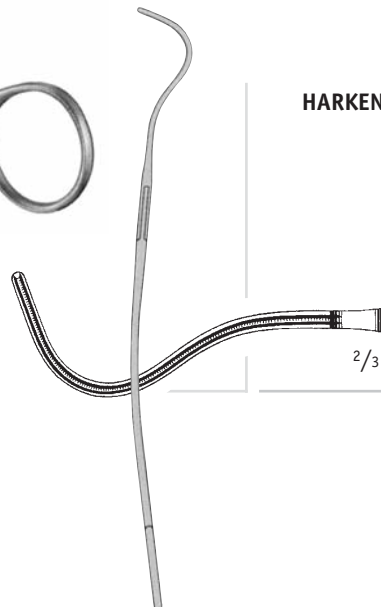
HARKEN
06-02-522

 240 mm / 9¹/₂"

 Aurikelklemme
 Auricle Clamp
 Pince oreilletta
 Pinza para auricula
 Pinze ventricolari

2/3

Artikel-Nr.
 Cat. No.

Gesamtlänge
 Total length

06-02-523

240 mm / 9¹/₂"

Aurikelklemme
 Auricle Clamp
 Pince oreilletta
 Pinza para aurícula
 Pinze ventricolari

HARKEN



ATRAUMA



DE BAKEY

06-02-524

240 mm / 9¹/₂"

Aurikelklemme
 Auricle Clamp
 Pince oreilletta
 Pinza para aurícula
 Pinze ventricolari

HARKEN

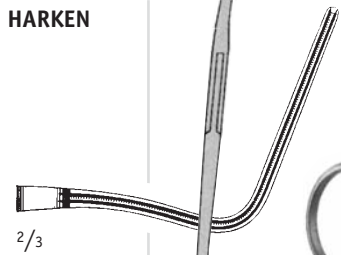

1/2

ATRAUMA

DE BAKEY

1/3

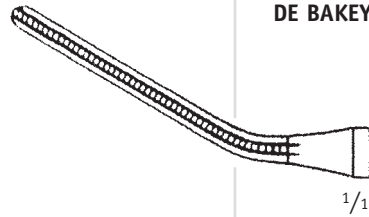
DE BAKEY

1/1

 Artikel-Nr.
 Cat. No.

06-52-550

 Gesamtlänge
 Total length

150 mm / 6"

 Coarctationsklemme
 Coarctation Clamp
 Pince pour coarctation
 Pinza para coarctación
 Pinze per coartazione

ATRAUMA

DE BAKEY

DE BAKEY

1/1

06-52-551

 160 mm / 6¹/₄"

 Coarctationsklemme
 Coarctation Clamp
 Pince pour coarctation
 Pinza para coarctación
 Pinze per coartazione

ATRAUMA

DE BAKEY

1/3



1/3

DE BAKEY

1/1

06-02-552

 170 mm / 6¹/₂"

 Coarctationsklemme
 Coarctation Clamp
 Pince pour coarctation
 Pinza para coarctación
 Pinze per coartazione

ATRAUMA



DE BAKEY

Artikel-Nr.
 Cat. No.

Gesamtlänge
 Total length

06-52-552

150 mm / 6"

Coarctationsklemme
 Coarctation Clamp
 Pince pour coarctation
 Pinza para coarctación
 Pinze per coartazione

DE BAKEY



1/1



1/2

ATRAUMA



DE BAKEY

06-02-553

170 mm / 6 1/2"

Coarctationsklemme
 Coarctation Clamp
 Pince pour coarctation
 Pinza para coarctación
 Pinze per coartazione

DE BAKEY

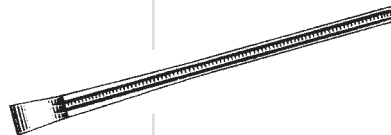

1/1



1/2

ATRAUMA

DE BAKEY

 $\frac{1}{2}$
DE BAKEY

 $\frac{1}{1}$

 Artikel-Nr.
 Cat. No.

06-02-554

 Gesamtlänge
 Total length

 170 mm / 6³/₄"

 Coarctationsklemme
 Coarctation Clamp
 Pince pour coarctation
 Pinza para coarctación
 Pinze per coartazione

ATRAUMA

DE BAKEY

 $\frac{1}{2}$
DE BAKEY

 $\frac{1}{1}$
06-52-553

 170 mm / 6³/₄"

 Coarctationsklemme
 Coarctation Clamp
 Pince pour coarctation
 Pinza para coarctación
 Pinze per coartazione

ATRAUMA



DE BAKEY

Artikel-Nr.
 Cat. No.

Gesamtlänge
 Total length

06-02-569

145 mm / 5 1/2"

Coarctationsklemme
 Coarctation Clamp
 Pince pour coarctation
 Pinza para coarctación
 Pinze per coartazione

DE BAKEY

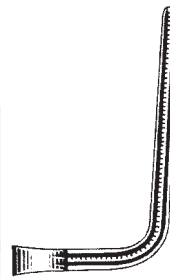

1/1
 90°



06-02-568

155 mm / 6"

Coarctationsklemme
 Coarctation Clamp
 Pince pour coarctation
 Pinza para coarctación
 Pinze per coartazione

DE BAKEY

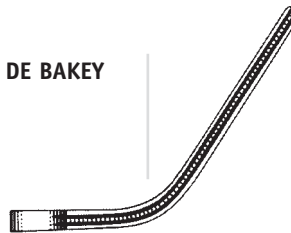

1/1
 60°



1/2

06-02-567

160 mm / 6 1/4"

Coarctationsklemme
 Coarctation Clamp
 Pince pour coarctation
 Pinza para coarctación
 Pinze per coartazione

DE BAKEY



1/1
 30°



ATRAUMA

DE BAKEY

DE BAKEY

 Artikel-Nr.
 Cat. No.

 Gesamtlänge
 Total length

06-02-452

200 mm / 8"



1/1

 Coarctationsklemme
 Coarctation Clamp
 Pince pour coarctation
 Pinza para coarctación
 Pinze per coartazione

DE BAKEY
06-02-454

 225 mm / 8³/₄"

1/1

 Coarctationsklemme
 Coarctation Clamp
 Pince pour coarctation
 Pinza para coarctación
 Pinze per coartazione

DE BAKEY
06-02-456

 260 mm / 10¹/₄"

1/1

 Coarctationsklemme
 Coarctation Clamp
 Pince pour coarctation
 Pinza para coarctación
 Pinze per coartazione

ATRAUMA

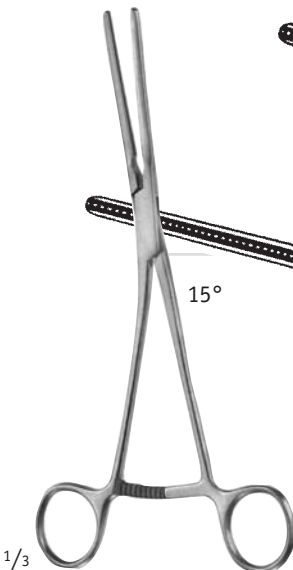
DE BAKEY

DE BAKEY
06-02-453

200 mm / 8"



1/1

 Coarctationsklemme
 Coarctation Clamp
 Pince pour coarctation
 Pinza para coarctación
 Pinze per coartazione

DE BAKEY
06-02-455

 225 mm / 8³/₄"

1/1

 Coarctationsklemme
 Coarctation Clamp
 Pince pour coarctation
 Pinza para coarctación
 Pinze per coartazione

DE BAKEY
06-02-457

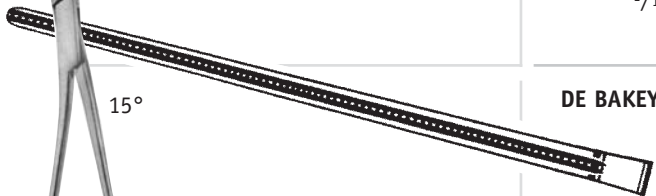
 260 mm / 10¹/₄"

1/1

 Coarctationsklemme
 Coarctation Clamp
 Pince pour coarctation
 Pinza para coarctación
 Pinze per coartazione

Artikel-Nr. Cat. No.	Gesamtlänge Total length
06-52-456T	210 mm / 8 ¹ / ₄ " Titan · Titanium · Titane · Titanio · Titanio
06-52-456	210 mm / 8 ¹ / ₄ " Coarctationsklemme Coarctation Clamp · Pince pour coarctation Pinza para coarctación · Pinze per coartazione
06-52-457T	220 mm / 8 ³ / ₄ " Titan · Titanium · Titane · Titanio · Titanio
06-52-457	220 mm / 8 ³ / ₄ " Coarctationsklemme Coarctation Clamp · Pince pour coarctation Pinza para coarctación · Pinze per coartazione

POTTS

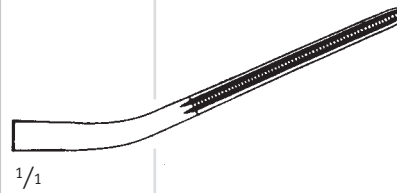

POTTS

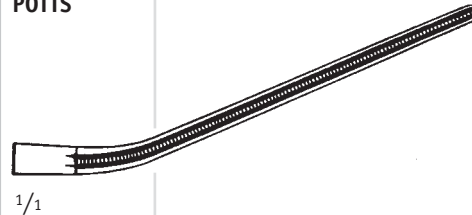

ATRAUMA



DE BAKEY



1/3

06-52-458	210 mm / 8 ¹ / ₄ " Coarctationsklemme Coarctation Clamp Pince pour coarctation Pinza para coarctación Pinze per coartazione
06-52-459	220 mm / 8 ³ / ₄ " Coarctationsklemme Coarctation Clamp Pince pour coarctation Pinza para coarctación Pinze per coartazione

POTTS

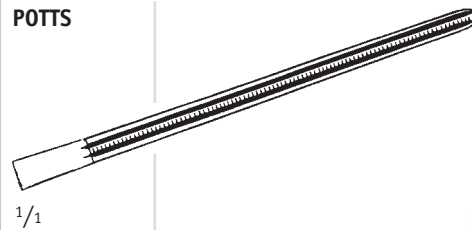

POTTS

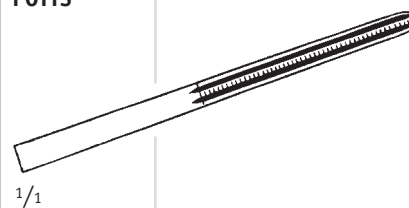

ATRAUMA



DE BAKEY



1/3

ATRAUMA

DE BAKEY

POTTS

 $\frac{2}{3}$

 Artikel-Nr.
 Cat. No.

06-52-503

 Gesamtlänge
 Total length

 210 mm / 8 $\frac{1}{4}$ "

 Coarctationsklemme
 Coarctation Clamp
 Pince pour coarctation
 Pinza para coarctación
 Pinze per coartazione

POTTS

 $\frac{2}{3}$
06-52-504

230 mm / 9"

 Coarctationsklemme
 Coarctation Clamp
 Pince pour coarctation
 Pinza para coarctación
 Pinze per coartazione

POTTS

 $\frac{2}{3}$
06-52-505

 270 mm / 10 $\frac{1}{2}$ "

 Coarctationsklemme
 Coarctation Clamp
 Pince pour coarctation
 Pinza para coarctación
 Pinze per coartazione

POTTS

 $\frac{2}{3}$
06-52-506

 310 mm / 12 $\frac{1}{4}$ "

 Coarctationsklemme
 Coarctation Clamp
 Pince pour coarctation
 Pinza para coarctación
 Pinze per coartazione

ATRAUMA



DE BAKEY



2



Artikel-Nr. Cat. No.	Gesamtlänge Total length
06-52-507	210 mm / 8 ¹ / ₄ "
	Coarctationsklemme Coarctation Clamp Pince pour coarctation Pinza para coarctación Pinze per coartazione
06-52-508	230 mm / 9"
	Coarctationsklemme Coarctation Clamp Pince pour coarctation Pinza para coarctación Pinze per coartazione
06-52-509	270 mm / 10 ¹ / ₂ "
	Coarctationsklemme Coarctation Clamp Pince pour coarctation Pinza para coarctación Pinze per coartazione
06-52-510	310 mm / 12 ¹ / ₄ "
	Coarctationsklemme Coarctation Clamp Pince pour coarctation Pinza para coarctación Pinze per coartazione

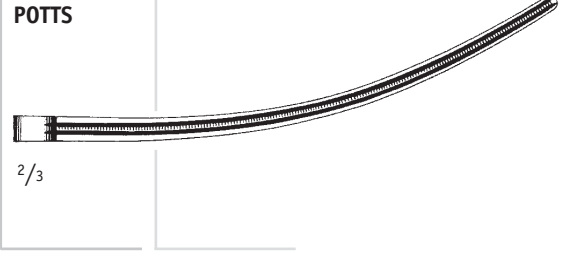
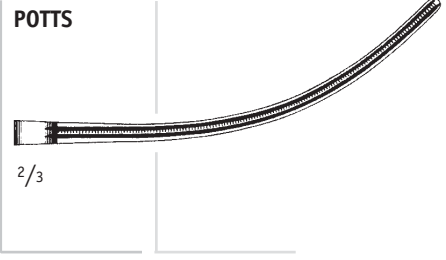
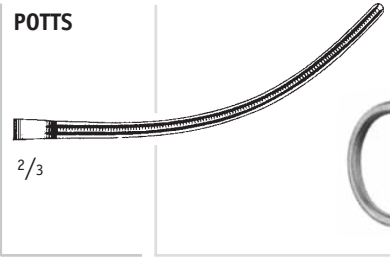
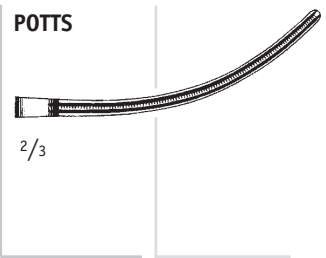

ATRAUMA

DE BAKEY

GLOVER

 Artikel-Nr.
 Cat. No.

 Gesamtlänge
 Total length

06-02-458T

 210 mm / 8¹/₄"

Titan · Titanium · Titane · Titanio · Titanio

06-02-458

 210 mm / 8¹/₄"

 Anastomosenklemme
 Anastomosis Clamp · Pince à anastomose
 Pinza para anastomosis · Pinze per anastomosi

1/1

GLOVER
06-02-459T

 240 mm / 9¹/₂"

Titan · Titanium · Titane · Titanio · Titanio

06-02-459

 240 mm / 9¹/₂"

 Anastomosenklemme
 Anastomosis Clamp · Pince à anastomose
 Pinza para anastomosis · Pinze per anastomosi

1/1

ATRAUMA

DE BAKEY

GLOVER
06-02-461

180 mm / 7"

 Anastomosenklemme
 Anastomosis Clamp
 Pince à anastomose
 Pinza para anastomosis
 Pinze per anastomosi

1/1

GLOVER
06-02-462

 220 mm / 8³/₄"

 Anastomosenklemme
 Anastomosis Clamp
 Pince à anastomose
 Pinza para anastomosis
 Pinze per anastomosi

1/1

ATRAUMA



DE BAKEY

Artikel-Nr.
 Cat. No.

Gesamtlänge
 Total length

06-02-460T

210 mm / 8¹/₄"

Titan · Titanium · Titane · Titanio · Titanio

06-02-460

210 mm / 8¹/₄"

Anastomosenklemme
Anastomosis Clamp · Pince à anastomose
Pinza para anastomosis · Pinze per anastomosi

GLOVER



ATRAUMA



DE BAKEY

06-52-463T

260 mm / 10¹/₄"

Titan · Titanium · Titane · Titanio · Titanio

06-52-463

260 mm / 10¹/₄"

Anastomosenklemme
Anastomosis Clamp · Pince à anastomose
Pinza para anastomosis · Pinze per anastomosi

GLOVER





2

ATRAUMA**DE BAKEY**

1/2

DERRA

2/3

 Artikel-Nr.
 Cat. No.

 Gesamtlänge
 Total length
06-02-559T160 mm / 6¹/₄"

Titan · Titanium · Titane · Titanio · Titanio

06-02-559160 mm / 6¹/₄"
 Anastomosenklemme, Kindergrößen
Anastomosis Clamp, pediatric
Pince à anastomose, pédiatrique
Pinza para anastomosis, pediátricas
Pinze per anastomosi, pediatriche
DERRA

2/3

06-02-560T170 mm / 6³/₄"

Titan · Titanium · Titane · Titanio · Titanio

06-02-560170 mm / 6³/₄"
 Anastomosenklemme, Kindergrößen
Anastomosis Clamp, pediatric
Pince à anastomose, pédiatrique
Pinza para anastomosis, pediátricas
Pinze per anastomosi, pediatriche
DERRA

2/3

06-02-561T

180 mm / 7"

Titan · Titanium · Titane · Titanio · Titanio

06-02-561

180 mm / 7"

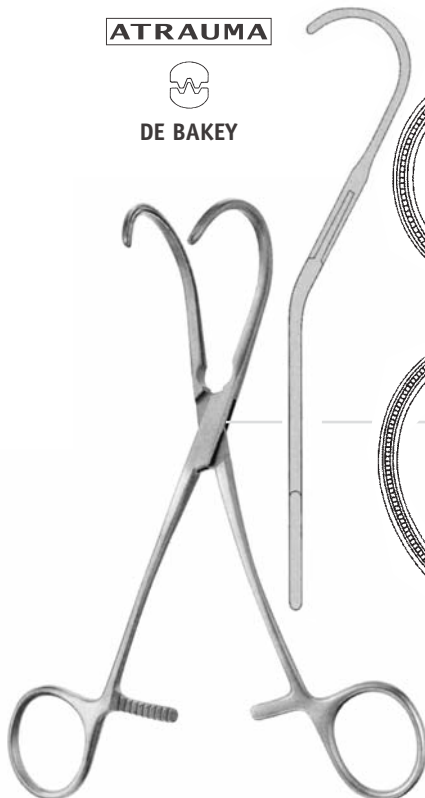
 Anastomosenklemme, Kindergrößen
Anastomosis Clamp, pediatric
Pince à anastomose, pédiatrique
Pinza para anastomosis, pediátricas
Pinze per anastomosi, pediatriche
ATRAUMA**DE BAKEY**

1/2

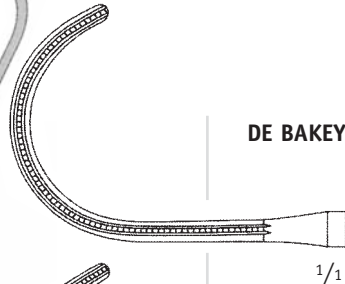
DE BAKEY

1/1

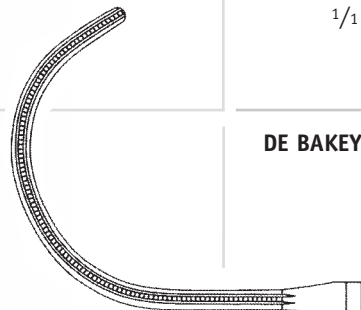
06-02-557160 mm / 6¹/₄"
 Anastomosenklemme
Anastomosis Clamp
Pince à anastomose
Pinza para anastomosis
Pinze per anastomosi
DE BAKEY

1/1

06-02-558170 mm / 6³/₄"
 Anastomosenklemme
Anastomosis Clamp
Pince à anastomose
Pinza para anastomosis
Pinze per anastomosi

ATRAUMA



DE BAKEY



2



1/2

Artikel-Nr. Cat. No.	Gesamtlänge Total length
06-52-520	165 mm / 6 ¹ / ₂ "
Anastomosenklemme Anastomosis Clamp Pince à anastomose Pinza para anastomosis Pinze per anastomosi	
06-52-521	165 mm / 6 ¹ / ₂ "
Anastomosenklemme Anastomosis Clamp Pince à anastomose Pinza para anastomosis Pinze per anastomosi	
06-52-522	180 mm / 7"
Anastomosenklemme Anastomosis Clamp Pince à anastomose Pinza para anastomosis Pinze per anastomosi	
06-52-523	180 mm / 7"
Anastomosenklemme Anastomosis Clamp Pince à anastomose Pinza para anastomosis Pinze per anastomosi	

**DE BAKEY
REYNOLDS**

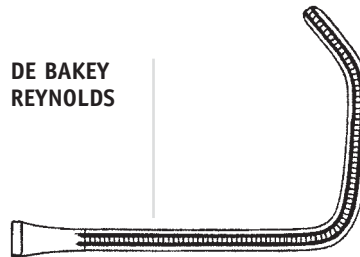

1/1

**DE BAKEY
REYNOLDS**



1/1

**DE BAKEY
REYNOLDS**



1/1

**DE BAKEY
REYNOLDS**



1/1

ATRAUMA

DE BAKEY

DE BAKEY

 Artikel-Nr.
 Cat. No.

 Gesamtlänge
 Total length

06-52-452

 190 mm / 7¹/₂"

 Peripheal-Gefäßklemme
 Peripheal Vascular Clamp
 Pince vasculaires périphériques
 Pinza para vasos periféricos
 Pinze vascolari per vasi periferici

DE BAKEY

06-52-454

 220 mm / 8³/₄"

 Peripheal-Gefäßklemme
 Peripheal Vascular Clamp
 Pince vasculaires périphériques
 Pinza para vasos periféricos
 Pinze vascolari per vasi periferici

ATRAUMA

DE BAKEY

DE BAKEY

06-52-453

 195 mm / 7¹/₂"

 Peripheal-Gefäßklemme
 Peripheal Vascular Clamp
 Pince vasculaires périphériques
 Pinza para vasos periféricos
 Pinze vascolari per vasi periferici

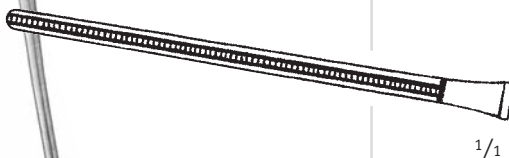
DE BAKEY

06-52-455

 220 mm / 8³/₄"

 Peripheal-Gefäßklemme
 Peripheal Vascular Clamp
 Pince vasculaires périphériques
 Pinza para vasos periféricos
 Pinze vascolari per vasi periferici

ATRAUMA



DE BAKEY

Artikel-Nr.
 Cat. No.

Gesamtlänge
 Total length

06-02-466

190 mm / 7¹/₂"

Peripheal-Gefäßklemme
Peripheal Vascular Clamp
Pince vasculaires périphériques
Pinza para vasos periféricos
Pinze vascolari per vasi periferici

DE BAKEY

1/1



1/2

ATRAUMA



DE BAKEY

06-52-511

265 mm / 10¹/₂"

Peripheal-Gefäßklemme
Peripheal Vascular Clamp
Pince vasculaires périphériques
Pinza para vasos periféricos
Pinze vascolari per vasi periferici

DE BAKEY

1/1

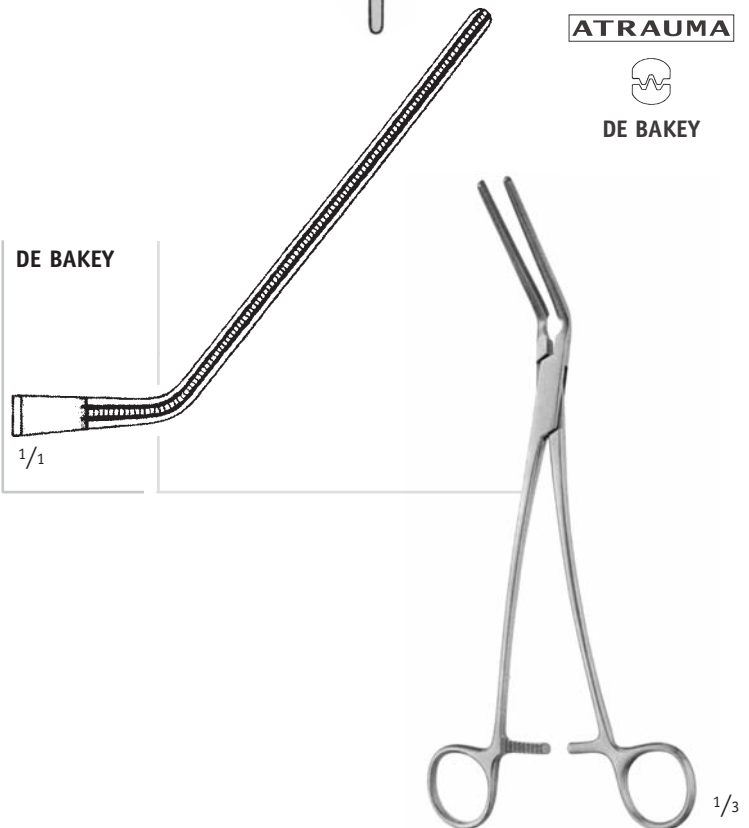

1/3

ATRAUMA

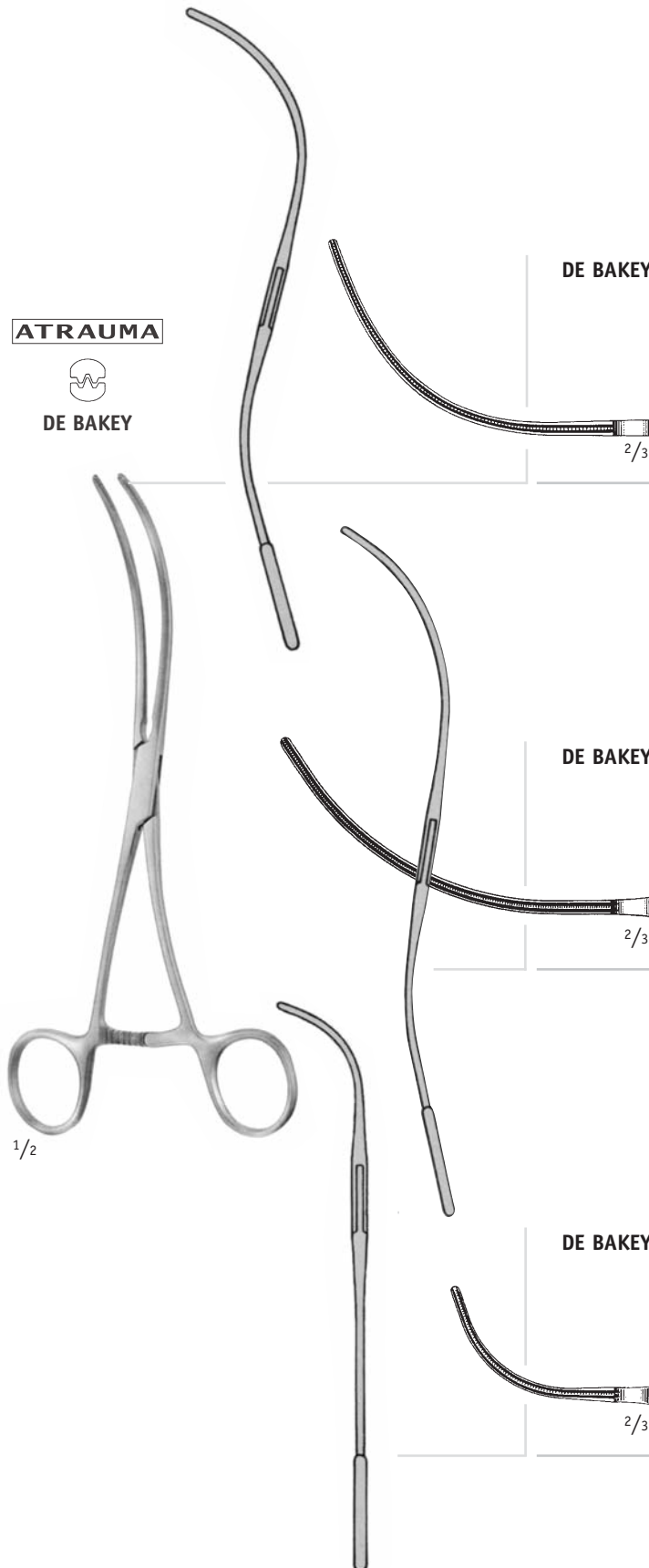
DE BAKEY

 Artikel-Nr.
 Cat. No.

 Gesamtlänge
 Total length

DE BAKEY
06-02-464T

 190 mm / 7¹/₂"

Titan · Titanium · Titane · Titanio · Titanio

06-02-464

 190 mm / 7¹/₂"

 Peripheal-Gefäßklemme
 Peripheal Vascular Clamp
 Pincès vasculaires périphériques
 Pinza para vasos periféricos
 Pinze vascolari per vasi periferici

DE BAKEY
06-02-465T

200 mm / 8"

Titan · Titanium · Titane · Titanio · Titanio

06-02-465

200 mm / 8"

 Peripheal-Gefäßklemme
 Peripheal Vascular Clamp
 Pincès vasculaires périphériques
 Pinza para vasos periféricos
 Pinze vascolari per vasi periferici

DE BAKEY
06-02-463T

 160 mm / 6¹/₄"

Titan · Titanium · Titane · Titanio · Titanio

06-02-463

 160 mm / 6¹/₄"

 Peripheal-Gefäßklemme
 Peripheal Vascular Clamp
 Pincès vasculaires périphériques
 Pinza para vasos periféricos
 Pinze vascolari per vasi periferici

Artikel-Nr. Cat. No.	Gesamtlänge Total length
06-52-464	170 mm / 6 ¹ / ₂ "
Peripheal-Gefäßklemme Peripheal Vascular Clamp Pince vasculaires périphériques Pinza para vasos periféricos Pinze vascolari per vasi perifici	
06-52-465	180 mm / 7"
Peripheal-Gefäßklemme Peripheal Vascular Clamp Pince vasculaires périphériques Pinza para vasos periféricos Pinze vascolari per vasi perifici	
06-52-466	190 mm / 7 ¹ / ₄ "
Peripheal-Gefäßklemme Peripheal Vascular Clamp Pince vasculaires périphériques Pinza para vasos periféricos Pinze vascolari per vasi perifici	

DALE



DALE

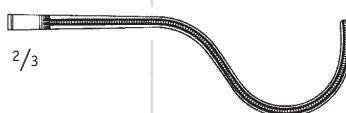

DALE

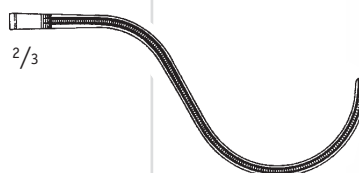

ATRAUMA



DE BAKEY



1/2

ATRAUMA



DE BAKEY



1/2

06-52-467	180 mm / 7"
Peripheal-Gefäßklemme Peripheal Vascular Clamp Pince vasculaires périphériques Pinza para vasos periféricos Pinze vascolari per vasi perifici	

DALE



ATRAUMA

DE BAKEY

1/2

**MARTIN-
WYLIE**

1/1

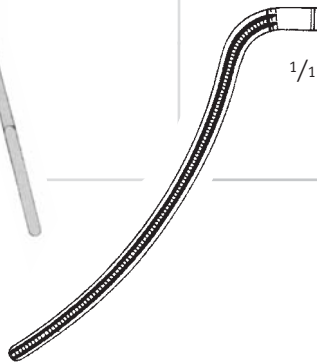
 Artikel-Nr.
 Cat. No.

06-52-512

 Gesamtlänge
 Total length

 160 mm / 6¹/₄"

 Peripheal-Gefäßklemme
 Peripheal Vascular Clamp
 Pince vasculaires périphériques
 Pinza para vasos periféricos
 Pinze vascolari per vasi periferici

**MARTIN-
WYLIE**

1/1

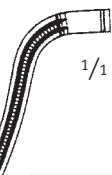
06-52-513

 170 mm / 6¹/₂"

 Peripheal-Gefäßklemme
 Peripheal Vascular Clamp
 Pince vasculaires périphériques
 Pinza para vasos periféricos
 Pinze vascolari per vasi periferici



Artikel-Nr.
 Cat. No.

Gesamtlänge
 Total length

06-52-514

180 mm / 7"

Peripheal-Gefäßklemme
 Peripheal Vascular Clamp
 Pince vasculaires périphériques
 Pinza para vasos periféricos
 Pinze vascolari per vasi periferici

**MARTIN-
 WYLIE**

1/1

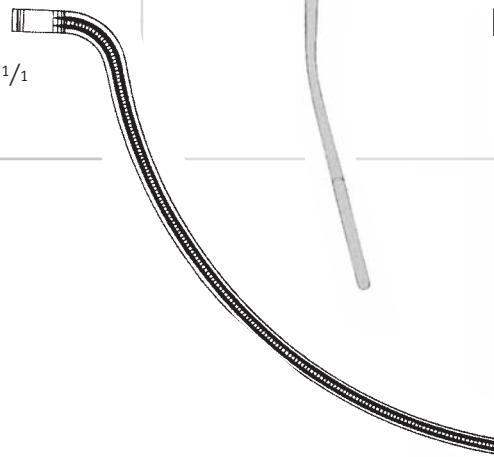

ATRAUMA



DE BAKEY

06-52-515

200 mm / 8"

Peripheal-Gefäßklemme
 Peripheal Vascular Clamp
 Pince vasculaires périphériques
 Pinza para vasos periféricos
 Pinze vascolari per vasi periferici

**MARTIN-
 WYLIE**

1/1

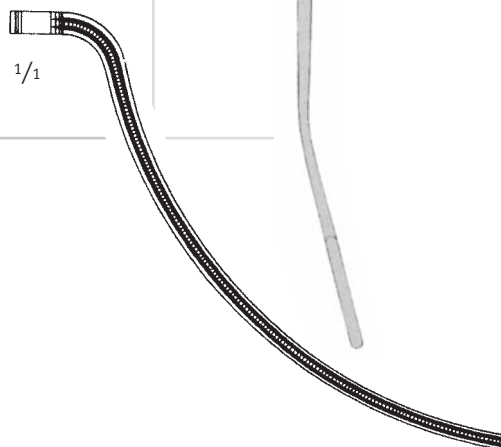

1/2

ATRAUMA

DE BAKEY

1/2

DARDIK

1/1

 Artikel-Nr.
 Cat. No.

06-03-300

 Gesamtlänge
 Total length

150 mm / 6"

Atraumatische Mehrweckklemme, extrem leicht
Atraumatic Multi-Purpose Clamp, extremely light
Pince atraumatique polyvalente, extrêmement légère
Pinza clamps atraumática, especialmente ligero
Pinze atraumatiche per diversi usi, estremamente leggera

DARDIK

 1/1
 15°

06-03-301

150 mm / 6"

Atraumatische Mehrweckklemme, extrem leicht
Atraumatic Multi-Purpose Clamp, extremely light
Pince atraumatique polyvalente, extrêmement légère
Pinza clamps atraumática, especialmente ligero
Pinze atraumatiche per diversi usi, estremamente leggera

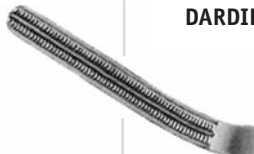
DARDIK

 1/1
 30°

06-03-302

150 mm / 6"

Atraumatische Mehrweckklemme, extrem leicht
Atraumatic Multi-Purpose Clamp, extremely light
Pince atraumatique polyvalente, extrêmement légère
Pinza clamps atraumática, especialmente ligero
Pinze atraumatiche per diversi usi, estremamente leggera

DARDIK

 1/1
 45°

06-03-303

 145 mm / 5³/₄"

Atraumatische Mehrweckklemme, extrem leicht
Atraumatic Multi-Purpose Clamp, extremely light
Pince atraumatique polyvalente, extrêmement légère
Pinza clamps atraumática, especialmente ligero
Pinze atraumatiche per diversi usi, estremamente leggera







DARDIK

 1/1
 90°

06-03-304

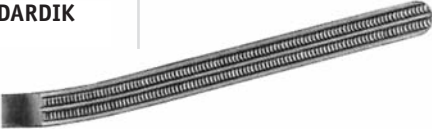
130 mm / 5"

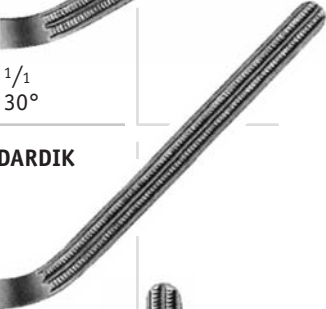
Atraumatische Mehrweckklemme, extrem leicht
Atraumatic Multi-Purpose Clamp, extremely light
Pince atraumatique polyvalente, extrêmement légère
Pinza clamps atraumática, especialmente ligero
Pinze atraumatiche per diversi usi, estremamente leggera

Artikel-Nr. Cat. No.	Gesamtlänge Total length		
06-03-310	170 mm / 6 ³ / ₄ " Atraumatische Mehrzweckklemme, extrem leicht <i>Atraumatic Multi-Purpose Clamp, extremely light</i> <i>Pince atraumatique polyvalente, extrêmement légère</i> <i>Pinza clamps atraumática, especialmente ligero</i> <i>Pinze atraumatiche per diversi usi, estremamente leggera</i>	DARDIK  1/1	<div data-bbox="1214 309 1382 338" style="border: 1px solid black; padding: 2px; display: inline-block;">ATRAUMA</div>  DE BAKEY 
06-03-311	170 mm / 6 ³ / ₄ " Atraumatische Mehrzweckklemme, extrem leicht <i>Atraumatic Multi-Purpose Clamp, extremely light</i> <i>Pince atraumatique polyvalente, extrêmement légère</i> <i>Pinza clamps atraumática, especialmente ligero</i> <i>Pinze atraumatiche per diversi usi, estremamente leggera</i>	DARDIK  1/1 15°	
06-03-312	170 mm / 6 ³ / ₄ " Atraumatische Mehrzweckklemme, extrem leicht <i>Atraumatic Multi-Purpose Clamp, extremely light</i> <i>Pince atraumatique polyvalente, extrêmement légère</i> <i>Pinza clamps atraumática, especialmente ligero</i> <i>Pinze atraumatiche per diversi usi, estremamente leggera</i>	DARDIK  1/1 30°	
06-03-313	160 mm / 6 ¹ / ₄ " Atraumatische Mehrzweckklemme, extrem leicht <i>Atraumatic Multi-Purpose Clamp, extremely light</i> <i>Pince atraumatique polyvalente, extrêmement légère</i> <i>Pinza clamps atraumática, especialmente ligero</i> <i>Pinze atraumatiche per diversi usi, estremamente leggera</i>	DARDIK  1/1 45°	
06-03-314	135 mm / 5 ¹ / ₄ " Atraumatische Mehrzweckklemme, extrem leicht <i>Atraumatic Multi-Purpose Clamp, extremely light</i> <i>Pince atraumatique polyvalente, extrêmement légère</i> <i>Pinza clamps atraumática, especialmente ligero</i> <i>Pinze atraumatiche per diversi usi, estremamente leggera</i>	DARDIK  1/1 90°	

ATRAUMA

DE BAKEY

1/2

BAINBRIDGE

 Artikel-Nr.
 Cat. No.

 Gesamtlänge
 Total length

06-02-446

150 mm / 6"



1/1

 Atraumatische Mehrzweckklemme
 Atraumatic Multi-Purpose Clamp
 Pince atraumatique polyvalente
 Pinza clamps atraumática
 Pinze atraumatiche per diversi usi

BAINBRIDGE
06-02-448

 185 mm / 7¹/₄"

1/1

 Atraumatische Mehrzweckklemme
 Atraumatic Multi-Purpose Clamp
 Pince atraumatique polyvalente
 Pinza clamps atraumática
 Pinze atraumatiche per diversi usi

BAINBRIDGE
06-02-447

150 mm / 6"



1/1

 Atraumatische Mehrzweckklemme
 Atraumatic Multi-Purpose Clamp
 Pince atraumatique polyvalente
 Pinza clamps atraumática
 Pinze atraumatiche per diversi usi

BAINBRIDGE
06-02-449

 185 mm / 7¹/₄"

1/1

 Atraumatische Mehrzweckklemme
 Atraumatic Multi-Purpose Clamp
 Pince atraumatique polyvalente
 Pinza clamps atraumática
 Pinze atraumatiche per diversi usi

ATRAUMA



DE BAKEY



2

Artikel-Nr.
 Cat. No.

Gesamtlänge
 Total length

06-02-469T	190 mm / 7 1/2" Titan · Titanium · Titane · Titanio · Titanio
06-02-469	190 mm / 7 1/2" Atraumatische Mehrzweckklemme <i>Atraumatic Multi-Purpose Clamp</i> <i>Pince atraumatique polyvalente</i> <i>Pinza clamps atraumática</i> <i>Pinze atraumatiche per diversi usi</i>

LELAND-JONES

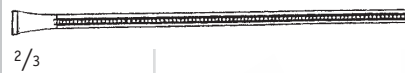

2/3

06-02-467T	190 mm / 7 1/2" Titan · Titanium · Titane · Titanio · Titanio
06-02-467	190 mm / 7 1/2" Atraumatische Mehrzweckklemme <i>Atraumatic Multi-Purpose Clamp</i> <i>Pince atraumatique polyvalente</i> <i>Pinza clamps atraumática</i> <i>Pinze atraumatiche per diversi usi</i>

LELAND-JONES



2/3
 45°

06-02-468T	190 mm / 7 1/2" Titan · Titanium · Titane · Titanio · Titanio
06-02-468	190 mm / 7 1/2" Atraumatische Mehrzweckklemme <i>Atraumatic Multi-Purpose Clamp</i> <i>Pince atraumatique polyvalente</i> <i>Pinza clamps atraumática</i> <i>Pinze atraumatiche per diversi usi</i>

LELAND-JONES



2/3
 30°



1/2

ATRAUMA

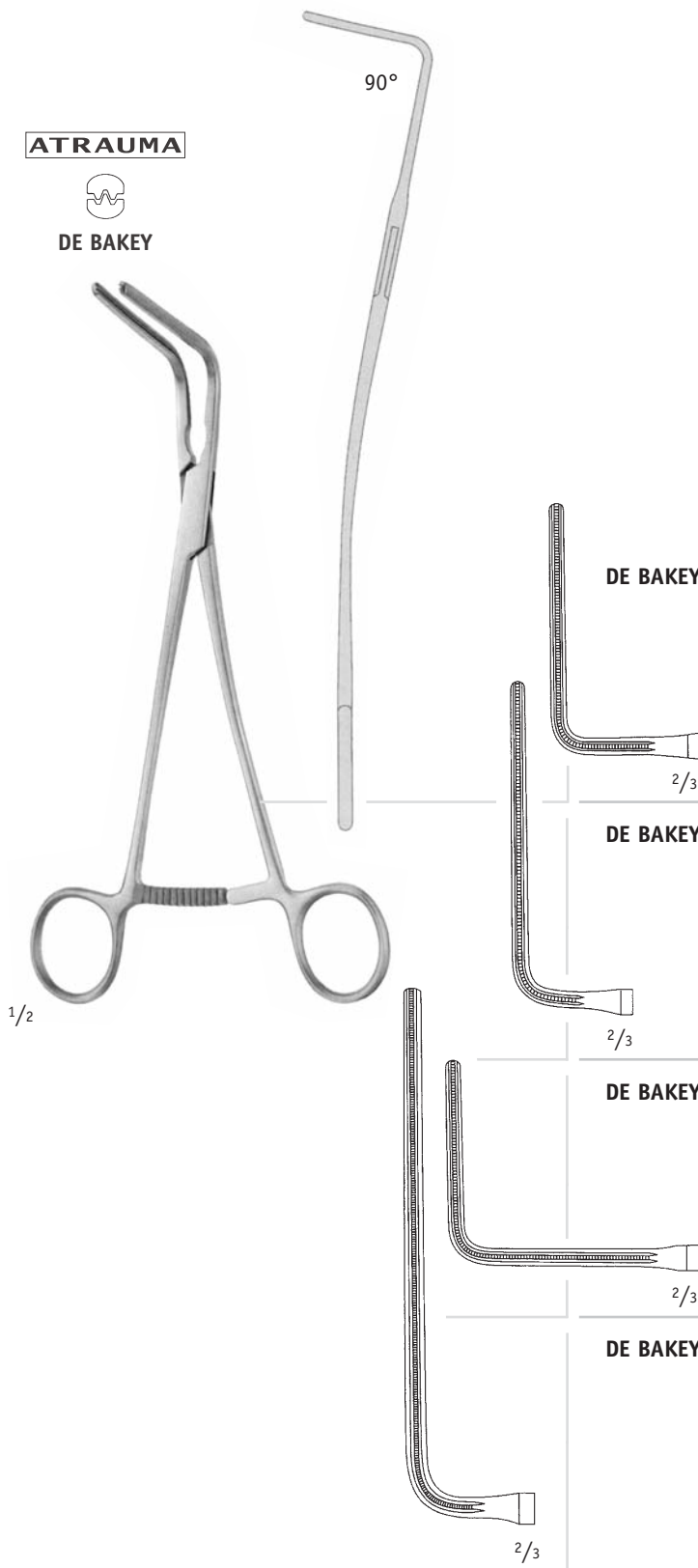
DE BAKEY

 Artikel-Nr.
 Cat. No.

 Gesamtlänge
 Total length

DE BAKEY
06-02-516

 190 mm / 7¹/₂"

 Atraumatische Mehrweckklemme
 Atraumatic Multi-Purpose Clamp
 Pince atraumatique polyvalente
 Pinza clamps atraumática
 Pinze atraumatiche per diversi usi

DE BAKEY
06-02-517

215 mm / 8"

 Atraumatische Mehrweckklemme
 Atraumatic Multi-Purpose Clamp
 Pince atraumatique polyvalente
 Pinza clamps atraumática
 Pinze atraumatiche per diversi usi

DE BAKEY
06-02-515

230 mm / 9"

 Atraumatische Mehrweckklemme
 Atraumatic Multi-Purpose Clamp
 Pince atraumatique polyvalente
 Pinza clamps atraumática
 Pinze atraumatiche per diversi usi

DE BAKEY
06-02-518

 270 mm / 10³/₄"

 Atraumatische Mehrweckklemme
 Atraumatic Multi-Purpose Clamp
 Pince atraumatique polyvalente
 Pinza clamps atraumática
 Pinze atraumatiche per diversi usi

ATRAUMA



DE BAKEY

Artikel-Nr. Cat. No.	Gesamtlänge Total length
06-02-511	205 mm / 8"
Atraumatische Mehrzweckklemme Atraumatic Multi-Purpose Clamp Pince atraumatique polyvalente Pinza clamps atraumática Pinze atraumatiche per diversi usi	
06-02-512T	240 mm / 9½"
Titan · Titanium · Titane · Titanio · Titanio	
06-02-512	240 mm / 9½"
Atraumatische Mehrzweckklemme Atraumatic Multi-Purpose Clamp Pince atraumatique polyvalente Pinza clamps atraumática Pinze atraumatiche per diversi usi	
06-02-510	250 mm / 10"
Atraumatische Mehrzweckklemme Atraumatic Multi-Purpose Clamp Pince atraumatique polyvalente Pinza clamps atraumática Pinze atraumatiche per diversi usi	
06-02-513T	300 mm / 12"
Titan · Titanium · Titane · Titanio · Titanio	
06-02-513	300 mm / 12"
Atraumatische Mehrzweckklemme Atraumatic Multi-Purpose Clamp Pince atraumatique polyvalente Pinza clamps atraumática Pinze atraumatiche per diversi usi	

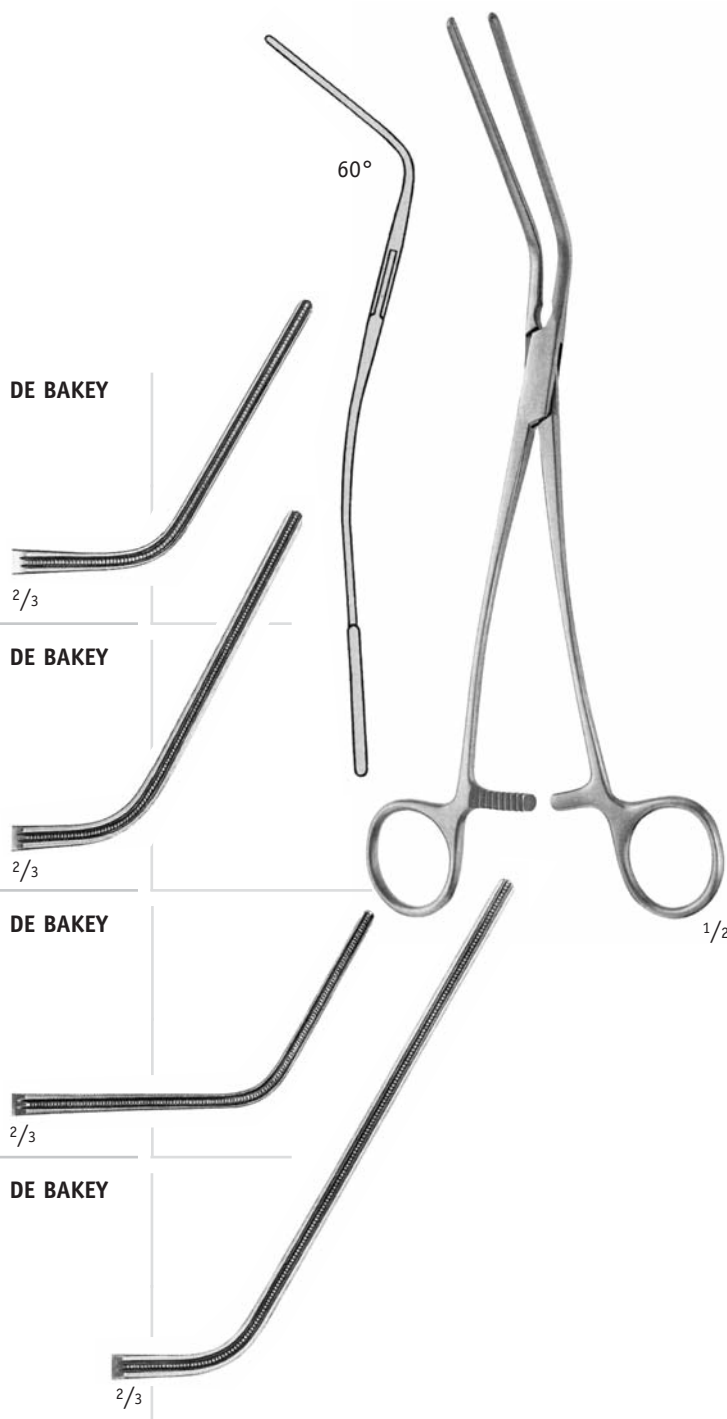

ATRAUMA

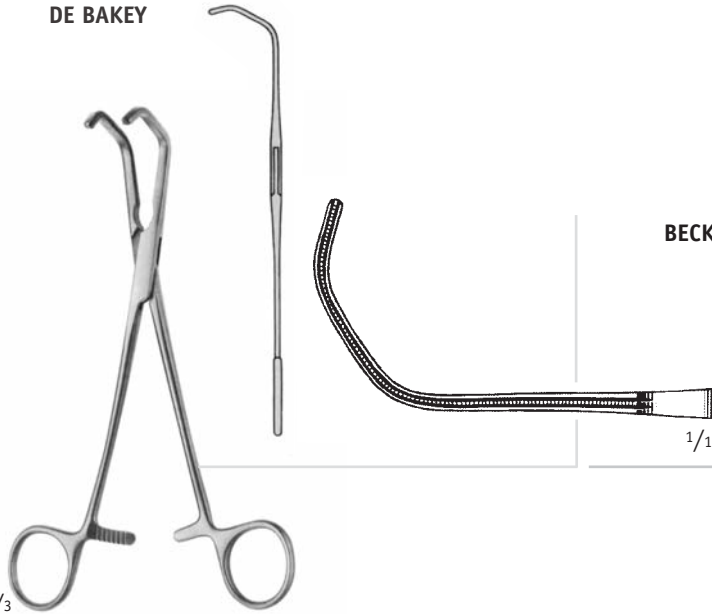
DE BAKEY

1/3

BECK

 Artikel-Nr.
 Cat. No.

 Gesamtlänge
 Total length

06-52-516T

 170 mm / 6³/₄"

Titan · Titanium · Titane · Titanio · Titanio

06-52-516

 170 mm / 6³/₄"

 Atraumatische Mehrzweckklemme
 Atraumatic Multi-Purpose Clamp
 Pince atraumatique polyvalente
 Pinza clamps atraumática
 Pinze atraumatiche per diversi usi

1/1

ATRAUMA

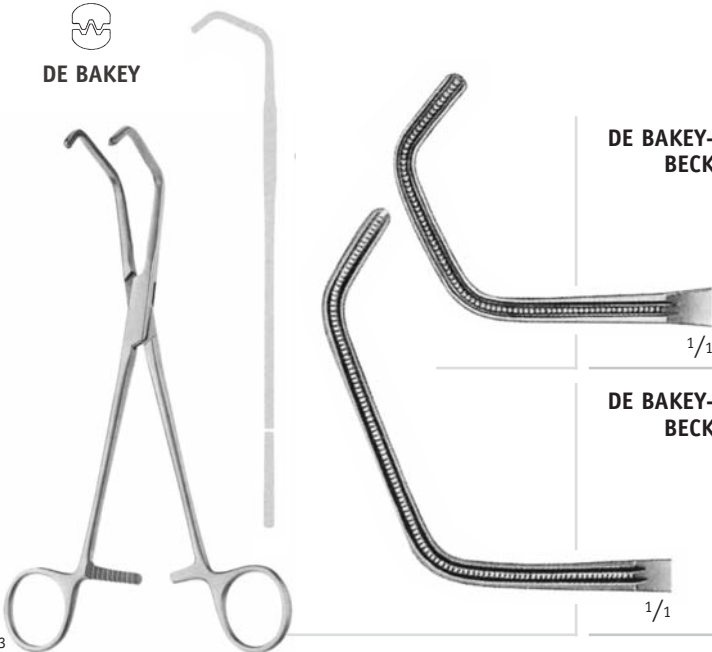
DE BAKEY

1/3

**DE BAKEY-
BECK**
06-02-519

205 mm / 8"

 Atraumatische Mehrzweckklemme, für die Vena Cava
 Atraumatic Multi-Purpose Clamp, for vena cava
 Pince atraumatique polyvalente, pour la vena cava
 Pinza clamps atraumática, de la vena cava
 Pinze atraumatiche per diversi usi, per la vena cava

1/1

**DE BAKEY-
BECK**
06-02-520

 210 mm / 8¹/₄"

 Atraumatische Mehrzweckklemme, für die Vena Cava
 Atraumatic Multi-Purpose Clamp, for vena cava
 Pince atraumatique polyvalente, pour la vena cava
 Pinza clamps atraumática, de la vena cava
 Pinze atraumatiche per diversi usi, per la vena cava

1/1

ATRAUMA



DE BAKEY



2

Artikel-Nr.
Cat. No.

Gesamtlänge
Total length

06-52-517

270 mm / 10¹/₂"

Aortaklemme
Aortic Clamp
Pince pour l'aorte
Pinza clamp para aorta
Pinze per aorta

LIDDLE



1/1

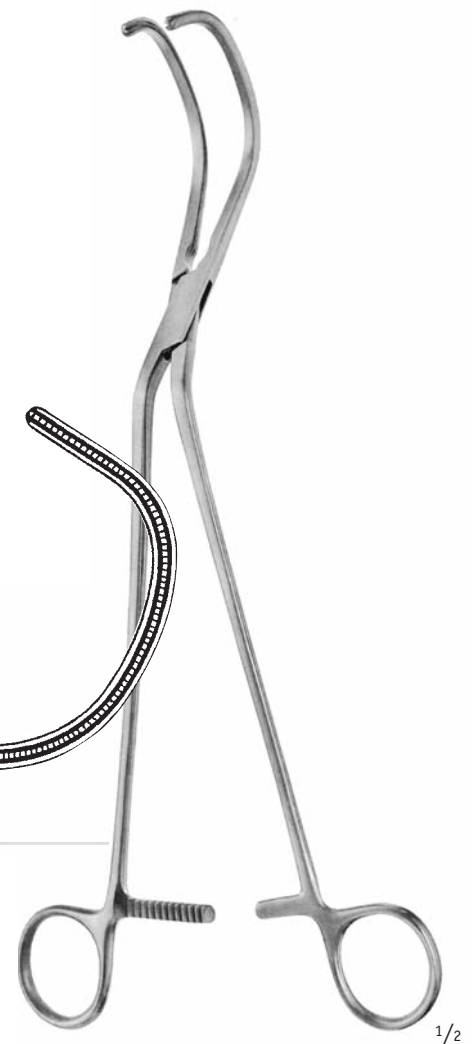

1/2

ATRAUMA

DE BAKEY

1/2

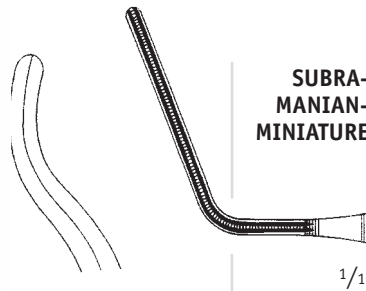
**SUBRA-
MANIAN-
MINIATURE**

1/1

 Artikel-Nr.
 Cat. No.

 Gesamtlänge
 Total length

06-02-578T

155 mm / 6"

Titan · Titanium · Titane · Titanio · Titanio

06-02-578

155 mm / 6"

 Aortaklemme
 Aortic Clamp · Pince pour l'aorte
 Pinza clamp para aorta · Pinze per aorta

ATRAUMA

DE BAKEY

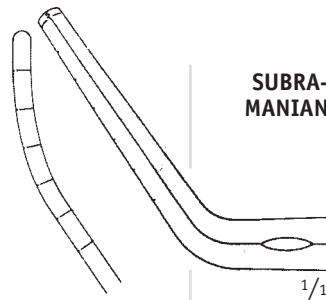

1/2

**SUBRA-
MANIAN**

1/1

06-52-574

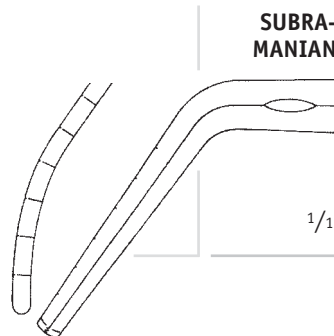
 160 mm / 6¹/₄"

 Aortaklemme, rechts gebogen
 Aortic Clamp, curved to right
 Pince pour l'aorte, courbe à droite
 Pinza clamp para aorta, curva a la derecha
 Pinze per aorta, curva a destra

**SUBRA-
MANIAN**

1/1

06-52-575

 160 mm / 6¹/₄"

 Aortaklemme, links gebogen
 Aortic Clamp, curved to left
 Pince pour l'aorte, courbe à gauche
 Pinza clamp para aorta, curva a la izquierda
 Pinze per aorta, curva a sinistra

ATRAUMA



DE BAKEY

Artikel-Nr.
 Cat. No.

Gesamtlänge
 Total length

06-52-495

230 mm / 6"

Aortaklemme
 Aortic Clamp
 Pince pour l'aorte
 Pinza clamp para aorta
 Pinze per aorta

OCHSNER

1/1

06-02-495

260 mm / 10¹/₄"

Aortaklemme
 Aortic Clamp
 Pince pour l'aorte
 Pinza clamp para aorta
 Pinze per aorta

OCHSNER

1/1



1/3

ATRAUMA



DE BAKEY

06-02-525

210 mm / 8¹/₄"

Aortaklemme
 Aortic Clamp
 Pince pour l'aorte
 Pinza clamp para aorta
 Pinze per aorta

DIETHRICH

1/1



1/3

ATRAUMA

DE BAKEY

1/3

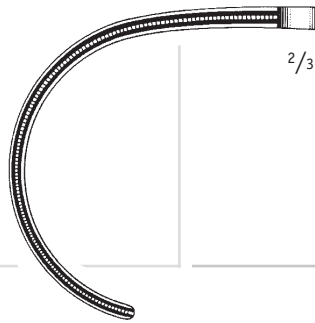
WEBER

2/3

 Artikel-Nr.
 Cat. No.

06-02-488

 Gesamtlänge
 Total length

 260 mm / 10¹/₄"

 Aortaklemme, links gebogen
 Aortic Clamp, curved to left
 Pince pour l'aorte, courbe à gauche
 Pinza clamp para aorta, curva a la izquierda
 Pinze per aorta, curva a sinistra

ATRAUMA

DE BAKEY

1/3

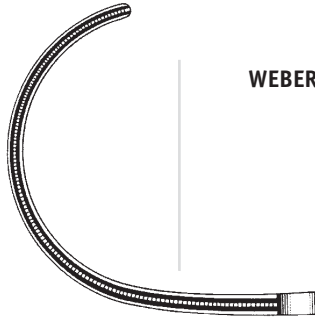
WEBER

2/3

06-02-489

 260 mm / 10¹/₄"

 Aortaklemme, rechts gebogen
 Aortic Clamp, curved to right
 Pince pour l'aorte, courbe à droite
 Pinza clamp para aorta, curva a la derecha
 Pinze per aorta, curva a destra

Artikel-Nr. Cat. No.	Gesamtlänge Total length
06-02-490T	200 mm / 8" Titan · Titanium · Titane · Titanio · Titanio
06-02-490	200 mm / 8" Aorta-Anastomosenklemme Aorta-Anastomosis Clamp Pince à anastomoses d'aorte Pinza clamps para anastomosis de aorta Pinze aortiche
06-02-492T	200 mm / 8" Titan · Titanium · Titane · Titanio · Titanio
06-02-492	200 mm / 8" Aorta-Anastomosenklemme Aorta-Anastomosis Clamp Pince à anastomoses d'aorte Pinza clamps para anastomosis de aorta Pinze aortiche
06-02-491	255 mm / 10" Aorta-Anastomosenklemme Aorta-Anastomosis Clamp Pince à anastomoses d'aorte Pinza clamps para anastomosis de aorta Pinze aortiche

LAMBERT-KAY

2/3

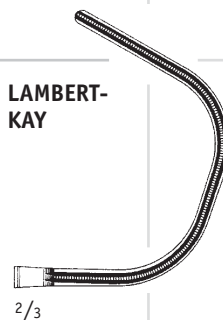

DE BAKEY (LAMBERT modif.)

2/3

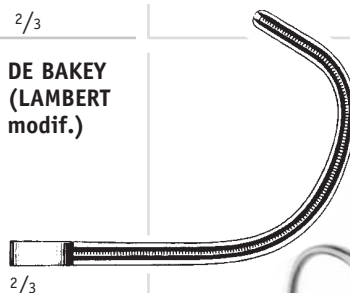

ATRAUMA



DE BAKEY

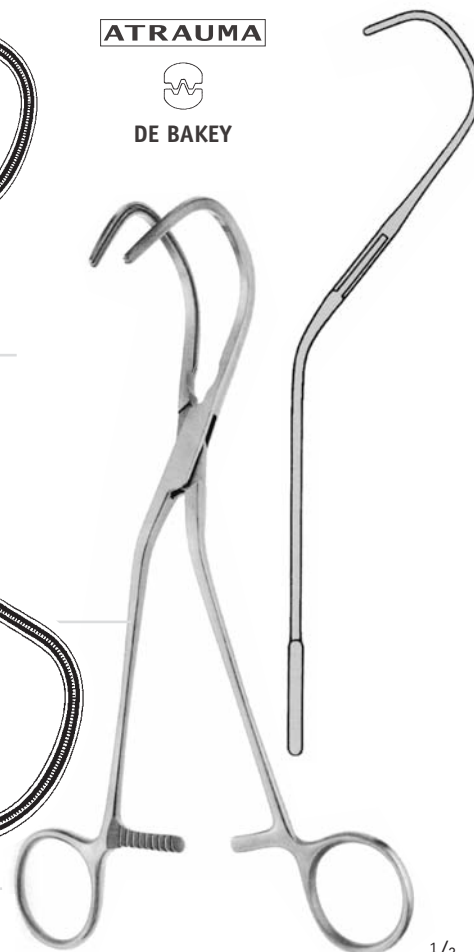

1/2

ATRAUMA



DE BAKEY



1/2

06-02-563

170 mm / 6³/₄"

Aorta-Anastomosenklemme
 Aorta-Anastomosis Clamp
 Pince à anastomoses d'aorte
 Pinza clamps para anastomosis de aorta
 Pinze aortiche

DE BAKEY

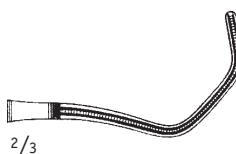

2/3

		Artikel-Nr. Cat. No.	Gesamtlänge Total length
	ATRAUMA		
	DE BAKEY	06-52-468	240 mm / 9 ¹ / ₂ "
		06-52-469	260 mm / 10 ¹ / ₄ "
			Aorta-Aneurysma-Klemme Aorta-Aneurysm Clamp Pince pour anéurisme de l'aorte Pinza clamps para aneurisma de aorta Pinze per aneurisma di aorta
	DE BAKEY	06-02-471	270 mm / 10 ¹ / ₂ "
			Aorta-Aneurysma-Klemme Aorta-Aneurysm Clamp Pince pour anéurisme de l'aorte Pinza clamps para aneurisma de aorta Pinze per aneurisma di aorta
	DE BAKEY	06-02-472	310 mm / 12 ¹ / ₄ "
		06-52-470T	310 mm / 12 ¹ / ₄ "
			Titan · Titanium · Titane · Titanio · Titanio
		06-52-470	310 mm / 12 ¹ / ₄ "
		Aorta-Aneurysma-Klemme Aorta-Aneurysm Clamp Pince pour anéurisme de l'aorte Pinza clamps para aneurisma de aorta Pinze per aneurisma di aorta	
DE BAKEY	06-02-473	330 mm / 13"	
	06-02-480T	330 mm / 13"	
		Titan · Titanium · Titane · Titanio · Titanio	
	06-02-480	330 mm / 13"	
		Aorta-Aneurysma-Klemme Aorta-Aneurysm Clamp Pince pour anéurisme de l'aorte Pinza clamps para aneurisma de aorta Pinze per aneurisma di aorta	
DE BAKEY	06-52-471	350 mm / 13 ³ / ₄ "	
		Aorta-Aneurysma-Klemme Aorta-Aneurysm Clamp Pince pour anéurisme de l'aorte Pinza clamps para aneurisma de aorta Pinze per aneurisma di aorta	

ATRAUMA



DE BAKEY

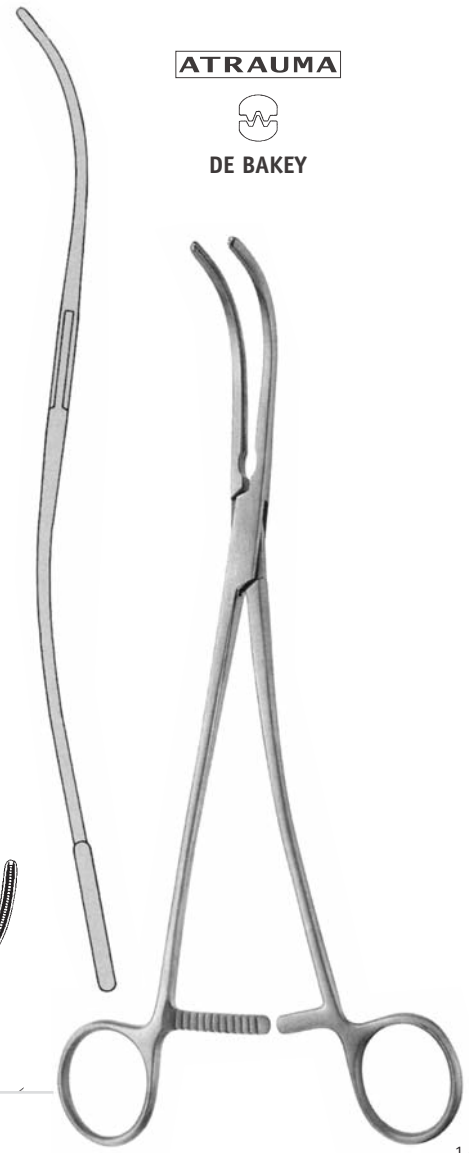

Artikel-Nr.
 Cat. No.

Gesamtlänge
 Total length

06-02-476	245 mm / 9 ¹ / ₂ "
Aorta-Aneurysma-Klemme Aorta-Aneurysm Clamp Pince pour anéurisme de l'aorte Pinza clamps para aneurisma de aorta Pinze per aneurisma di aorta	

DE BAKEY-BAHNSON

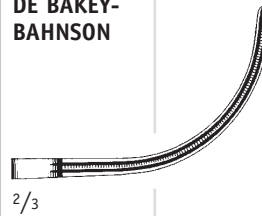

2/3

06-02-477	255 mm / 10"
Aorta-Aneurysma-Klemme Aorta-Aneurysm Clamp Pince pour anéurisme de l'aorte Pinza clamps para aneurisma de aorta Pinze per aneurisma di aorta	

DE BAKEY-BAHNSON



2/3

06-02-478	265 mm / 10 ¹ / ₂ "
Aorta-Aneurysma-Klemme Aorta-Aneurysm Clamp Pince pour anéurisme de l'aorte Pinza clamps para aneurisma de aorta Pinze per aneurisma di aorta	

DE BAKEY-BAHNSON



2/3

1/2

ATRAUMA

DE BAKEY

1/3

DE BAKEY

 Artikel-Nr.
 Cat. No.

06-52-472

 Gesamtlänge
 Total length

280 mm / 11"

 Aorta-Aneurysma-Klemme
 Aorta-Aneurysm Clamp
 Pince pour anéurisme de l'aorte
 Pinza clamps para aneurisma de aorta
 Pinze per aneurisma di aorta

2/3

ATRAUMA

DE BAKEY

1/3

DE BAKEY
06-02-475

280 mm / 11"

 Aorta-Aneurysma-Klemme
 Aorta-Aneurysm Clamp
 Pince pour anéurisme de l'aorte
 Pinza clamps para aneurisma de aorta
 Pinze per aneurisma di aorta

2/3

ATRAUMA



DE BAKEY

Artikel-Nr. Cat. No.	Gesamtlänge Total length
06-52-491	180 mm / 7"
Aorta-Aneurysma-Klemme Aorta-Aneurysm Clamp Pince pour anéurisme de l'aorte Pinza clamps para aneurisma de aorta Pinze per aneurisma di aorta	
06-02-493	200 mm / 8"
Aorta-Aneurysma-Klemme Aorta-Aneurysm Clamp Pince pour anéurisme de l'aorte Pinza clamps para aneurisma de aorta Pinze per aneurisma di aorta	
06-52-492	230 mm / 9"
Aorta-Aneurysma-Klemme Aorta-Aneurysm Clamp Pince pour anéurisme de l'aorte Pinza clamps para aneurisma de aorta Pinze per aneurisma di aorta	
06-02-494	250 mm / 10"
Aorta-Aneurysma-Klemme Aorta-Aneurysm Clamp Pince pour anéurisme de l'aorte Pinza clamps para aneurisma de aorta Pinze per aneurisma di aorta	

DE BAKEY-MORRIS

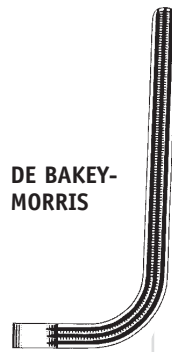

2/3

DE BAKEY-MORRIS

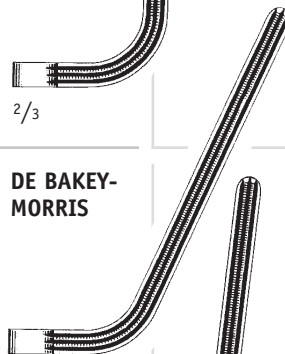

2/3

DE BAKEY-MORRIS



2/3

DE BAKEY-MORRIS

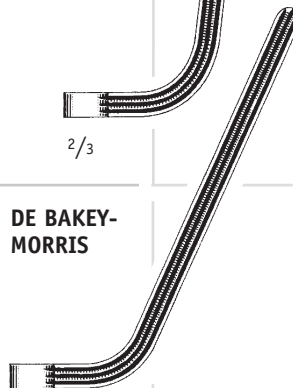

2/3



1/2

ATRAUMA

DE BAKEY

1/3

 Artikel-Nr.
 Cat. No.

 Gesamtlänge
 Total length

**DE BAKEY-
SEMB**
06-02-482

250 mm / 10"

 Aorta-Aneurysma-Klemme
 Aorta-Aneurysm Clamp
 Pince pour anéurisme de l'aorte
 Pinza clamps para aneurisma de aorta
 Pinze per aneurisma di aorta

1/1



1/3

**DE BAKEY-
SEMB**
06-02-481T

 260 mm / 10¹/₄"

Titan · Titanium · Titane · Titanio · Titano

06-02-481

 260 mm / 10¹/₄"

 Aorta-Aneurysma-Klemme
 Aorta-Aneurysm Clamp
 Pince pour anéurisme de l'aorte
 Pinza clamps para aneurisma de aorta
 Pinze per aneurisma di aorta

1/1

ATRAUMA



DE BAKEY

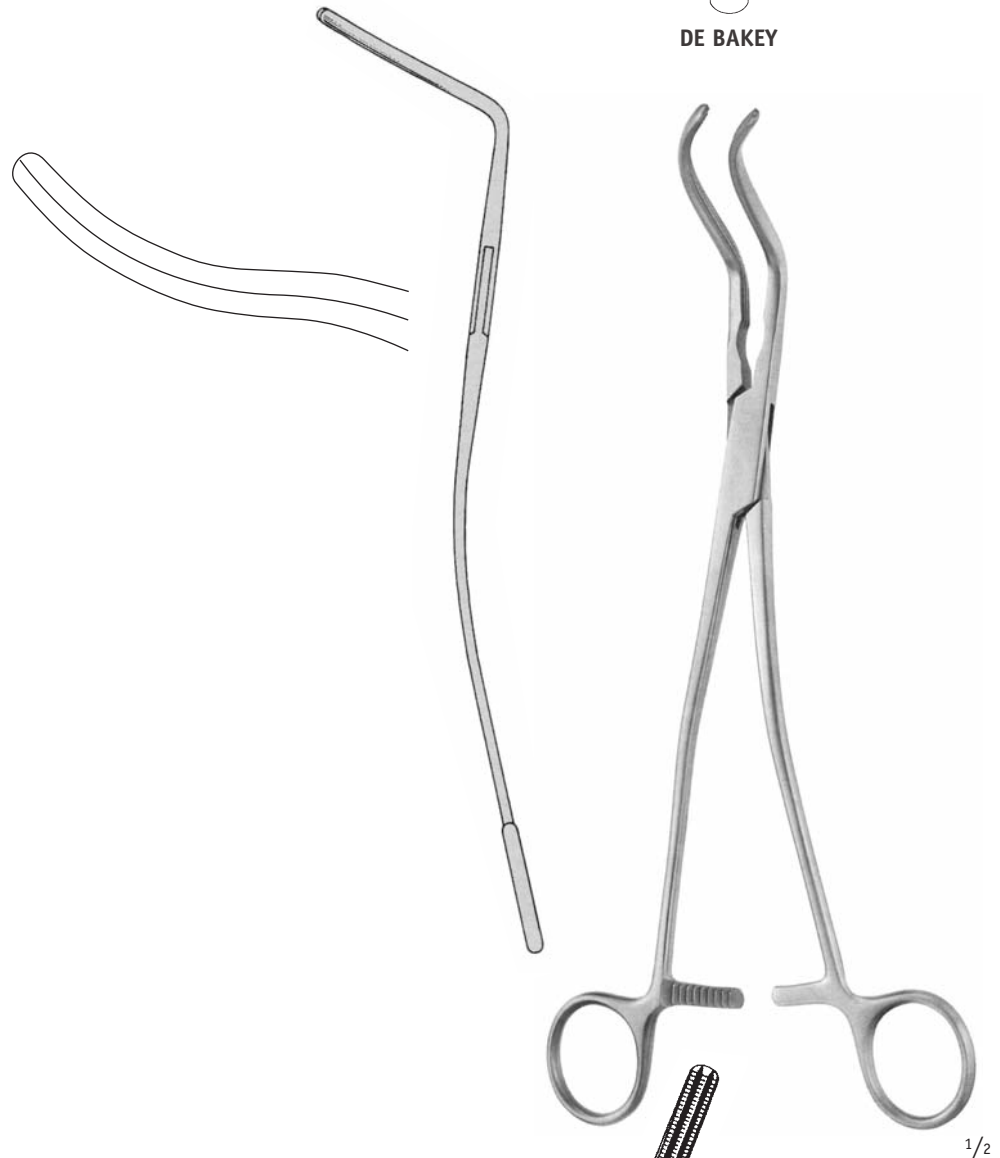

1/2

Artikel-Nr.
 Cat. No.

Gesamtlänge
 Total length

06-02-576

270 mm / 10¹/₂"

Aorta-Aneurysma-Klemme
 Aorta-Aneurysm Clamp
 Pince pour anéurisme de l'aorte
 Pinza clamps para aneurisma de aorta
 Pinze per aneurisma di aorta

DE BAKEY



1/1

ATRAUMA

DE BAKEY

 Artikel-Nr.
 Cat. No.

 Gesamtlänge
 Total length

SATINSKY
06-02-500T

200 mm / 8"

Titan · Titanium · Titane · Titanio · Titanio

06-02-500

200 mm / 8"

 Tangentialklemme
 Tangential Occlusion Clamp
 Pince pour occlusion tangentielle
 Pinza para oclusión tangencial
 Pinze per occlusione tangenziale

SATINSKY
06-02-501T

 240 mm / 9¹/₂"

Titan · Titanium · Titane · Titanio · Titanio

06-02-501

 240 mm / 9¹/₂"

 Tangentialklemme
 Tangential Occlusion Clamp
 Pince pour occlusion tangentielle
 Pinza para oclusión tangencial
 Pinze per occlusione tangenziale

SATINSKY
06-02-502T

250 mm / 10"

Titan · Titanium · Titane · Titanio · Titanio

06-02-502

250 mm / 10"

 Tangentialklemme
 Tangential Occlusion Clamp
 Pince pour occlusion tangentielle
 Pinza para oclusión tangencial
 Pinze per occlusione tangenziale

SATINSKY
06-02-503T

 260 mm / 10¹/₄"

Titan · Titanium · Titane · Titanio · Titanio

06-02-503

 260 mm / 10¹/₄"

 Tangentialklemme
 Tangential Occlusion Clamp
 Pince pour occlusion tangentielle
 Pinza para oclusión tangencial
 Pinze per occlusione tangenziale

SATINSKY
06-02-504T

 270 mm / 10¹/₂"

Titan · Titanium · Titane · Titanio · Titanio

06-02-504

 270 mm / 10¹/₂"

 Tangentialklemme
 Tangential Occlusion Clamp
 Pince pour occlusion tangentielle
 Pinza para oclusión tangencial
 Pinze per occlusione tangenziale

ATRAUMA



DE BAKEY



2

Artikel-Nr. Cat. No.	Gesamtlänge Total length
06-02-506T	230 mm / 9" Titan · Titanium · Titane · Titanio · Titanio
06-02-506	230 mm / 9" Tangentialklemme für die Vena Cava <i>Tangential Occlusion Clamp for vena cava</i> <i>Pince pour occlusion tangentielle pour la vena cava</i> <i>Pinza para oclusión tangencial de la vena cava</i> <i>Pinze per occlusione tangenziale per la vena cava</i>
06-02-507T	240 mm / 9½" Titan · Titanium · Titane · Titanio · Titanio
06-02-507	240 mm / 9½" Tangentialklemme für die Vena Cava <i>Tangential Occlusion Clamp for vena cava</i> <i>Pince pour occlusion tangentielle pour la vena cava</i> <i>Pinza para oclusión tangencial de la vena cava</i> <i>Pinze per occlusione tangenziale per la vena cava</i>
06-02-508T	250 mm / 10" Titan · Titanium · Titane · Titanio · Titanio
06-02-508	250 mm / 10" Tangentialklemme für die Vena Cava <i>Tangential Occlusion Clamp for vena cava</i> <i>Pince pour occlusion tangentielle pour la vena cava</i> <i>Pinza para oclusión tangencial de la vena cava</i> <i>Pinze per occlusione tangenziale per la vena cava</i>

DE BAKEY-SATINSKY



2/3

DE BAKEY-SATINSKY



2/3

DE BAKEY-SATINSKY



2/3



1/2

ATRAUMA

DE BAKEY

1/2

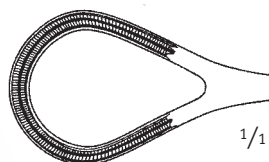

1/1

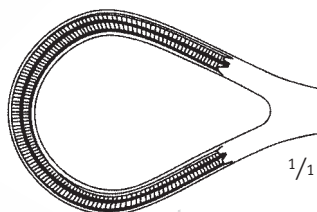

1/1

 Artikel-Nr.
 Cat. No.

 Gesamtlänge
 Total length

05-15-338

250 mm / 10"

 Organfasszange
 Organ grasping forceps
 Pince pour saisir les organes
 Pinza para sacar órganos
 Pinze per afferrare organi

05-15-340

 260 mm / 10¹/₄"

 Organfasszange
 Organ grasping forceps
 Pince pour saisir les organes
 Pinza para sacar órganos
 Pinze per afferrare organi

ATRAUMA



DE BAKEY

Artikel-Nr.
Cat. No.

Gesamtlänge
Total length

06-02-470

200 mm / 8"

DE BAKEY

Iliaca-Klemme
Iliac Clamp
Pince pour veine iliaque
Pinza clamps para iliaca
Pinza per iliaca

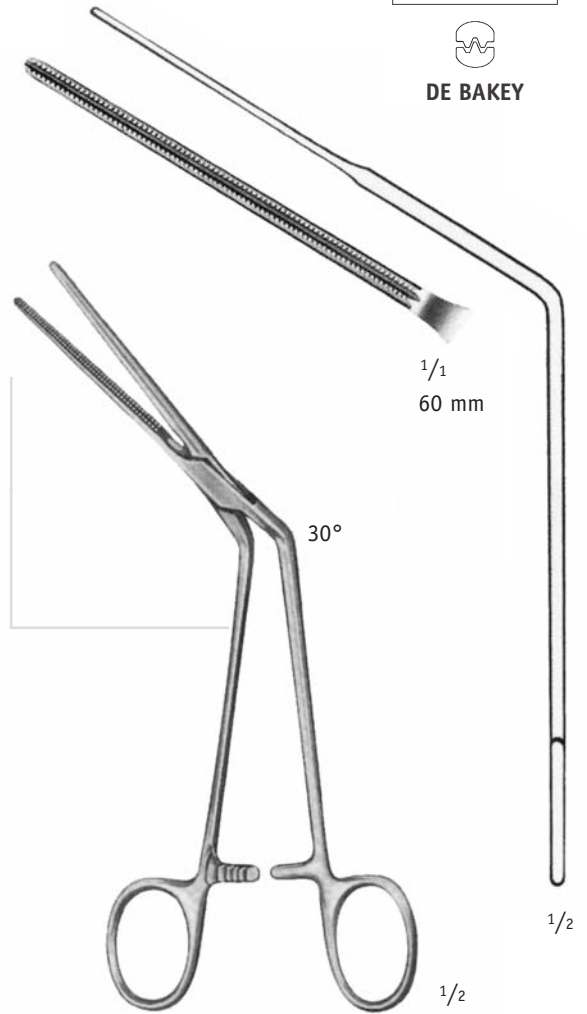

2

ATRAUMA

DE BAKEY

1/3

**DE BAKEY-
RUMEL**
 $\frac{2}{3}$
 81 mm

 Artikel-Nr.
 Cat. No.

06-02-486

 Gesamtlänge
 Total length

250 mm / 10"

 Präparier- und Ligaturklemme
Dissecting and Ligature Clamp
Pince à dissection et à ligature
Pinza de disección y para ligaduras
Pinze per dissezione e per legature

**DE BAKEY-
RUMEL**
 $\frac{2}{3}$
 81 mm

06-02-487

250 mm / 10"

 Präparier- und Ligaturklemme
Dissecting and Ligature Clamp
Pince à dissection et à ligature
Pinza de disección y para ligaduras
Pinze per dissezione e per legature
ATRAUMA

DE BAKEY

1/3

**DE BAKEY-
MC QUIGG-
MIXTER**
 $\frac{2}{3}$
 70 mm

06-02-496

 210 mm / 8 $\frac{1}{4}$ "

 Präparier- und Ligaturklemme
Dissecting and Ligature Clamp
Pince à dissection et à ligature
Pinza de disección y para ligaduras
Pinze per dissezione e per legature

ATRAUMA



DE BAKEY

Artikel-Nr.
 Cat. No.

Gesamtlänge
 Total length

06-02-483

240 mm / 9¹/₂"

Präparier- und Ligaturklemme
Dissecting and Ligature Clamp
Pince à dissection et à ligature
Pinza de disección y para ligaduras
Pinze per dissezione e per legature

DE BAKEY

2/3

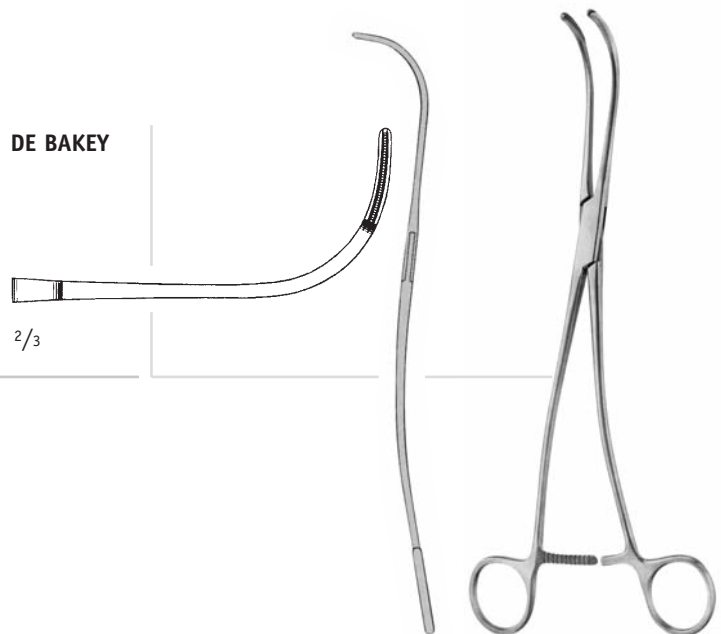

1/3

ATRAUMA



DE BAKEY

06-52-473

240 mm / 9¹/₂"

Präparier- und Ligaturklemme
Dissecting and Ligature Clamp
Pince à dissection et à ligature
Pinza de disección y para ligaduras
Pinze per dissezione e per legature

**DE BAKEY-
 SEMB**

2/3

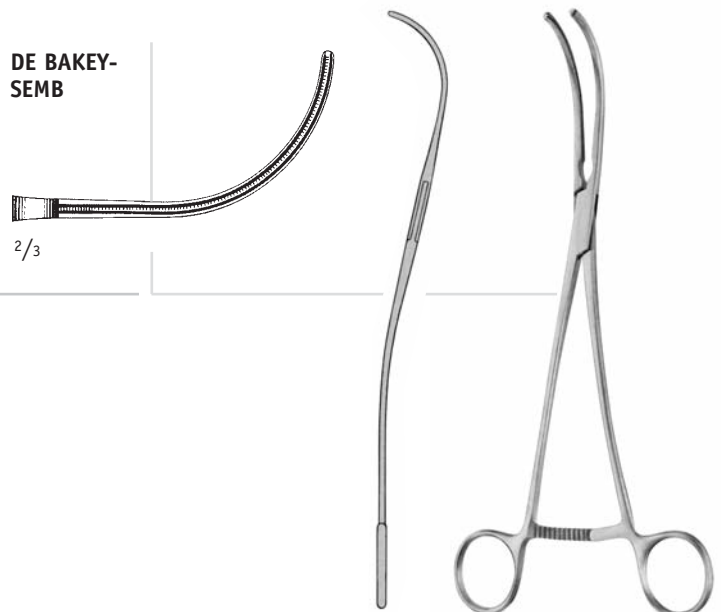

1/3

ATRAUMA

DE BAKEY

 $1/3$

**DE BAKEY-
MIXTER**
 $2/3$
 80 mm

 Artikel-Nr.
 Cat. No.

06-02-497

 Gesamtlänge
 Total length

 285 mm / 11 $1/4$ "

 Präparier- und Ligaturklemme
Dissecting and Ligature Clamp
Pince à dissection et à ligature
Pinza de disección y para ligaduras
Pinze per dissezione e per legature



Artikel-Nr. Cat. No.	Gesamtlänge Total length
06-02-484	190 mm / 7 1/2"
Ligaturklemme Ligature Clamp Pince à ligature Pinza para ligaduras Pinze per legature	
06-02-485	230 mm / 9"
Ligaturklemme Ligature Clamp Pince à ligature Pinza para ligaduras Pinze per legature	

DE BAKEY



2/3

DE BAKEY



2/3

ATRAUMA



DE BAKEY



1/2



2

ATRAUMA

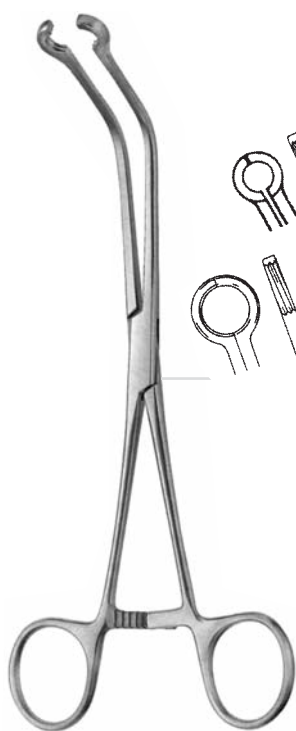
DE BAKEY

1/2

JAVID

1/1

 Artikel-Nr.
 Cat. No.

06-52-475

 Gesamtlänge
 Total length

180 mm / 7"

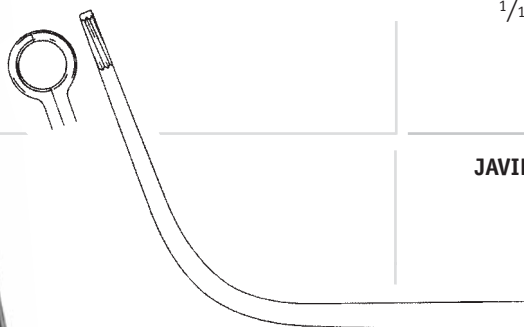
 Carotis-Shuntklemme
 Carotid Shunt Clamp
 Pince pour carotide
 Pinza para carótido
 Pinze carotis

JAVID

1/1

06-52-476

 190 mm / 7¹/₂"

 Carotis-Shuntklemme
 Carotid Shunt Clamp
 Pince pour carotide
 Pinza para carótido
 Pinze carotis

Artikel-Nr.
 Cat. No.

Gesamtlänge
 Total length

06-52-480

140 mm / 5½"

Profunda-Klemme
Profunda Clamp
Pince pour profunda
Pinza clamp para profunda
Pinze per profunda

GREGORY

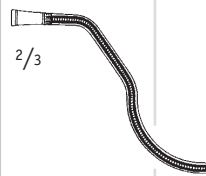

2/3

ATRAUMA



DE BAKEY

06-52-481

160 mm / 6¼"

Profunda-Klemme
Profunda Clamp
Pince pour profunda
Pinza clamp para profunda
Pinze per profunda

GREGORY

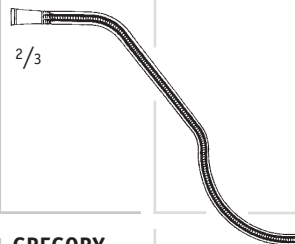

2/3

06-52-482

180 mm / 7"

Profunda-Klemme
Profunda Clamp
Pince pour profunda
Pinza clamp para profunda
Pinze per profunda

GREGORY

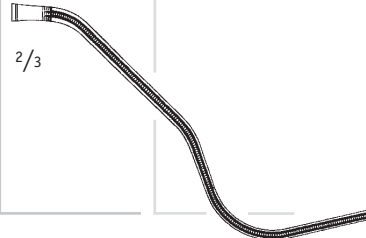

2/3



1/2

ATRAUMA

DE BAKEY

 $1/2$

CASTAÑEDA
 $1/1$
 30°

 Artikel-Nr.
 Cat. No.

06-02-581

 Gesamtlänge
 Total length

 120 mm / $4\frac{3}{4}$ "

Neonatal- und Pädiatrie-Klemme, extra feines Modell
 Neonatal and Pediatric Clamp, extra delicate pattern
 Pince pour des nouveaux-nés et des enfants, modèle très fin
 Pinza clamp para recién nacidos y niños, modelo muy fino
 Pinza pediatrica per neonate e bambini, modelli molto fini

CASTAÑEDA
 $1/1$
 45°
06-02-582

 120 mm / $4\frac{3}{4}$ "

Neonatal- und Pädiatrie-Klemme, extra feines Modell
 Neonatal and Pediatric Clamp, extra delicate pattern
 Pince pour des nouveaux-nés et des enfants, modèle très fin
 Pinza clamp para recién nacidos y niños, modelo muy fino
 Pinza pediatrica per neonate e bambini, modelli molto fini

ATRAUMA



DE BAKEY



2

Artikel-Nr.
 Cat. No.

Gesamtlänge
 Total length

<p>06-02-590</p>	<p>155 mm / 6"</p> <p>Neonatal- und Pädiatrie-Klemme, extra feines Modell <i>Neonatal and Pediatric Clamp, extra delicate pattern</i> <i>Pince pour des nouveaux-nés et des enfants, modèle très fin</i> <i>Pinza clamp para recién nacidos y niños, modelo muy fino</i> <i>Pinza pediatrica per neonate e bambini, modelli molto fini</i></p>
<p>06-02-591</p>	<p>155 mm / 6"</p> <p>Neonatal- und Pädiatrie-Klemme, extra feines Modell <i>Neonatal and Pediatric Clamp, extra delicate pattern</i> <i>Pince pour des nouveaux-nés et des enfants, modèle très fin</i> <i>Pinza clamp para recién nacidos y niños, modelo muy fino</i> <i>Pinza pediatrica per neonate e bambini, modelli molto fini</i></p>
<p>06-02-592</p>	<p>155 mm / 6"</p> <p>Neonatal- und Pädiatrie-Klemme, extra feines Modell <i>Neonatal and Pediatric Clamp, extra delicate pattern</i> <i>Pince pour des nouveaux-nés et des enfants, modèle très fin</i> <i>Pinza clamp para recién nacidos y niños, modelo muy fino</i> <i>Pinza pediatrica per neonate e bambini, modelli molto fini</i></p>
<p>06-02-593</p>	<p>155 mm / 6"</p> <p>Neonatal- und Pädiatrie-Klemme, extra feines Modell <i>Neonatal and Pediatric Clamp, extra delicate pattern</i> <i>Pince pour des nouveaux-nés et des enfants, modèle très fin</i> <i>Pinza clamp para recién nacidos y niños, modelo muy fino</i> <i>Pinza pediatrica per neonate e bambini, modelli molto fini</i></p>

CASTAÑEDA



1/1

CASTAÑEDA



1/1

CASTAÑEDA



1/1

CASTAÑEDA



1/1

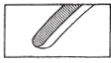

1/2

ATRAUMA

CASTAÑEDA

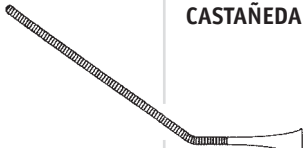
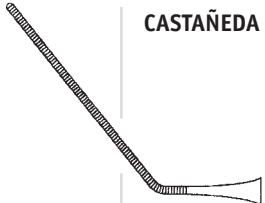
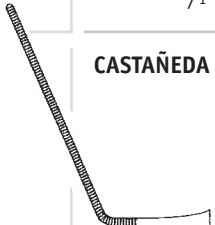
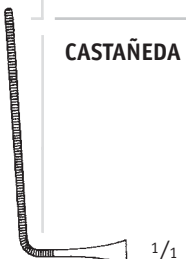
2/3

	Artikel-Nr. Cat. No.	Gesamtlänge Total length
 CASTAÑEDA 1/1	06-52-530	130 mm / 5" Neonatal- und Pädiatrie-Klemme, extra feines Modell <i>Neonatal and Pediatric Clamp, extra delicate pattern</i> <i>Pince pour des nouveaux-nés et des enfants, modèle très fin</i> <i>Pinza clamp para recién nacidos y niños, modelo muy fino</i> <i>Pinza pediatrica per neonate e bambini, modelli molto fini</i>
 CASTAÑEDA 1/1	06-52-531	125 mm / 5" Neonatal- und Pädiatrie-Klemme, extra feines Modell <i>Neonatal and Pediatric Clamp, extra delicate pattern</i> <i>Pince pour des nouveaux-nés et des enfants, modèle très fin</i> <i>Pinza clamp para recién nacidos y niños, modelo muy fino</i> <i>Pinza pediatrica per neonate e bambini, modelli molto fini</i>
 CASTAÑEDA 1/1	06-52-532	115 mm / 4 ¹ / ₂ " Neonatal- und Pädiatrie-Klemme, extra feines Modell <i>Neonatal and Pediatric Clamp, extra delicate pattern</i> <i>Pince pour des nouveaux-nés et des enfants, modèle très fin</i> <i>Pinza clamp para recién nacidos y niños, modelo muy fino</i> <i>Pinza pediatrica per neonate e bambini, modelli molto fini</i>
 CASTAÑEDA 1/1	06-52-533	115 mm / 4 ¹ / ₂ " Neonatal- und Pädiatrie-Klemme, extra feines Modell <i>Neonatal and Pediatric Clamp, extra delicate pattern</i> <i>Pince pour des nouveaux-nés et des enfants, modèle très fin</i> <i>Pinza clamp para recién nacidos y niños, modelo muy fino</i> <i>Pinza pediatrica per neonate e bambini, modelli molto fini</i>
 CASTAÑEDA 1/1	06-52-534	110 mm / 4 ¹ / ₄ " Neonatal- und Pädiatrie-Klemme, extra feines Modell <i>Neonatal and Pediatric Clamp, extra delicate pattern</i> <i>Pince pour des nouveaux-nés et des enfants, modèle très fin</i> <i>Pinza clamp para recién nacidos y niños, modelo muy fino</i> <i>Pinza pediatrica per neonate e bambini, modelli molto fini</i>

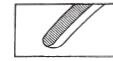
ATRAUMA



CASTAÑEDA



2

Artikel-Nr. Cat. No.	Gesamtlänge Total length	
06-52-535	115 mm / 4 ¹ / ₂ "	<p>Neonatal- und Pädiatrie-Klemme, extra feines Modell Neonatal and Pediatric Clamp, extra delicate pattern Pince pour des nouveaux-nés et des enfants, modèle très fin Pinza clamp para recién nacidos y niños, modelo muy fino Pinza pediátrica per neonate e bambini, modelli molto fini</p>
06-52-536	120 mm / 4 ³ / ₄ "	<p>Neonatal- und Pädiatrie-Klemme, extra feines Modell Neonatal and Pediatric Clamp, extra delicate pattern Pince pour des nouveaux-nés et des enfants, modèle très fin Pinza clamp para recién nacidos y niños, modelo muy fino Pinza pediátrica per neonate e bambini, modelli molto fini</p>
06-52-537	120 mm / 4 ³ / ₄ "	<p>Neonatal- und Pädiatrie-Klemme, extra feines Modell Neonatal and Pediatric Clamp, extra delicate pattern Pince pour des nouveaux-nés et des enfants, modèle très fin Pinza clamp para recién nacidos y niños, modelo muy fino Pinza pediátrica per neonate e bambini, modelli molto fini</p>
06-52-538	120 mm / 4 ³ / ₄ "	<p>Neonatal- und Pädiatrie-Klemme, extra feines Modell Neonatal and Pediatric Clamp, extra delicate pattern Pince pour des nouveaux-nés et des enfants, modèle très fin Pinza clamp para recién nacidos y niños, modelo muy fino Pinza pediátrica per neonate e bambini, modelli molto fini</p>

CASTAÑEDA

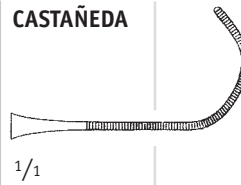

1/1

CASTAÑEDA

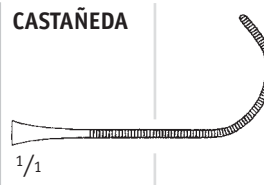

1/1

CASTAÑEDA

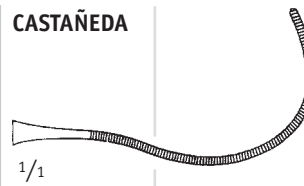

1/1

CASTAÑEDA

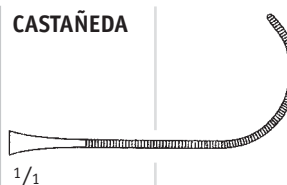

1/1



2/3

ATRAUMA

COOLEY

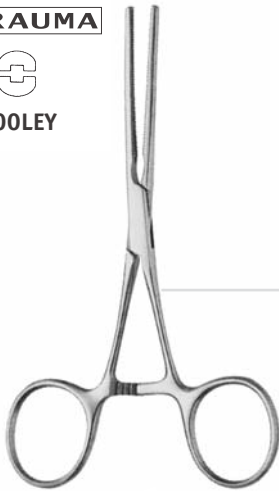

1/2



COOLEY

1/1

 Artikel-Nr.
 Cat. No.

06-02-700

 Gesamtlänge
 Total length

125 mm / 5"

 Bulldogklemme mit Ringgriff
 Ring Bulldog clamp
 Clamp Bulldog, manche à anneau
 Clamp Bulldog con mango de anillo
 Pinze Bulldog con manico di anello
ATRAUMA

COOLEY



15°

1/2

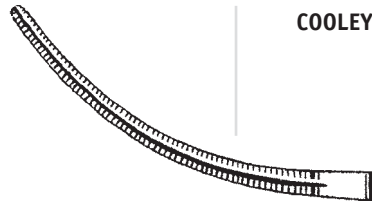

COOLEY

1/1

06-02-702

125 mm / 5"

 Bulldogklemme mit Ringgriff
 Ring Bulldog clamp
 Clamp Bulldog, manche à anneau
 Clamp Bulldog con mango de anillo
 Pinze Bulldog con manico di anello

COOLEY

1/1

06-02-701

135 mm / 5 1/4"

 Bulldogklemme mit Ringgriff
 Ring Bulldog clamp
 Clamp Bulldog, manche à anneau
 Clamp Bulldog con mango de anillo
 Pinze Bulldog con manico di anello
ATRAUMA

COOLEY



1/2



COOLEY

1/1

06-02-707

105 mm / 4 1/4"

 Bulldogklemme mit Ringgriff
 Ring Bulldog clamp
 Clamp Bulldog, manche à anneau
 Clamp Bulldog con mango de anillo
 Pinze Bulldog con manico di anello

ATRAUMA



COOLEY

Artikel-Nr.
 Cat. No.

Gesamtlänge
 Total length

06-02-703

130 mm / 5"

Bulldogklemme mit Ringgriff
 Ring Bulldog clamp
 Clamp Bulldog, manche à anneau
 Clamp Bulldog con mango de anillo
 Pinze Bulldog con manico di anello

COOLEY

1/1

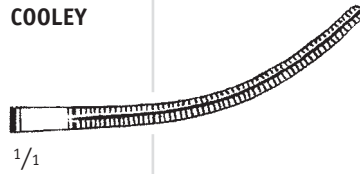

1/2

06-02-704

125 mm / 5"

Bulldogklemme mit Ringgriff
 Ring Bulldog clamp
 Clamp Bulldog, manche à anneau
 Clamp Bulldog con mango de anillo
 Pinze Bulldog con manico di anello

COOLEY

1/1

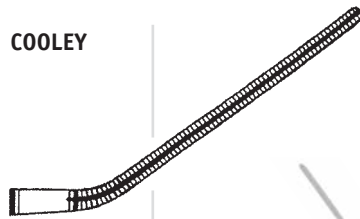

1/2

ATRAUMA

COOLEY

1/2

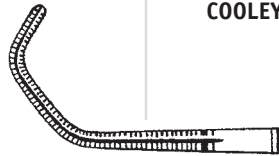
COOLEY

1/1

 Artikel-Nr.
 Cat. No.

06-02-708

 Gesamtlänge
 Total length

 120 mm / 4³/₄"

 Bulldogklemme mit Ringgriff
 Ring Bulldog clamp
 Clamp Bulldog, manche à anneau
 Clamp Bulldog con mango de anillo
 Pinze Bulldog con manico di anello

ATRAUMA

COOLEY

1/2







COOLEY

1/1

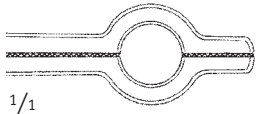
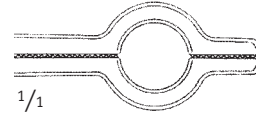
06-02-706

 135 mm / 5¹/₄"

 Bulldogklemme mit Ringgriff
 Ring Bulldog clamp
 Clamp Bulldog, manche à anneau
 Clamp Bulldog con mango de anillo
 Pinze Bulldog con manico di anello

Artikel-Nr. Cat. No.	Gesamtlänge Total length		
06-52-540	160 mm / 6 ¹ / ₄ " 24 Charr. Katheterklemme für die Vena Cava <i>Catheter clamp for vena cava</i> <i>Pince pour catheters pour la vena cava</i> <i>Pinza para catéteres para la vena cava</i> <i>Pinze per cateteri per la vena cava</i>	COOLEY	 <p>1/1</p>
06-52-541	160 mm / 6 ¹ / ₄ " 26 Charr. Katheterklemme für die Vena Cava <i>Catheter clamp for vena cava</i> <i>Pince pour catheters pour la vena cava</i> <i>Pinza para catéteres para la vena cava</i> <i>Pinze per cateteri per la vena cava</i>	COOLEY	 <p>1/1</p>
06-52-542	200 mm / 8" 28 Charr. Katheterklemme für die Vena Cava <i>Catheter clamp for vena cava</i> <i>Pince pour catheters pour la vena cava</i> <i>Pinza para catéteres para la vena cava</i> <i>Pinze per cateteri per la vena cava</i>	COOLEY	 <p>1/1</p>
06-52-543	200 mm / 8" 30 Charr. Katheterklemme für die Vena Cava <i>Catheter clamp for vena cava</i> <i>Pince pour catheters pour la vena cava</i> <i>Pinza para catéteres para la vena cava</i> <i>Pinze per cateteri per la vena cava</i>	COOLEY	 <p>1/1</p>
06-52-544	200 mm / 8" 32 Charr. Katheterklemme für die Vena Cava <i>Catheter clamp for vena cava</i> <i>Pince pour catheters pour la vena cava</i> <i>Pinza para catéteres para la vena cava</i> <i>Pinze per cateteri per la vena cava</i>	COOLEY	 <p>1/1</p>
06-52-545	200 mm / 8" 36 Charr. Katheterklemme für die Vena Cava <i>Catheter clamp for vena cava</i> <i>Pince pour catheters pour la vena cava</i> <i>Pinza para catéteres para la vena cava</i> <i>Pinze per cateteri per la vena cava</i>	COOLEY	 <p>1/1</p>

ATRAUMA



COOLEY



2

ATRAUMA

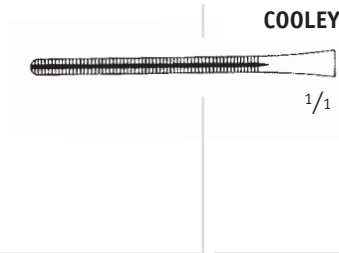
COOLEY

 Artikel-Nr.
 Cat. No.

 Gesamtlänge
 Total length

06-52-740

140 mm / 5 1/2"

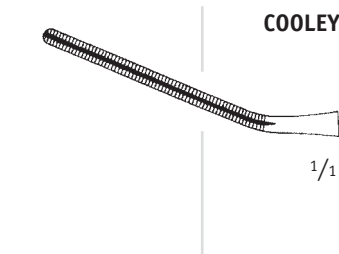
Neonatal- und Pädiatrie-Klemme, extra feines Modell
Neonatal and Pediatric Clamp, extra delicate pattern
Pince pour des nouveaux-nés et des enfants, modèle très fin
Pinza clamp para recién nacidos y niños, modelo muy fino
Pinza pediatrica per neonate e bambini, modelli molto fini

COOLEY
06-02-741

140 mm / 5 1/2"

Neonatal- und Pädiatrie-Klemme, extra feines Modell
Neonatal and Pediatric Clamp, extra delicate pattern
Pince pour des nouveaux-nés et des enfants, modèle très fin
Pinza clamp para recién nacidos y niños, modelo muy fino
Pinza pediatrica per neonate e bambini, modelli molto fini

ATRAUMA

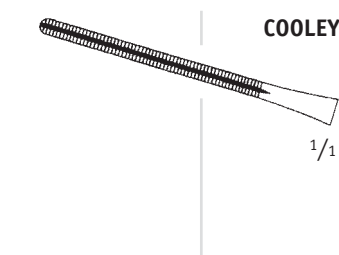
COOLEY

COOLEY
06-02-742

140 mm / 5 1/2"

Neonatal- und Pädiatrie-Klemme, extra feines Modell
Neonatal and Pediatric Clamp, extra delicate pattern
Pince pour des nouveaux-nés et des enfants, modèle très fin
Pinza clamp para recién nacidos y niños, modelo muy fino
Pinza pediatrica per neonate e bambini, modelli molto fini

ATRAUMA



COOLEY

Artikel-Nr.
 Cat. No.

Gesamtlänge
 Total length

06-52-741

140 mm / 5 1/2"

Neonatal- und Pädiatrie-Klemme, extra feines Modell
 Neonatal and Pediatric Clamp, extra delicate pattern
 Pince pour des nouveaux-nés et des enfants, modèle très fin
 Pinza clamp para recién nacidos y niños, modelo muy fino
 Pinza pediatrica per neonate e bambini, modelli molto fini

COOLEY
YASARGIL



1/1

1/1



1/2

ATRAUMA



COOLEY

06-02-743

140 mm / 5 1/2"

Neonatal- und Pädiatrie-Klemme, extra feines Modell
 Neonatal and Pediatric Clamp, extra delicate pattern
 Pince pour des nouveaux-nés et des enfants, modèle très fin
 Pinza clamp para recién nacidos y niños, modelo muy fino
 Pinza pediatrica per neonate e bambini, modelli molto fini

COOLEY



1/1



1/2

ATRAUMA



COOLEY

06-52-742

140 mm / 5 1/2"

Neonatal- und Pädiatrie-Klemme
 Neonatal and Pediatric Clamp
 Pince pour des nouveaux-nés et des enfants
 Pinza clamp para recién nacidos y niños
 Pinza pediatrica per neonate e bambini

COOLEY

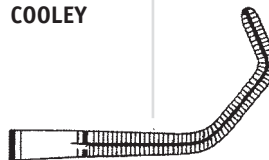

1/1

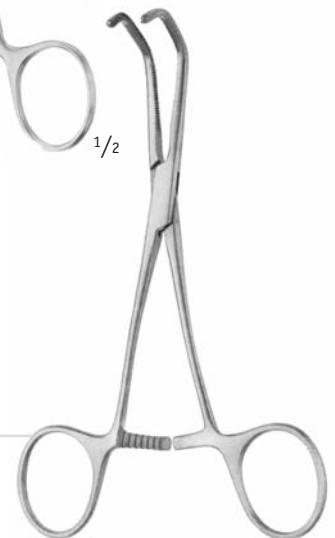

1/2



2

ATRAUMA

COOLEY



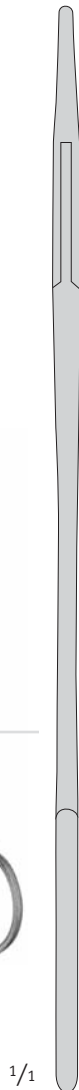





1/2



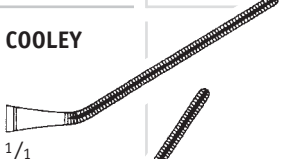
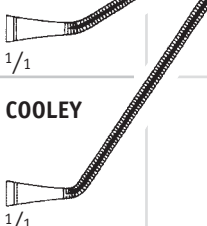

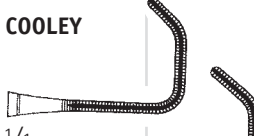
1/1

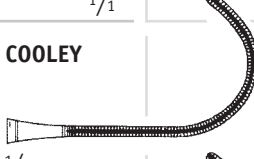
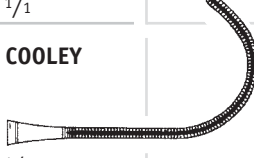
	Artikel-Nr. Cat. No.	Gesamtlänge Total length
 COOLEY 1/1	06-52-600	145 mm / 5 ³ / ₄ " Fig. 1
 COOLEY 1/1	06-52-601	145 mm / 5 ³ / ₄ " Fig. 2
 COOLEY 1/1	06-52-602	145 mm / 5 ³ / ₄ " Fig. 3
 COOLEY 1/1	06-52-603	135 mm / 5 ¹ / ₄ " Fig. 4
 COOLEY 1/1	06-52-604	140 mm / 5 ¹ / ₂ " Fig. 5
 COOLEY 1/1	06-52-605	135 mm / 5 ¹ / ₄ " Fig. 6
 COOLEY 1/1	06-52-606	135 mm / 5 ¹ / ₄ " Fig. 7
 COOLEY 1/1	06-52-607	140 mm / 5 ¹ / ₂ " Fig. 8
 COOLEY 1/1	06-52-608	135 mm / 5 ¹ / ₄ " Fig. 9

Neonatal- und Pädiatrie-Klemmen, extra feine Modelle
Neonatal and Pediatric Clamps, extra delicate patterns
Pincas pour des nouveaux-nés et des enfants, modèles très fins
Pinza clamps para recién nacidos y niños, modelos muy finos
Pinze pediatriche per neonate e bambini, modelli molto fini

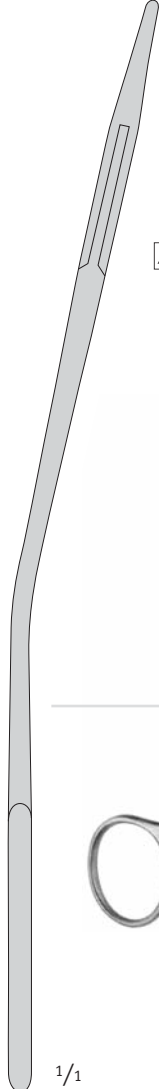
Artikel-Nr. Cat. No.	Gesamtlänge Total length		
06-52-610	145 mm / 5 ³ / ₄ " Fig. 1	COOLEY	 1/1
06-52-611	145 mm / 5 ³ / ₄ " Fig. 2	COOLEY	 1/1
06-52-612	145 mm / 5 ³ / ₄ " Fig. 3	COOLEY	 1/1
06-52-613	135 mm / 5 ¹ / ₄ " Fig. 4	COOLEY	 1/1
06-52-614	140 mm / 5 ¹ / ₂ " Fig. 5	COOLEY	 1/1
06-52-615	135 mm / 5 ¹ / ₄ " Fig. 6	COOLEY	 1/1
06-52-616	135 mm / 5 ¹ / ₄ " Fig. 7	COOLEY	 1/1
06-52-617	140 mm / 5 ¹ / ₂ " Fig. 8	COOLEY	 1/1
06-52-618	135 mm / 5 ¹ / ₄ " Fig. 9	COOLEY	 1/1

 1/1
 1/2





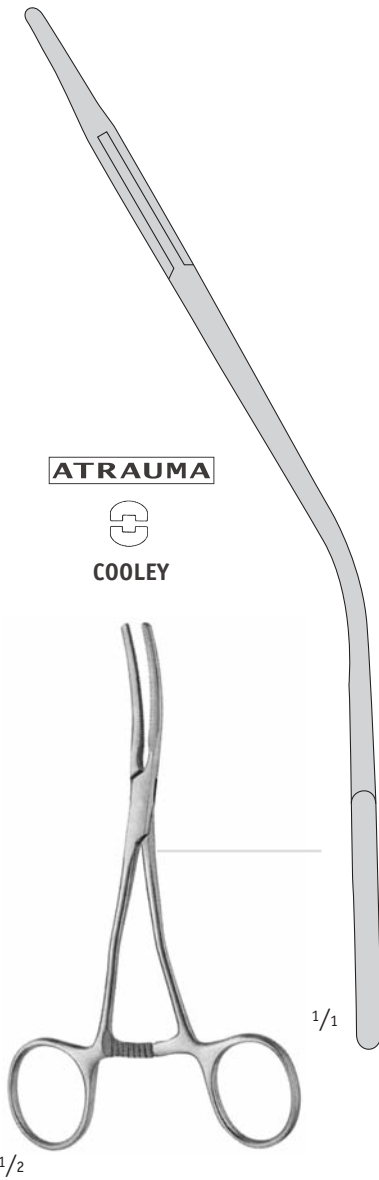



ATRAUMA

COOLEY

Neonatal- und Pädiatrie-Klemmen, extra feine Modelle
Neonatal and Pediatric Clamps, extra delicate patterns
Pincas pour des nouveaux-nés et des enfants, modèles très fins
Pinza clamps para recién nacidos y niños, modelos muy finos
Pinze pediatriche per neonate e bambini, modelli molto fini



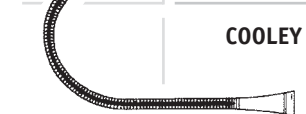







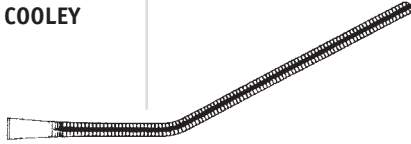

1/2

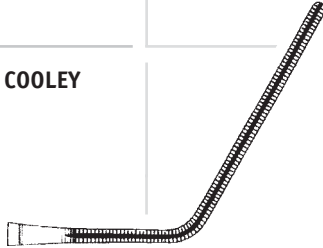
1/1

	Artikel-Nr. Cat. No.	Gesamtlänge Total length
 COOLEY 1/1	06-52-620	140 mm / 5 ¹ / ₂ " Fig. 1
 COOLEY 1/1	06-52-621	140 mm / 5 ¹ / ₂ " Fig. 2
 COOLEY 1/1	06-52-622	140 mm / 5 ¹ / ₂ " Fig. 3
 COOLEY 1/1	06-52-623	130 mm / 5" Fig. 4
 COOLEY 1/1	06-52-624	140 mm / 5 ¹ / ₂ " Fig. 5
 COOLEY 1/1	06-52-625	130 mm / 5" Fig. 6
 COOLEY 1/1	06-52-626	130 mm / 5" Fig. 7
 COOLEY 1/1	06-52-627	140 mm / 5 ¹ / ₂ " Fig. 8
 COOLEY 1/1	06-52-628	135 mm / 5 ¹ / ₄ " Fig. 9

Neonatal- und Pädiatrie-Klemmen, extra feine Modelle
Neonatal and Pediatric Clamps, extra delicate patterns
Pincas pour des nouveaux-nés et des enfants, modèles très fins
Pinza clamps para recién nacidos y niños, modelos muy finos
Pinze pediatriche per neonate e bambini, modelli molto fini

Artikel-Nr. Cat. No.	Gesamtlänge Total length	ATRAUMA	
06-52-630	165 mm / 6 ¹ / ₂ " Neonatal- und Pädiatrie-Klemme, extra feines Modell <i>Neonatal and Pediatric Clamp, extra delicate pattern</i> <i>Pince pour des nouveaux-nés et des enfants, modèle très fin</i> <i>Pinza clamp para recién nacidos y niños, modelo muy fino</i> <i>Pinza pediátrica per neonate e bambini, modelli molto fini</i>	COOLEY  1/1	 COOLEY  1/2
06-52-631	160 mm / 6 ¹ / ₄ " Neonatal- und Pädiatrie-Klemme, extra feines Modell <i>Neonatal and Pediatric Clamp, extra delicate pattern</i> <i>Pince pour des nouveaux-nés et des enfants, modèle très fin</i> <i>Pinza clamp para recién nacidos y niños, modelo muy fino</i> <i>Pinza pediátrica per neonate e bambini, modelli molto fini</i>	COOLEY  1/1	 1/2
06-52-632	155 mm / 6" Neonatal- und Pädiatrie-Klemme, extra feines Modell <i>Neonatal and Pediatric Clamp, extra delicate pattern</i> <i>Pince pour des nouveaux-nés et des enfants, modèle très fin</i> <i>Pinza clamp para recién nacidos y niños, modelo muy fino</i> <i>Pinza pediátrica per neonate e bambini, modelli molto fini</i>	COOLEY  1/1	 1/2
06-52-633	155 mm / 6" Neonatal- und Pädiatrie-Klemme, extra feines Modell <i>Neonatal and Pediatric Clamp, extra delicate pattern</i> <i>Pince pour des nouveaux-nés et des enfants, modèle très fin</i> <i>Pinza clamp para recién nacidos y niños, modelo muy fino</i> <i>Pinza pediátrica per neonate e bambini, modelli molto fini</i>	COOLEY  1/1	 COOLEY  1/2
06-52-634	160 mm / 6 ¹ / ₄ " Neonatal- und Pädiatrie-Klemme, extra feines Modell <i>Neonatal and Pediatric Clamp, extra delicate pattern</i> <i>Pince pour des nouveaux-nés et des enfants, modèle très fin</i> <i>Pinza clamp para recién nacidos y niños, modelo muy fino</i> <i>Pinza pediátrica per neonate e bambini, modelli molto fini</i>	COOLEY  1/1	 1/2

ATRAUMA

COOLEY

COOLEY

1/1

 Artikel-Nr.
 Cat. No.

 Gesamtlänge
 Total length

06-52-635

 140 mm / 5¹/₂"

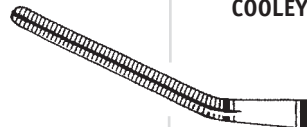
 Neonatal- und Pädiatrie-Klemme
 Neonatal and Pediatric Clamp
 Pince pour des nouveaux-nés et des enfants
 Pinza clamp para recién nacidos y niños
 Pinza pediatrica per neonate e bambini

COOLEY

1/1

06-52-636

 140 mm / 5¹/₂"

 Neonatal- und Pädiatrie-Klemme
 Neonatal and Pediatric Clamp
 Pince pour des nouveaux-nés et des enfants
 Pinza clamp para recién nacidos y niños
 Pinza pediatrica per neonate e bambini

COOLEY

1/1

06-52-637

 140 mm / 5¹/₂"

 Neonatal- und Pädiatrie-Klemme
 Neonatal and Pediatric Clamp
 Pince pour des nouveaux-nés et des enfants
 Pinza clamp para recién nacidos y niños
 Pinza pediatrica per neonate e bambini

ATRAUMA

COOLEY

COOLEY

1/1

06-52-638

 140 mm / 5¹/₂"

 Neonatal- und Pädiatrie-Klemme
 Neonatal and Pediatric Clamp
 Pince pour des nouveaux-nés et des enfants
 Pinza clamp para recién nacidos y niños
 Pinza pediatrica per neonate e bambini

ATRAUMA



COOLEY

Artikel-Nr.
 Cat. No.

Gesamtlänge
 Total length

06-02-765

270 mm / 10³/₄"

Atraumatische Mehrzweckklemme
 Atraumatic Multi-Purpose Clamp
 Pince polyvalente
 Pinza clamp para usos varios
 Pinze atraumatiche per diversi usi

COOLEY

²/₃
 82 mm

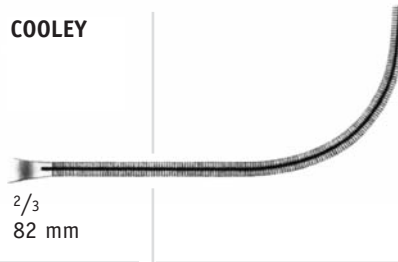

¹/₃

ATRAUMA



COOLEY

06-02-738

260 mm / 10¹/₄"

Atraumatische Mehrzweckklemme
 Atraumatic Multi-Purpose Clamp
 Pince polyvalente
 Pinza clamp para usos varios
 Pinze atraumatiche per diversi usi

COOLEY

¹/₂

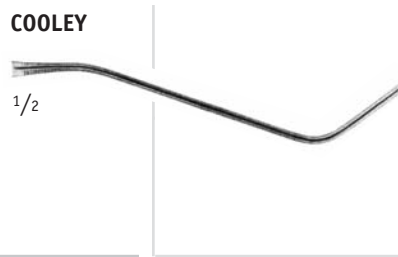

¹/₃

ATRAUMA

COOLEY

 Artikel-Nr.
 Cat. No.

 Gesamtlänge
 Total length

COOLEY
06-02-717

 170 mm / 6³/₄"

 Atraumatische Mehrzweckklemme
 Atraumatic Multi-Purpose Clamp
 Pince polyvalente
 Pinza clamp para usos varios
 Pinze atraumatiche per diversi usi

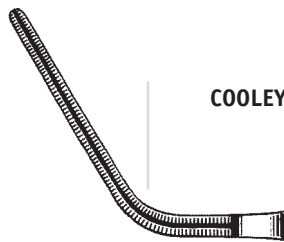
¹/₁
 30°

COOLEY
06-02-718

 155 mm / 6¹/₄"

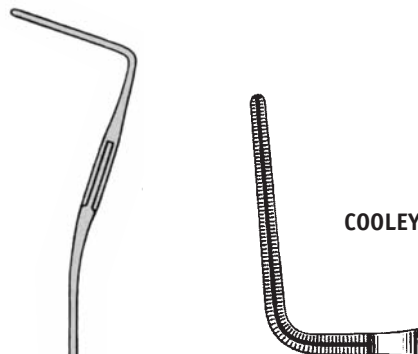
 Atraumatische Mehrzweckklemme
 Atraumatic Multi-Purpose Clamp
 Pince polyvalente
 Pinza clamp para usos varios
 Pinze atraumatiche per diversi usi

¹/₁
 60°

COOLEY
06-02-719

150 mm / 6"

 Atraumatische Mehrzweckklemme
 Atraumatic Multi-Purpose Clamp
 Pince polyvalente
 Pinza clamp para usos varios
 Pinze atraumatiche per diversi usi

¹/₁
 90°

ATRAUMA



COOLEY

Artikel-Nr.
 Cat. No.

Gesamtlänge
 Total length

06-02-730

170 mm / 6³/₄"

Atraumatische Mehrzweckklemme
 Atraumatic Multi-Purpose Clamp
 Pince polyvalente
 Pinza clamp para usos varios
 Pinze atraumatiche per diversi usi

COOLEY

1/1

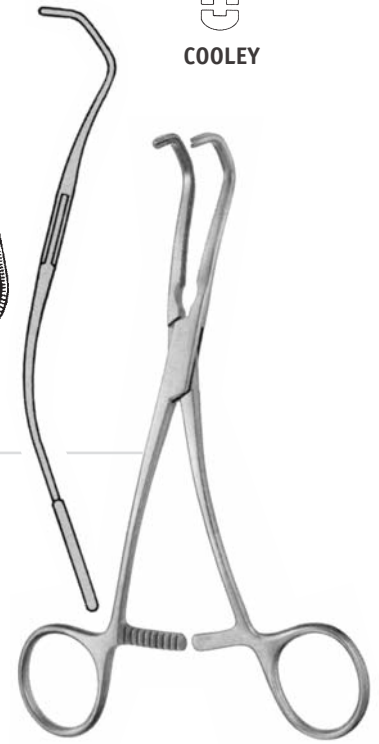
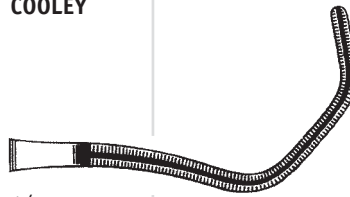

1/2

ATRAUMA



COOLEY

06-02-729

170 mm / 6³/₄"

Atraumatische Mehrzweckklemme
 Atraumatic Multi-Purpose Clamp
 Pince polyvalente
 Pinza clamp para usos varios
 Pinze atraumatiche per diversi usi

COOLEY

1/1

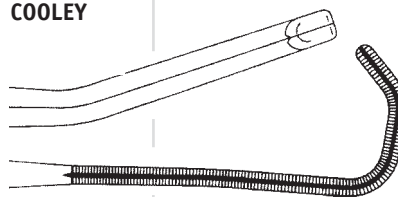

1/2

ATRAUMA

COOLEY

1/2

COOLEY

1/1

COOLEY

1/1

 Artikel-Nr.
 Cat. No.

 Gesamtlänge
 Total length

06-02-710T

 160 mm / 6¹/₄"

Titan · Titanium · Titane · Titanio · Titano

06-02-710

 160 mm / 6¹/₄"

 Coarctationsklemme
 Coarctation Clamp
 Pince pour coarctation
 Pinza para coarctación
 Pinze per coartazione

06-02-712T

 170 mm / 6³/₄"

Titan · Titanium · Titane · Titanio · Titano

06-02-712

 170 mm / 6³/₄"

 Coarctationsklemme
 Coarctation Clamp
 Pince pour coarctation
 Pinza para coarctación
 Pinze per coartazione

ATRAUMA

COOLEY

1/2

COOLEY

1/1

COOLEY

1/1

06-02-711

 160 mm / 6¹/₄"

 Coarctationsklemme
 Coarctation Clamp
 Pince pour coarctation
 Pinza para coarctación
 Pinze per coartazione

06-02-714

 170 mm / 6³/₄"

 Coarctationsklemme
 Coarctation Clamp
 Pince pour coarctation
 Pinza para coarctación
 Pinze per coartazione

ATRAUMA



COOLEY



Artikel-Nr.
 Cat. No.

Gesamtlänge
 Total length

06-02-713T

170 mm / 6³/₄"

Titan · Titanium · Titane · Titanio · Titanio

COOLEY

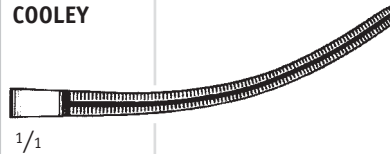

1/1

06-02-713

170 mm / 6³/₄"

Coarctationsklemme
 Coarctation Clamp
 Pince pour coarctation
 Pinza para coarctación
 Pinze per coartazione

06-02-715T

170 mm / 6³/₄"

Titan · Titanium · Titane · Titanio · Titanio

COOLEY



1/1

06-02-715

170 mm / 6³/₄"

Coarctationsklemme
 Coarctation Clamp
 Pince pour coarctation
 Pinza para coarctación
 Pinze per coartazione

ATRAUMA

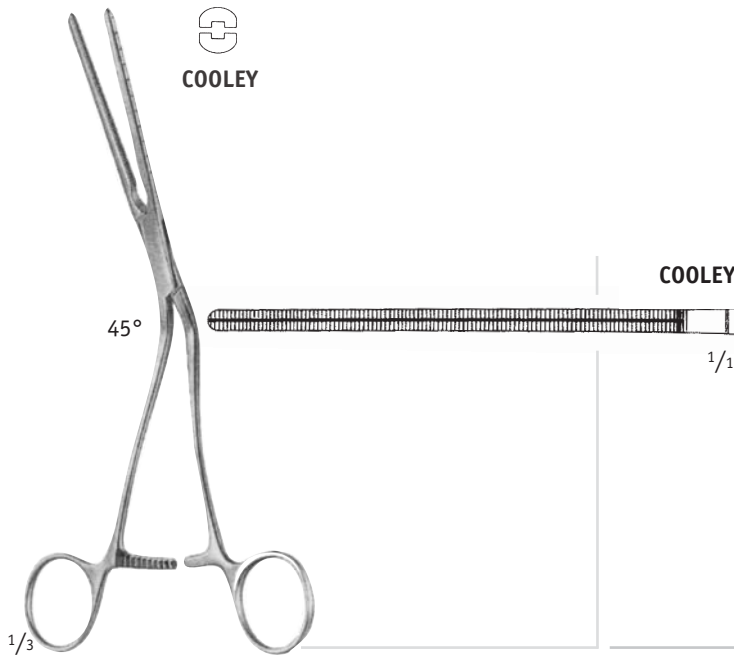
COOLEY

 Artikel-Nr.
 Cat. No.

 Gesamtlänge
 Total length

06-52-720T

 210 mm / 8¹/₄"

Titan · Titanium · Titane · Titanio · Titanio

06-52-720

 210 mm / 8¹/₄"

06-52-721T

250 mm / 10"

Titan · Titanium · Titane · Titanio · Titanio

06-52-721

250 mm / 10"

Iliaca-Klemme

Iliac Clamp · Pince pour veine iliaque
Pinza clamp para iliaca · Pinza per iliaca
ATRAUMA

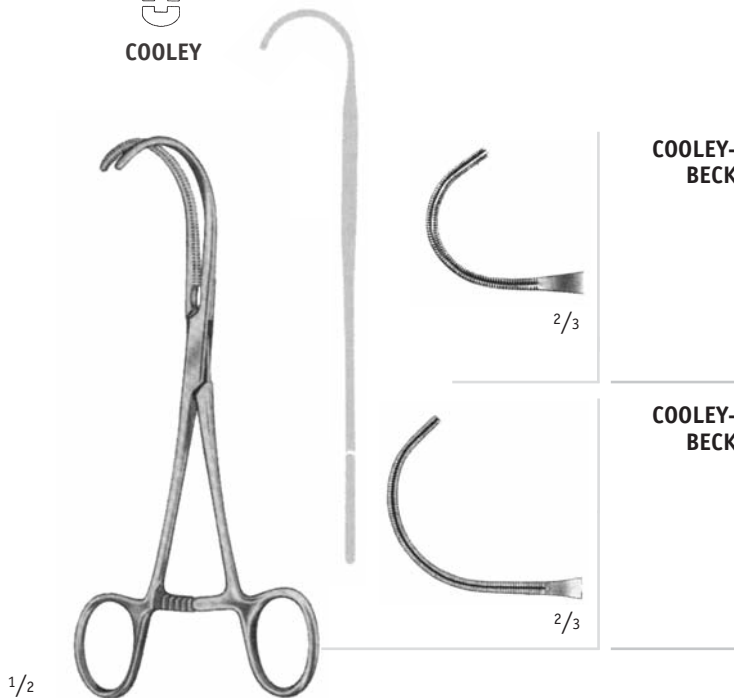
COOLEY

**COOLEY-
BECK**
06-02-731T

150 mm / 6"

Titan · Titanium · Titane · Titanio · Titanio

06-02-731

150 mm / 6"

Anastomosenklemme

Anastomosis Clamp · Pince à anastomose
Pinza para anastomosis · Pinze per anastomosi
**COOLEY-
BECK**
06-02-732T

155 mm / 6"

Titan · Titanium · Titane · Titanio · Titanio

06-02-732

155 mm / 6"

Anastomosenklemme

Anastomosis Clamp · Pince à anastomose
Pinza para anastomosis · Pinze per anastomosi



Artikel-Nr.
 Cat. No.

Gesamtlänge
 Total length

06-02-733

170 mm / 6³/₄"

Anastomosenklemme
 Anastomosis Clamp
 Pince à anastomose
 Pinza para anastomosis
 Pinze per anastomosi

COOLEY

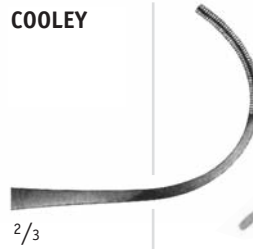

2/3

ATRAUMA



COOLEY

06-02-734

170 mm / 6³/₄"

Anastomosenklemme
 Anastomosis Clamp
 Pince à anastomose
 Pinza para anastomosis
 Pinze per anastomosi

COOLEY

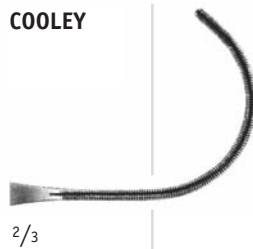

2/3



1/2

06-02-735

170 mm / 6³/₄"

Anastomosenklemme
 Anastomosis Clamp
 Pince à anastomose
 Pinza para anastomosis
 Pinze per anastomosi

COOLEY

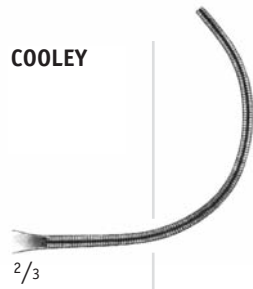

2/3

ATRAUMA

COOLEY

**COOLEY-
DERRA**

 Artikel-Nr.
 Cat. No.

 Gesamtlänge
 Total length

06-02-725

 160 mm / 6¹/₄"

 Anastomosenklemme
 Anastomosis Clamp
 Pince à anastomose
 Pinza para anastomosis
 Pinze per anastomosi

1/1

**COOLEY-
DERRA**
06-02-726

 170 mm / 6³/₄"

 Anastomosenklemme
 Anastomosis Clamp
 Pince à anastomose
 Pinza para anastomosis
 Pinze per anastomosi

1/1

**COOLEY-
DERRA**
06-02-727

180 mm / 7"

 Anastomosenklemme
 Anastomosis Clamp
 Pince à anastomose
 Pinza para anastomosis
 Pinze per anastomosi

1/1

Artikel-Nr. Cat. No.	Gesamtlänge Total length
06-02-721T	165 mm / 6 ¹ / ₂ " Titan · Titanium · Titane · Titanio · Titanio
06-02-721	165 mm / 6 ¹ / ₂ " Anastomosenklemme Anastomosis Clamp · Pince à anastomose Pinza para anastomosis · Pinze per anastomosi

COOLEY

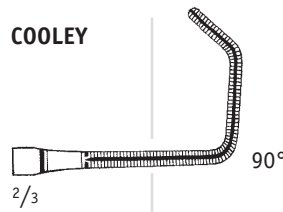

ATRAUMA



COOLEY

06-02-722T	165 mm / 6 ¹ / ₂ " Titan · Titanium · Titane · Titanio · Titanio
06-02-722	165 mm / 6 ¹ / ₂ " Anastomosenklemme Anastomosis Clamp · Pince à anastomose Pinza para anastomosis · Pinze per anastomosi

COOLEY

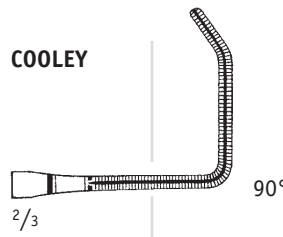

06-02-723T	175 mm / 7" Titan · Titanium · Titane · Titanio · Titanio
06-02-723	175 mm / 7" Anastomosenklemme Anastomosis Clamp · Pince à anastomose Pinza para anastomosis · Pinze per anastomosi

COOLEY

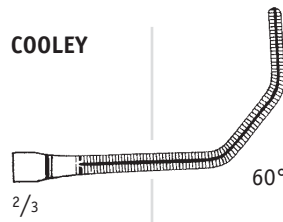

06-02-724T	175 mm / 7" Titan · Titanium · Titane · Titanio · Titanio
06-02-724	175 mm / 7" Anastomosenklemme Anastomosis Clamp · Pince à anastomose Pinza para anastomosis · Pinze per anastomosi

COOLEY

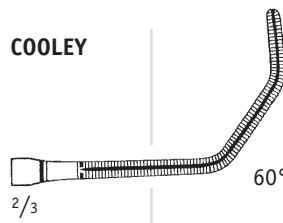

ATRAUMA

COOLEY

1/2

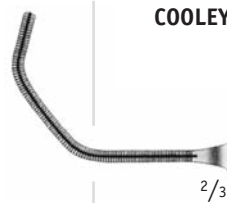

COOLEY

 Artikel-Nr.
 Cat. No.

06-02-776

 Gesamtlänge
 Total length

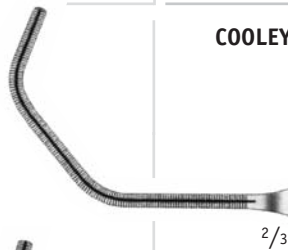
205 mm / 8"

 Tangentialklemme
 Tangential Occlusion Clamp
 Pince pour occlusion tangentielle
 Pinza para oclusión tangencial
 Pinze per occlusione tangenziale

COOLEY
06-02-777

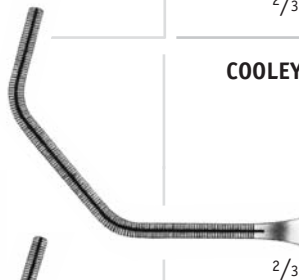
 260 mm / 10¹/₄"

 Tangentialklemme
 Tangential Occlusion Clamp
 Pince pour occlusion tangentielle
 Pinza para oclusión tangencial
 Pinze per occlusione tangenziale

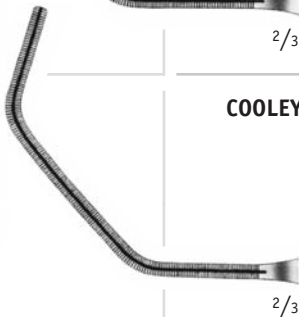
COOLEY
06-02-778

 260 mm / 10¹/₂"

 Tangentialklemme
 Tangential Occlusion Clamp
 Pince pour occlusion tangentielle
 Pinza para oclusión tangencial
 Pinze per occlusione tangenziale

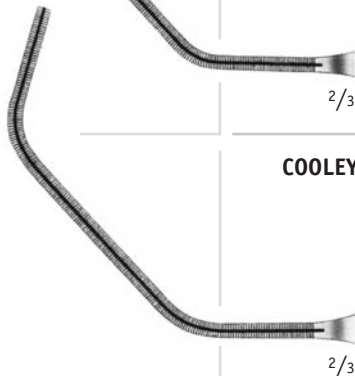
COOLEY
06-02-779

 260 mm / 10¹/₂"

 Tangentialklemme
 Tangential Occlusion Clamp
 Pince pour occlusion tangentielle
 Pinza para oclusión tangencial
 Pinze per occlusione tangenziale

COOLEY
06-02-780

 275 mm / 10³/₄"

 Tangentialklemme
 Tangential Occlusion Clamp
 Pince pour occlusion tangentielle
 Pinza para oclusión tangencial
 Pinze per occlusione tangenziale

ATRAUMA



COOLEY



1/2

Artikel-Nr.
 Cat. No.

Gesamtlänge
 Total length

06-02-736T	185 mm / 7 ¹ / ₄ " Titan · Titanium · Titane · Titano · Titanio
06-02-736	185 mm / 7 ¹ / ₄ " Carotis-Shuntklemme Carotid Shunt Clamp · Pince pour carotide Pinza para carótido · Pinze carotis
06-02-737T	195 mm / 7 ³ / ₄ " Titan · Titanium · Titane · Titano · Titanio
06-02-737	195 mm / 7 ³ / ₄ " Carotis-Shuntklemme Carotid Shunt Clamp · Pince pour carotide Pinza para carótido · Pinze carotis

COOLEY



1/1

COOLEY

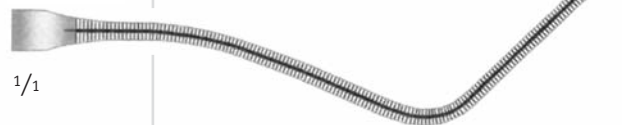

1/1



2



FOGARTY

 Artikel-Nr.
 Cat. No.

06-52-580

 Gesamtlänge
 Total length
165 mm / 6¹/₂"
 Maullänge: 33 mm
 Length of jaws: 33 mm
 Longueur des mors: 33 mm
 Longitud de la boca: 33 mm
 Lunghezza del morso: 33 mm

FOGARTY





06-52-581

290 mm / 11¹/₂"
 Maullänge: 61 mm
 Length of jaws: 61 mm
 Longueur des mors: 61 mm
 Longitud de la boca: 61 mm
 Lunghezza del morso: 61 mm

FOGARTY

06-52-582

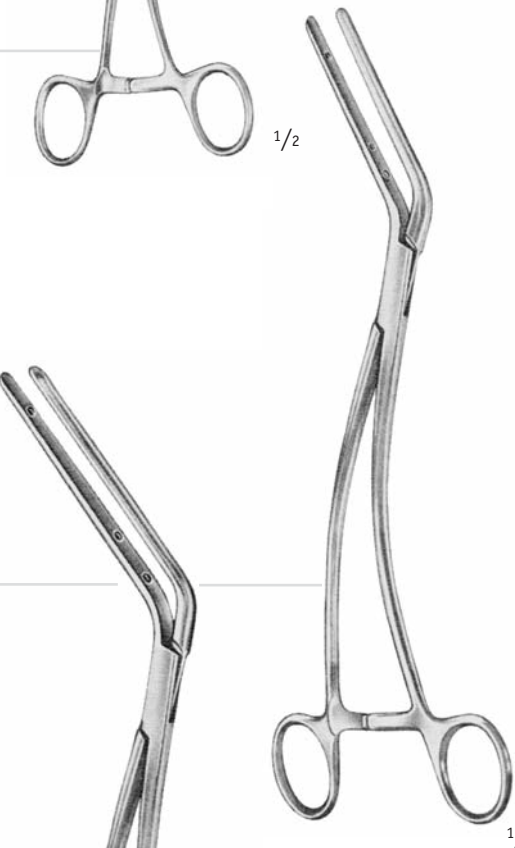
220 mm / 8³/₄"
 Maullänge: 61 mm
 Length of jaws: 61 mm
 Longueur des mors: 61 mm
 Longitud de la boca: 61 mm
 Lunghezza del morso: 61 mm

Artikel-Nr. Cat. No.	Gesamtlänge Total length	FOGARTY	
06-52-583	120 mm / 4 ³ / ₄ " Maullänge: 33 mm <i>Length of jaws: 33 mm</i> <i>Longueur des mors: 33 mm</i> <i>Longitud de la boca: 33 mm</i> <i>Lunghezza del morso: 33 mm</i>	FOGARTY	
06-52-584	215 mm / 8 ¹ / ₂ " Maullänge: 61 mm <i>Length of jaws: 61 mm</i> <i>Longueur des mors: 61 mm</i> <i>Longitud de la boca: 61 mm</i> <i>Lunghezza del morso: 61 mm</i>	FOGARTY	
06-52-585	235 mm / 8 ¹ / ₄ " Maullänge: 86 mm <i>Length of jaws: 86 mm</i> <i>Longueur des mors: 86 mm</i> <i>Longitud de la boca: 86 mm</i> <i>Lunghezza del morso: 86 mm</i>	FOGARTY	

**FOGARTY
Hydrajaw®**

 Artikel-Nr.
Cat. No.

 Gesamtlänge
Total length

06-52-586

33 mm

06-52-587

61 mm

06-52-588

86 mm

Hydrajaw® Einsatz-Set, bestehend aus
1x Hydrajaw®-Insert und 1x Tractionjaw-Insert
- Hohl Gummi (mit medizinischem Silikon ausgefüllt)
- Steril

Hydrajaw® insert-set

- one Hydrajaw®-insert and one Tractionjaw-insert
- made of hollow rubber (filled with medicalgrade silicone)
- sterile

Hydrajaw® set d'insert

- Un Hydrajaw®-insert et un Tractionjaw-insert
- Faite de caoutchouc creux (rempli de silicone de qualité médicale)
- Stérile

Hydrajaw® insertar-set

- Un Hydrajaw® a insertar y un Tractionjaw a insertar
- De goma hueco (llena de silicona de grado médico)
- Estéril

Hydrajaw® inserire-set

- Uno Hydrajaw®-insert e uno Tractionjaw-insert
- In gomma cava (riempito con medico-silicone)
- Sterile

**FOGARTY
Softjaw®**

 Artikel-Nr.
Cat. No.

 Gesamtlänge
Total length

06-52-589

33 mm

06-52-590

61 mm

06-52-591

86 mm

Softjaw® Einsatz-Set
1x Softjaw®-Insert und 1x Tractionjaw-Insert
- Aus elastischem Moosgummi, latex-frei
- Einwegverfahren
- Steril

Softjaw® insert-set

- One Softjaw®-insert and one Tractionjaw-insert
- made of resilient latex-free sponge rubber
- single-use
- Sterile

Softjaw® set d'insert

- Un Softjaw®-insert et un Tractionjaw-insert
- Faite de caoutchouc de mousse, élastique, sans latex
- jetable
- Stérile

Softjaw® insertar-set

- Un Softjaw® a insertar y un Tractionjaw a insertar
- De látex de caucho resistente esponja libre
- mono uso
- Estéril

Softjaw® inserire-set

- Uno Softjaw®-insert e uno Tractionjaw-insert
- In lattice di gomma elastica senza spugna
- mono uso
- Sterile

Artikel-Nr. Cat. No.	Gesamtlänge Total length	EDWARDS
06-52-592	185 mm / 7 ¹ / ₄ "	
Anlegezange für Edwards Clips Applying forceps for Edwards Clips Applicateur pour Edwards clips Pinza para aplicar Edwards clips Applicatore per Edwards clips		

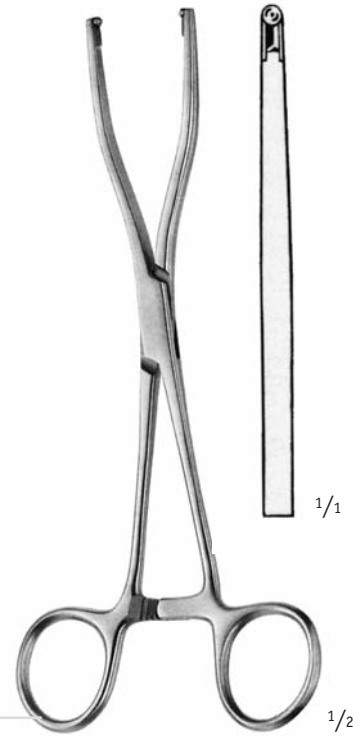

06-52-593	6 mm	EDWARDS
06-52-594	12 mm	
Clips Clips · Clips · Clips · Clips		

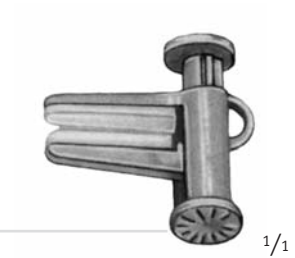

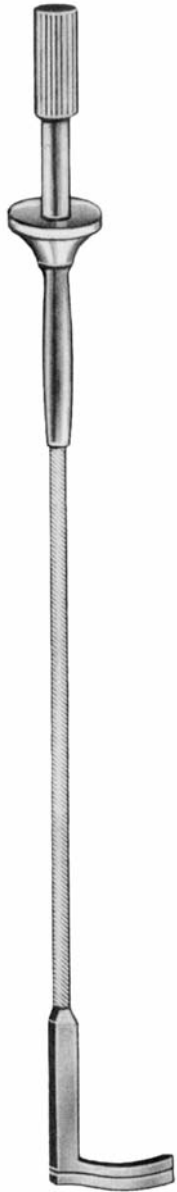

1/2

 Artikel-Nr.
 Cat. No.

 Gesamtlänge
 Total length

06-52-640

200 mm / 8"

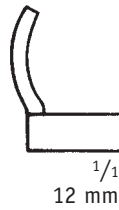
 Glattes Maul
 Plain Jaw
 Mors lisse
 Boca lisa
 Morso liscio

06-52-641

200 mm / 8"

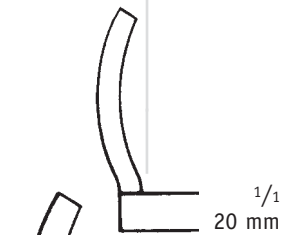
 Glattes Maul
 Plain Jaw
 Mors lisse
 Boca lisa
 Morso liscio

06-52-642

200 mm / 8"

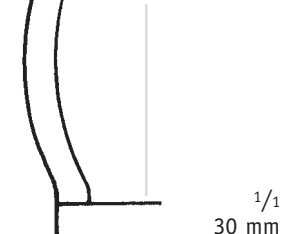
 Glattes Maul
 Plain Jaw
 Mors lisse
 Boca lisa
 Morso liscio

06-52-643

200 mm / 8"

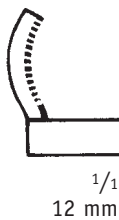
 Atraumatisches Maul
 Automatic Jaw
 Mors atraumatique
 Bocas atraumáticas
 Morso atraumatiche

06-52-644



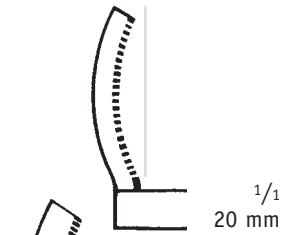

200 mm / 8"

 Atraumatisches Maul
 Automatic Jaw
 Mors atraumatique
 Bocas atraumáticas
 Morso atraumatiche

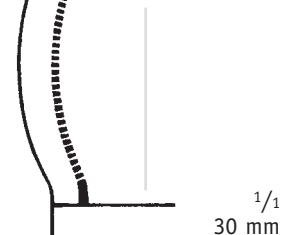
06-52-645

200 mm / 8"

 Atraumatisches Maul
 Automatic Jaw
 Mors atraumatique
 Bocas atraumáticas
 Morso atraumatiche

Artikel-Nr. Cat. No.	Gesamtlänge Total length		
06-52-646	200 mm / 8"	Shunt Shunt Shunt Derivación Shunt	 1/1 ø 3 mm
06-52-647	200 mm / 8"	Shunt Shunt Shunt Derivación Shunt	 1/1 ø 5 mm
06-52-648	200 mm / 8"	Shunt Shunt Shunt Derivación Shunt	 1/1 ø 7 mm
06-52-649	200 mm / 8"	Shunt Shunt Shunt Derivación Shunt	 1/1 ø 9 mm





Bulldogklemmen, Gefäßclips
Bulldog Clamps, Vessel Clips · Clamps Bulldog, Clips vasculaires
Clamps Bulldog, Clips vasculares · Pinze Bulldog, Clips vascolari

// 01

Atraumatische Gefäßklemmen
Atraumatic Vascular Clamps · Pincés vasculaires atraumatiques
Pinzas vasculares atraumáticas · Pinze vascolari atraumatiche

// 02

Atraumatische Pinzetten
Atraumatic Tissue Forceps · Pincés atraumatiques
Pinzas atraumáticas · Pinze atraumatiche

// 03

Rippensperrer
Rib Spreaders · Ecarteurs pour costaux
Separadores costales · Divaricatori costali

// 04

Atrium, Aorta-Instrumente
Atrium-, Aortic Instruments · Instruments pour l'oreillette et l'aorte
Instrumentos para el atrium y la aorta · Strumenti per atrio e aorta

// 05

Wundhaken, Wundspreizer
Retractors · Ecarteurs
Separadores · Divaricatori

// 06

Sonden, Dilatationsinstrumente
Probes, Instruments for dilatation · Sondes, Instruments pour la dilatation
Sondas, Instrumentos para la dilatación · Sonda, Strumenti a dilatazione

// 07

Mikro-Instrumente
Micro Instruments · Micro instruments
Instrumentos para microcirugía · strumenti per microchirurgia

// 08

Allgemeinchirurgische Instrumente
General surgery instruments · Instruments pour la chirurgie générale
Instrumentos para la cirugía general · Strumenti per chirurgia generale

// 09

Orthopädische Instrumente
Orthopaedic Instruments · Instruments pour l'orthopédie
Instrumentos para ortopedia · Strumenti per ortopedia

// 10

ATRAUMA**DE BAKEY**

1,5 mm 1/1

DE BAKEYArtikel-Nr.
Cat. No.Gesamtlänge
Total length

06-02-411

160 mm / 6¹/₄"

06-02-412

200 mm / 8"

06-52-100

240 mm / 9¹/₂"

06-52-101

300 mm / 12"

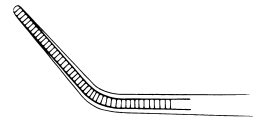

1,5 mm 1/1

DE BAKEY

06-52-102

160 mm / 6¹/₄"

06-52-103

200 mm / 8"

06-52-104

240 mm / 9¹/₂"

06-52-105

300 mm / 12"



2,0 mm 1/1

DE BAKEY

06-02-400

160 mm / 6¹/₄"

06-02-402

200 mm / 8"

06-02-404

240 mm / 9¹/₂"

06-02-405

300 mm / 12"

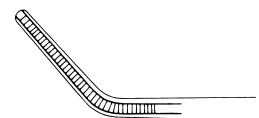

2,0 mm 1/1

DE BAKEY

06-02-401

160 mm / 6¹/₄"

06-02-403

200 mm / 8"

06-52-119

240 mm / 9¹/₂"

06-52-120

300 mm / 12"



2,4 mm 1/1

DE BAKEY

06-52-106

160 mm / 6¹/₄"

06-52-107

200 mm / 8"

06-52-108

240 mm / 9¹/₂"

06-52-109

300 mm / 12"

ATRAUMA



DE BAKEY



1/1

Artikel-Nr. Cat. No.	Gesamtlänge Total length		
06-02-411T	160 mm / 6 ¹ / ₄ "	DE BAKEY	 1/1 1,5 mm
06-02-412T	200 mm / 8"		
06-52-100T	240 mm / 9 ¹ / ₂ "		
06-52-101T	300 mm / 12"		
06-02-400T	160 mm / 6 ¹ / ₄ "	DE BAKEY	 1/1 2,0 mm
06-02-402T	200 mm / 8"		
06-02-404T	240 mm / 9 ¹ / ₂ "		
06-02-405T	300 mm / 12"		
06-02-401T	160 mm / 6 ¹ / ₄ "	DE BAKEY	 1/1 2,0 mm
06-02-403T	200 mm / 8"		
06-52-119T	240 mm / 9 ¹ / ₂ "		
06-52-120T	300 mm / 12"		
06-52-106T	160 mm / 6 ¹ / ₄ "	DE BAKEY	 1/1 2,4 mm
06-52-107T	200 mm / 8"		
06-52-108T	240 mm / 9 ¹ / ₂ "		
06-52-109T	300 mm / 12"		

ATRAUMA

DE BAKEY

1/1

	Artikel-Nr. Cat. No.	Gesamtlänge Total length
 2,8 mm 1/1	DE BAKEY 06-02-414	160 mm / 6 ¹ / ₄ "
	06-02-415	200 mm / 8"
	06-02-416	240 mm / 9 ¹ / ₂ "
	06-02-417	300 mm / 12"
 2,8 mm 1/1	DE BAKEY 06-52-110	160 mm / 6 ¹ / ₄ "
	06-52-111	200 mm / 8"
	06-52-112	240 mm / 9 ¹ / ₂ "
	06-52-113	300 mm / 12"
 3,5 mm 1/1	DE BAKEY 06-52-114	160 mm / 6 ¹ / ₄ "
	06-52-115	200 mm / 8"
	06-52-116	240 mm / 9 ¹ / ₂ "
	06-52-117	300 mm / 12"
 3,5 mm 1/1	DE BAKEY 06-52-118	160 mm / 6 ¹ / ₄ "
	06-02-406	200 mm / 8"
	06-02-407	240 mm / 9 ¹ / ₂ "
	06-02-408	300 mm / 12"

ATRAUMA



DE BAKEY



1/1

Artikel-Nr.
 Cat. No.

Gesamtlänge
 Total length

06-02-414T	160 mm / 6 ¹ / ₄ "
06-02-415T	200 mm / 8"
06-02-416T	240 mm / 9 ¹ / ₂ "
06-02-417T	300 mm / 12"

DE BAKEY



1/1

2,8 mm

06-52-114T	160 mm / 6 ¹ / ₄ "
06-52-115T	200 mm / 8"
06-52-116T	240 mm / 9 ¹ / ₂ "
06-52-117T	300 mm / 12"

DE BAKEY



1/1

3,5 mm

ATRAUMA

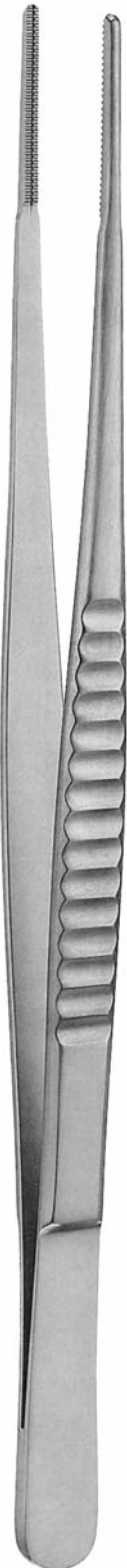
COOLEY

2,0 mm

COOLEY

 Artikel-Nr.
 Cat. No.

 Gesamtlänge
 Total length

06-02-784

 160 mm / 6¹/₄"

06-02-785

200 mm / 8"

06-52-786

 240 mm / 9¹/₂"

1/1

ATRAUMA



DE BAKEY



1/1

Artikel-Nr.
 Cat. No.

Gesamtlänge
 Total length

06-02-394

150 mm / 6"

DE BAKEY



1/1 1,0 mm

06-02-395

195 mm / 7³/₄"

06-02-396

240 mm / 9¹/₂"

06-52-410

150 mm / 6"

**DE BAKEY-
 DIETRICH**



1/1 1,5 mm

06-52-411

195 mm / 7³/₄"

06-52-412

240 mm / 9¹/₂"

ATRAUMA

DE BAKEY

1/2

		Artikel-Nr. Cat. No.	Gesamtlänge Total length
 1,2 mm 1/1	DE BAKEY	06-03-411	150 mm / 6"
 1,5 mm 1/1	DE BAKEY	06-03-412	200 mm / 8"
 1,5 mm 1/1	DE BAKEY	06-03-413	240 mm / 9 ¹ / ₂ "
 1,5 mm 1/1	DE BAKEY	06-03-418	300 mm / 12"

ATRAUMA



DE BAKEY



1/2

Artikel-Nr.
 Cat. No.

Gesamtlänge
 Total length

06-52-250

120 mm / 4³/₄"

**DE BAKEY-
 ADSON**



1/1

06-52-251

150 mm / 6"

ATRAUMA



DE BAKEY



1/2

06-52-252

150 mm / 4³/₄"

**DE BAKEY-
 GERALD**



1/1

06-52-253

180 mm / 6"

ATRAUMA

DE BAKEY

1/2



1/1

**DE BAKEY-
WHEELER**

 Artikel-Nr.
 Cat. No.

 Gesamtlänge
 Total length

06-52-254

150 mm / 6"

06-52-255

 195 mm / 7³/₄"

06-52-256

 240 mm / 9¹/₂"

ATRAUMA

1/2



1/1









GLASSMAN
06-52-257

 150 mm / 6"
 4 mm

1/1

GLASSMAN
06-52-258

 240 mm / 9¹/₂"
 8 mm

Artikel-Nr. Cat. No.	Gesamtlänge Total length		
06-52-260	150 mm / 6"	CHITWOOD- DE BAKEY	 1,5 mm 2 x 4
06-52-261	195 mm / 7 ³ / ₄ "		
06-52-262	240 mm / 9 ¹ / ₂ "		
06-52-263	150 mm / 6"	CHITWOOD- DE BAKEY	 2,0 mm 2 x 4
06-52-264	195 mm / 7 ³ / ₄ "		
06-52-265	240 mm / 9 ¹ / ₂ "		
06-52-266	150 mm / 6"	CHITWOOD- DE BAKEY	 2,7 mm 2 x 4
06-52-267	195 mm / 7 ³ / ₄ "		
06-52-268	240 mm / 9 ¹ / ₂ "		
06-52-269	150 mm / 6"	CHITWOOD- DE BAKEY	 3,5 mm 2 x 4
06-52-270	195 mm / 7 ³ / ₄ "		
06-52-271	240 mm / 9 ¹ / ₂ "		
06-52-272	150 mm / 6"	CHITWOOD- DE BAKEY	 1,5 mm 6 x 12
06-52-273	195 mm / 7 ³ / ₄ "		
06-52-274	240 mm / 9 ¹ / ₂ "		
06-52-275	150 mm / 6"	CHITWOOD- DE BAKEY	 2,0 mm 6 x 12
06-52-276	195 mm / 7 ³ / ₄ "		
06-52-277	240 mm / 9 ¹ / ₂ "		
06-52-278	150 mm / 6"	CHITWOOD- DE BAKEY	 2,7 mm 6 x 12
06-52-279	195 mm / 7 ³ / ₄ "		
06-52-280	240 mm / 9 ¹ / ₂ "		
06-52-281	150 mm / 6"	CHITWOOD- DE BAKEY	 3,5 mm 6 x 12
06-52-282	195 mm / 7 ³ / ₄ "		
06-52-283	240 mm / 9 ¹ / ₂ "		

ATRAUMA



DE BAKEY



TC

ATRAUMA

DE BAKEY

1/1

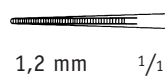

1,2 mm 1/1

DE BAKEY

 Artikel-Nr.
 Cat. No.

 Gesamtlänge
 Total length

06-54-925

150 mm / 6"

06-54-926

180 mm / 7"

06-54-927

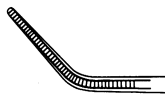
210 mm / 8¹/₄"

1,2 mm 1/1

DE BAKEY

06-54-928

150 mm / 6"

06-54-929

180 mm / 7"

06-54-930

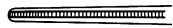
210 mm / 8¹/₄"

1,8 mm 1/1

DE BAKEY

06-54-931

150 mm / 6"

06-54-932

180 mm / 7"

06-54-933

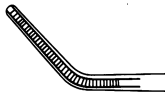
210 mm / 8¹/₄"

1,8 mm 1/1

DE BAKEY

06-54-934

150 mm / 6"

06-54-935

180 mm / 7"

06-54-936

210 mm / 8¹/₄"

Lieferbare Ausführungen · deliverable models · modèles disponibles · modelos disponibles · modelli disponibili

Standard Line

Oberfläche matt gebürstet

Surface polished · Surface brossée mate ·

Superficie cepillada mate · Superficie spazzolata

Bestellbeispiel

How to order · Exemple pour commander · Ejemplo para pedir · Esempio per comandare: 06-54-925

Black Line

Oberfläche schwarz, titanbeschichtet · Surface black, titanium-coated · Surface noir, enduite de titane · Superficie negra, recubierto de titanio · Superficie nera, ricoperta di titanio

Bestellbeispiel

How to order · Exemple pour commander · Ejemplo para pedir · Esempio per comandare: 06-54-925 B

ATRAUMA



DE BAKEY

Artikel-Nr. Cat. No.	Gesamtlänge Total length	DE BAKEY	
06-54-925T	150 mm / 6"	DE BAKEY	1/1 1,2 mm
06-54-926T	180 mm / 7"		
06-54-927T	210 mm / 8 ¹ / ₄ "		
06-54-928T	150 mm / 6"	DE BAKEY	1/1 1,2 mm
06-54-929T	180 mm / 7"		
06-54-930T	210 mm / 8 ¹ / ₄ "		
06-54-931T	150 mm / 6"	DE BAKEY	1/1 1,8 mm
06-54-932T	180 mm / 7"		
06-54-933T	210 mm / 8 ¹ / ₄ "		
06-54-934T	150 mm / 6"	DE BAKEY	1/1 1,8 mm
06-54-935T	180 mm / 7"		
06-54-936T	210 mm / 8 ¹ / ₄ "		



1/1

ATRAUMA

DE BAKEY

¹/₁

1,2 mm

¹/₁
DE BAKEY

 Artikel-Nr.
 Cat. No.

 Gesamtlänge
 Total length

06-54-980

150 mm / 6"

06-54-981

180 mm / 7"

06-54-982

210 mm / 8¹/₄"
 mit Gegengewicht
 with counter weight · avec contre-poids
 con contrapeso · con contrappeso

1,2 mm

¹/₁
DE BAKEY

06-54-983

150 mm / 6"

06-54-984

180 mm / 7"

06-54-985

210 mm / 8¹/₄"
 mit Gegengewicht
 with counter weight · avec contre-poids
 con contrapeso · con contrappeso

Lieferbare Ausführungen · deliverable models · modèles disponibles · modelos disponibles · modelli disponibili

Standard Line

Oberfläche matt gebürstet

Surface polished · Surface brossée mate

Superficie cepillada mate · Superficie spazzolata

Bestellbeispiel

How to order · Exemple pour commander · Ejemplo para pedir · Esempio per comandare: 06-54-925

Black Line

Oberfläche schwarz, titanbeschichtet · Surface black, titanium-coated · Surface noir, enduite de titane · Superficie negra, recubierto de titanio · Superficie nera, ricoperta di titanio

Bestellbeispiel

How to order · Exemple pour commander · Ejemplo para pedir · Esempio per comandare: 06-54-925 B

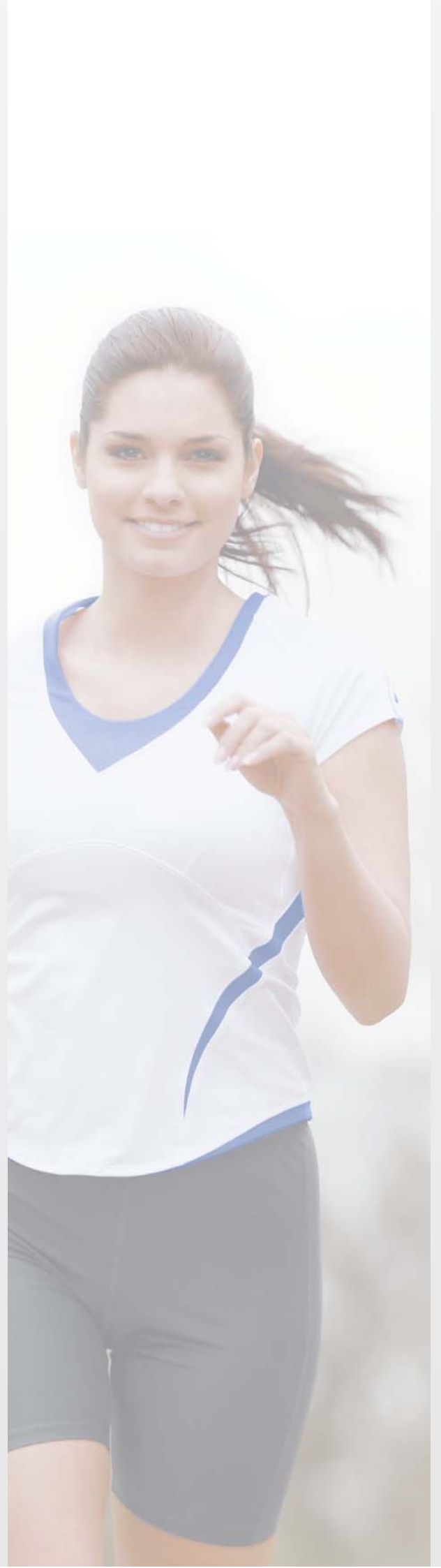

Bulldogklemmen, Gefäßclips
Bulldog Clamps, Vessel Clips · Clamps Bulldog, Clips vasculaires
Clamps Bulldog, Clips vasculares · Pinze Bulldog, Clips vascolari

// 01

Atraumatische Gefäßklemmen
Atraumatic Vascular Clamps · Pincés vasculaires atraumatiques
Pinzas vasculares atraumáticas · Pinze vascolari atraumatiche

// 02

Atraumatische Pinzetten
Atraumatic Tissue Forceps · Pincés atraumatiques
Pinzas atraumáticas · Pinze atraumatiche

// 03

Rippensperrer
Rib Spreaders · Ecarteurs pour costaux
Separadores costales · Divaricatori costali

// 04

Atrium, Aorta-Instrumente
Atrium-, Aortic Instruments · Instruments pour l'oreillette et l'aorte
Instrumentos para el atrium y la aorta · Strumenti per atrio e aorta

// 05

Wundhaken, Wundspreizer
Retractors · Ecarteurs
Separadores · Divaricatori

// 06

Sonden, Dilatationsinstrumente
Probes, Instruments for dilatation · Sondes, Instruments pour la dilatation
Sondas, Instrumentos para la dilatación · Sonda, Strumenti a dilatazione

// 07

Mikro-Instrumente
Micro Instruments · Micro instruments
Instrumentos para microcirugía · strumenti per microchirurgia

// 08

Allgemeinchirurgische Instrumente
General surgery instruments · Instruments pour la chirurgie générale
Instrumentos para la cirugía general · Strumenti per chirurgia generale

// 09

Orthopädische Instrumente
Orthopaedic Instruments · Instruments pour l'orthopédie
Instrumentos para ortopedia · Strumenti per ortopedia

// 10

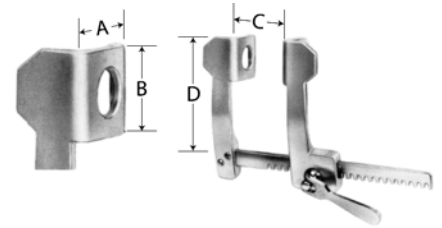

**COOLEY**
 Artikel-Nr.
 Cat. No.
06-52-800

A B C D

10 mm 15,5 mm 75 mm 55 mm

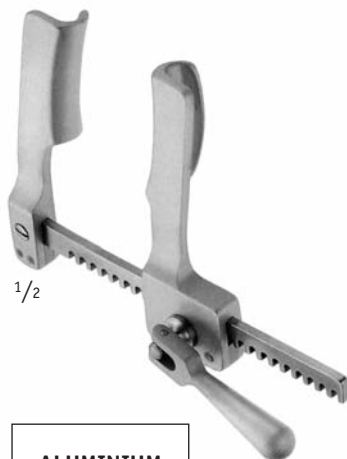
 für Neugeborene
for neonates · pour nouveaux-nés · para recién-nacidos · per neonati
**CASTAÑEDA****06-52-801**

9 mm 34 mm 70 mm 55 mm

 für Neugeborene
for neonates · pour nouveaux-nés · para recién-nacidos · per neonati
06-52-802

11 mm 45 mm 80 mm 80 mm

 für Säuglinge
for babies · pour bébés · para bebés · per neonati
06-52-803

15 mm 60 mm 120 mm 125 mm

 für Kinder
for children · pour enfants · para niños · per bambini
ALUMINIUM

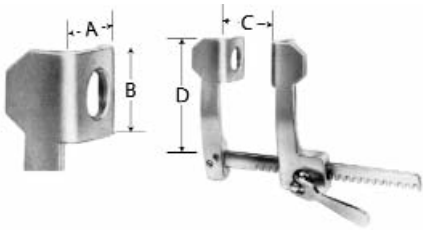

Artikel-Nr.
 Cat. No.

A B C D

06-03-040

12 mm 15 mm 100 mm 55 mm

für Säuglinge
 for babies · pour bébés · para bebés · per neonati

**FINO-
 CHIETTO**

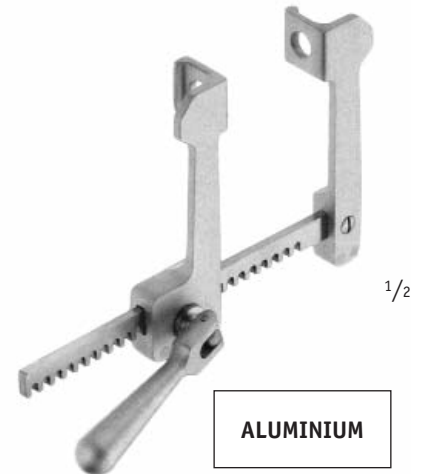

ALUMINIUM

06-52-804

14 mm 20 mm 120 mm 105 mm

für Säuglinge
 for babies · pour bébés · para bebés · per neonati

**FINO-
 CHIETTO
 (MODIF.)**



ALUMINIUM

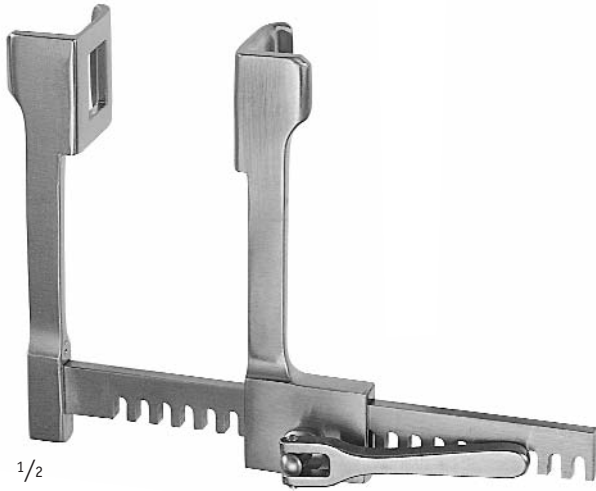

1/2

FINO-CHIETTO-BABY

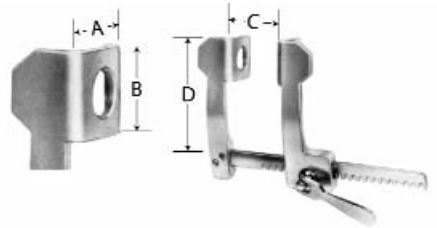
 Artikel-Nr.
 Cat. No.
06-02-830

A B C D

14 mm 15 mm 75 mm 55 mm

für Säuglinge

for babies · pour bébés · para bebés · per neonati

1/2

COOLEY**06-52-806**

12 mm 17 mm 95 mm 55 mm

für Säuglinge

for babies · pour bébés · para bebés · per neonati
06-52-807

20 mm 24 mm 100 mm 80 mm

für Säuglinge

for babies · pour bébés · para bebés · per neonati
ALUMINIUM

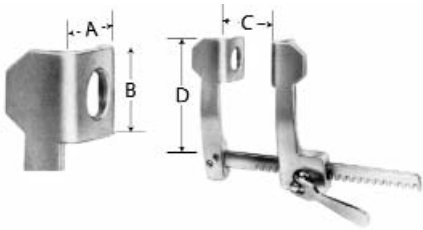

Artikel-Nr.
 Cat. No.

A B C D

06-52-810

12 mm 20 mm 95 mm 75 mm

WEINBERG

für Kinder
 for children · pour enfants · para niños · per bambini



ALUMINIUM

06-52-811

15 mm 30 mm 140 mm 80 mm

COOLEY

06-52-812

29 mm 34 mm 140 mm 110 mm

für Kinder
 for children · pour enfants · para niños · per bambini



ALUMINIUM

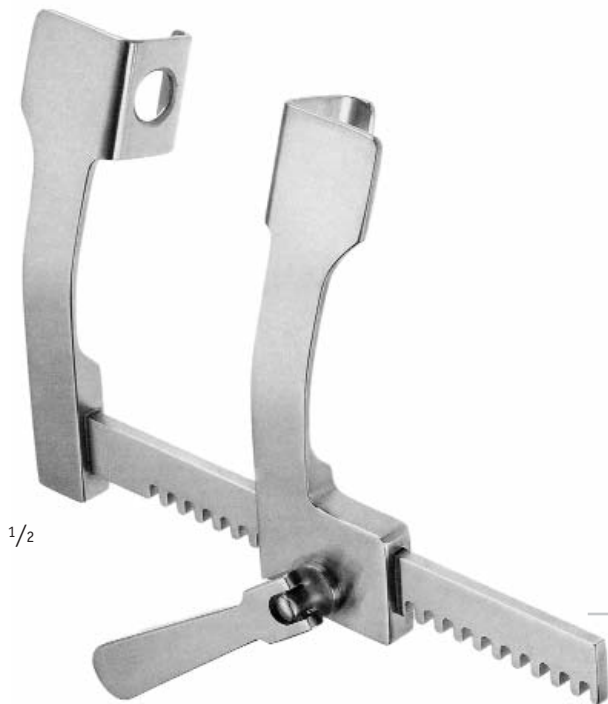

1/2

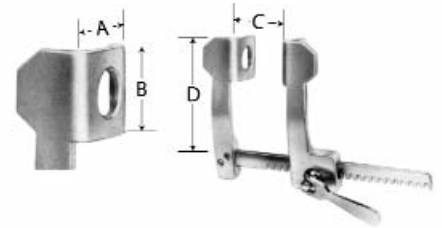
 Artikel-Nr.
 Cat. No.

COOLEY

06-02-836

A	B	C	D
28 mm	32 mm	120 mm	140 mm

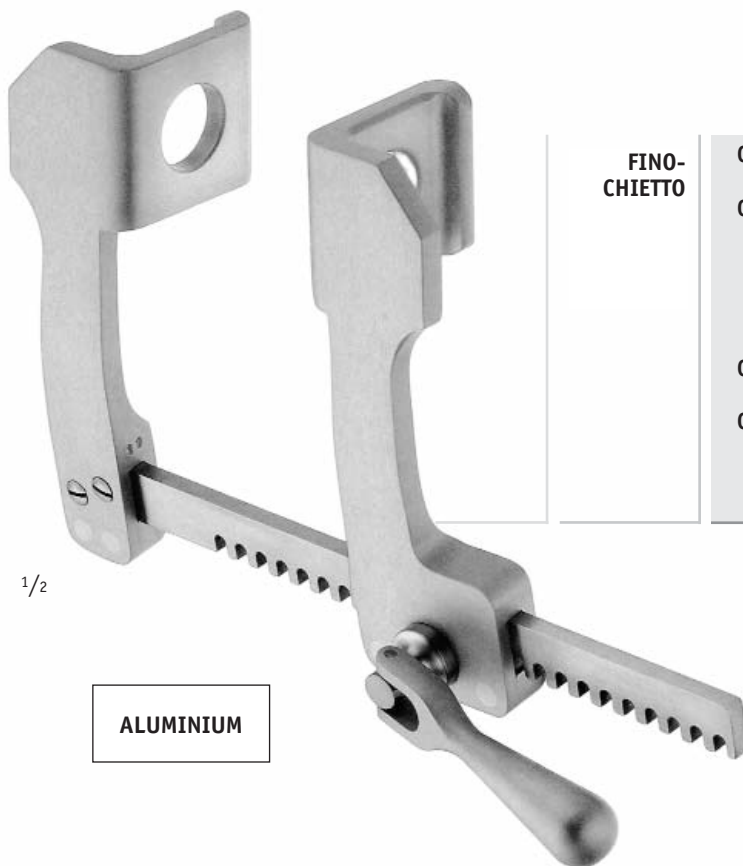

1/2

ALUMINIUM

FINO-
CHIETTO

06-03-041

28 mm 30 mm 143 mm 80 mm

06-03-042

31 mm 45 mm 210 mm 110 mm

 für Kinder
 for children · pour enfants · para niños · per bambini

06-03-043

42 mm 62 mm 245 mm 145 mm

06-03-044

74 mm 64 mm 250 mm 145 mm

 für Erwachsene
 for adults · pour adultes · para adultos · per adulti

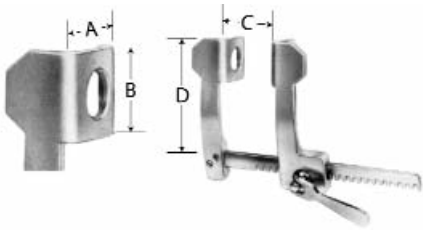

Artikel-Nr.
 Cat. No.

A B C D

06-52-834

30 mm 30 mm 90 mm 70 mm

HAIGHT

für Kinder
 for children · pour enfants · para niños · per bambini

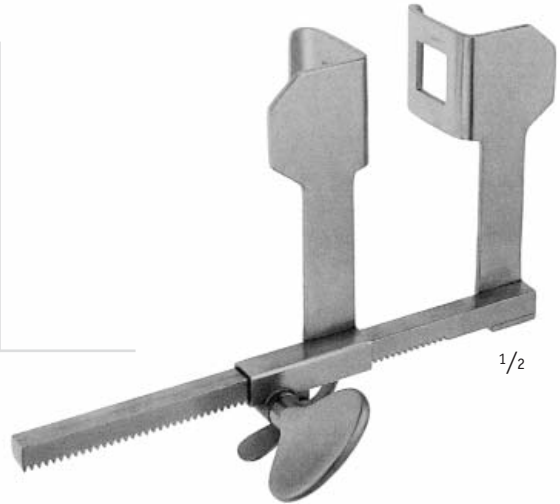

1/2

06-02-835

30 mm 30 mm 115 mm 90 mm

HAIGHT

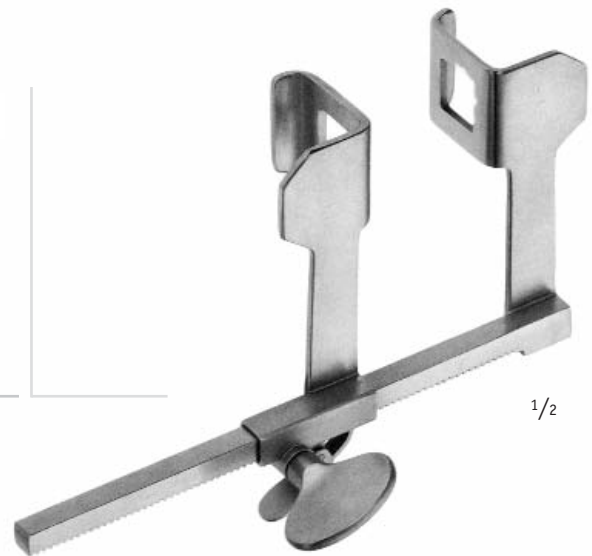

1/2

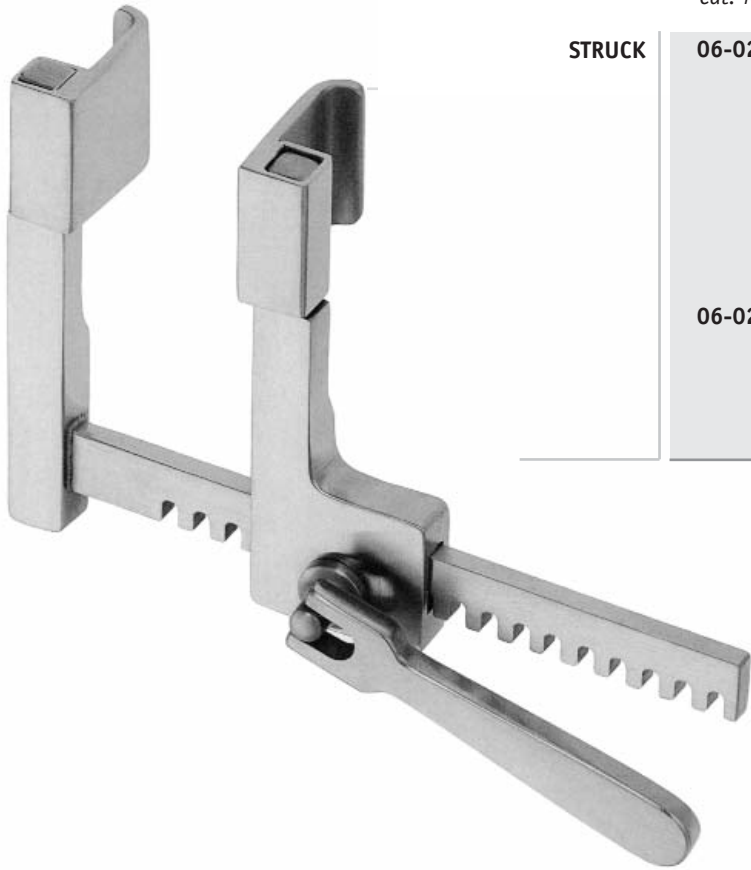
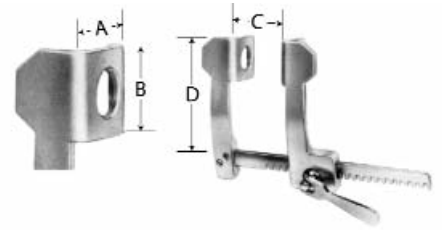
 Artikel-Nr.
 Cat. No.

C D

STRUCK
06-02-852

70 mm 64 mm

für Kleinkinder mit 2 Paar Valven
 for children with 2 pairs of blades
 pour enfants avec 2 paires de valves
 para niños con 2 pares de valvas
 per bambini con 2 paio di valve
06-02-857 - 06-02-858

06-02-853

70 mm 64 mm

Sperrer allein
 retractor only · écarteur seul ·
 separador solo · divaricatore solo

1/1

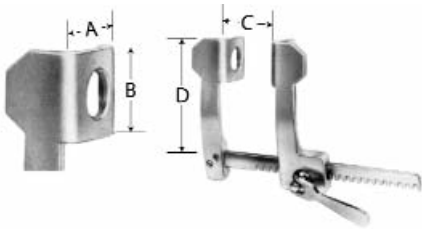

Artikel-Nr.
 Cat. No.

A B

06-02-854	10 mm 10 mm	STRUCK	
	<i>Paar Valven</i> <i>pair of blades · paire de valves</i> <i>par de valvas · paio di valve</i>		



06-02-855	10 mm 15 mm	STRUCK	
	<i>Paar Valven</i> <i>pair of blades · paire de valves</i> <i>par de valvas · paio di valve</i>		



06-02-856	10 mm 20 mm	STRUCK	
	<i>Paar Valven</i> <i>pair of blades · paire de valves</i> <i>par de valvas · paio di valve</i>		



06-02-857	15 mm 20 mm	STRUCK	
	<i>Paar Valven</i> <i>pair of blades · paire de valves</i> <i>par de valvas · paio di valve</i>		



06-02-858	20 mm 20 mm	STRUCK	
	<i>Paar Valven</i> <i>pair of blades · paire de valves</i> <i>par de valvas · paio di valve</i>		

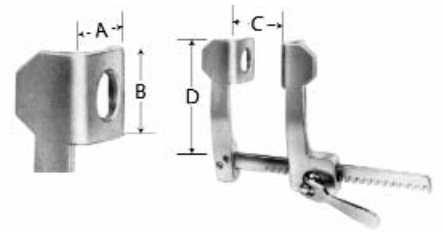

 Artikel-Nr.
 Cat. No.

A B C D

**FINO-
CHIETTO
BURFORD**
06-52-813

33/43 mm 43 mm 135 mm 118 mm

 für Kinder mit 2 Paar Valven
 for children with 2 pairs of blades
 pour enfants avec 2 paires de valves
 para niños con 2 pares de valvas
 per bambini con 2 paio di valve
06-52-814 - 06-52-815
06-52-814

33 mm 43 mm

06-52-815

43 mm 43 mm

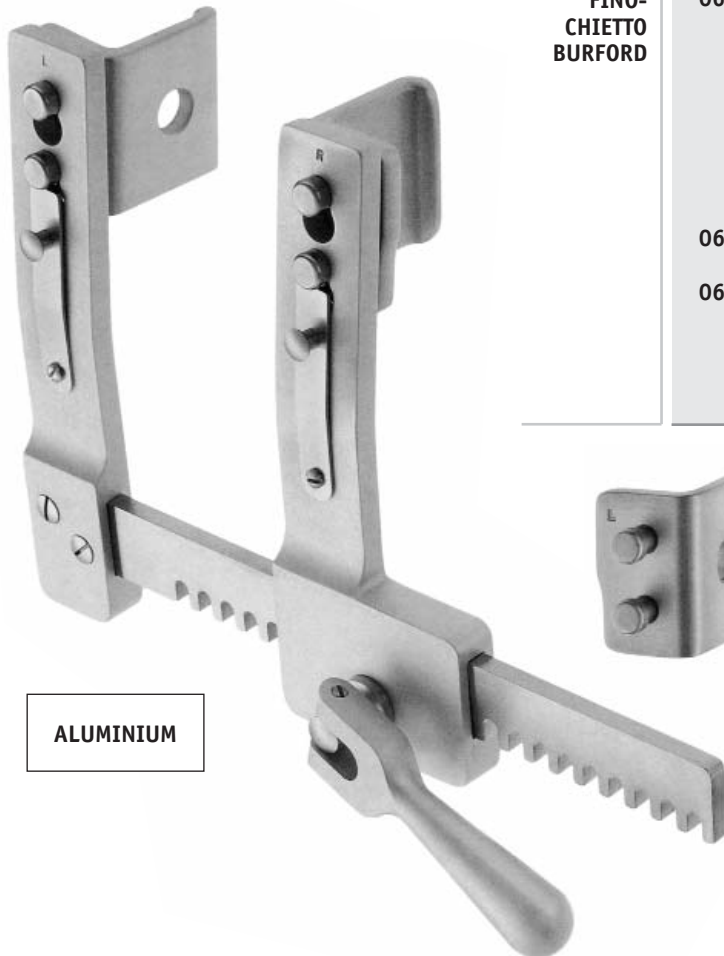
 Paar Valven
 pair of blades · paire de valves
 par de valvas · paio di valve

1/2

ALUMINIUM

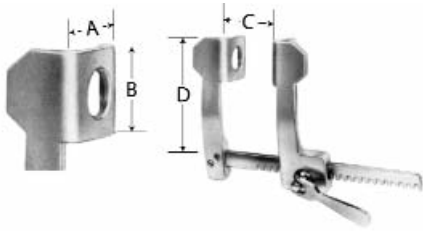

Artikel-Nr.
 Cat. No.

A B C D

06-02-851

22 mm 45 mm 150 mm 110 mm

für Kinder
 for children · pour enfants · para niños · per bambini

06-02-850

34 mm 51 mm 200 mm 145 mm

06-52-852

34 mm 100 mm 180 mm 180 mm

für Erwachsene
 for adults · pour adultes · para adultos · per adulti

06-52-853

34 mm 100 mm 180 mm 180 mm

für Erwachsene mit Fadenfänger
 for adults with suture separator
 pour adultes avec chasseur de suture
 para adultos con separador de la sutura
 per adulti con il separatore della sutura

06-52-854

34 mm 115 mm 230 mm 205 mm

für Erwachsene extra groß
 for adults extra large
 pour adultes extra-grand
 para adultos extragrande
 per adulti grande supplementare

COOLEY



ALUMINIUM

1/2

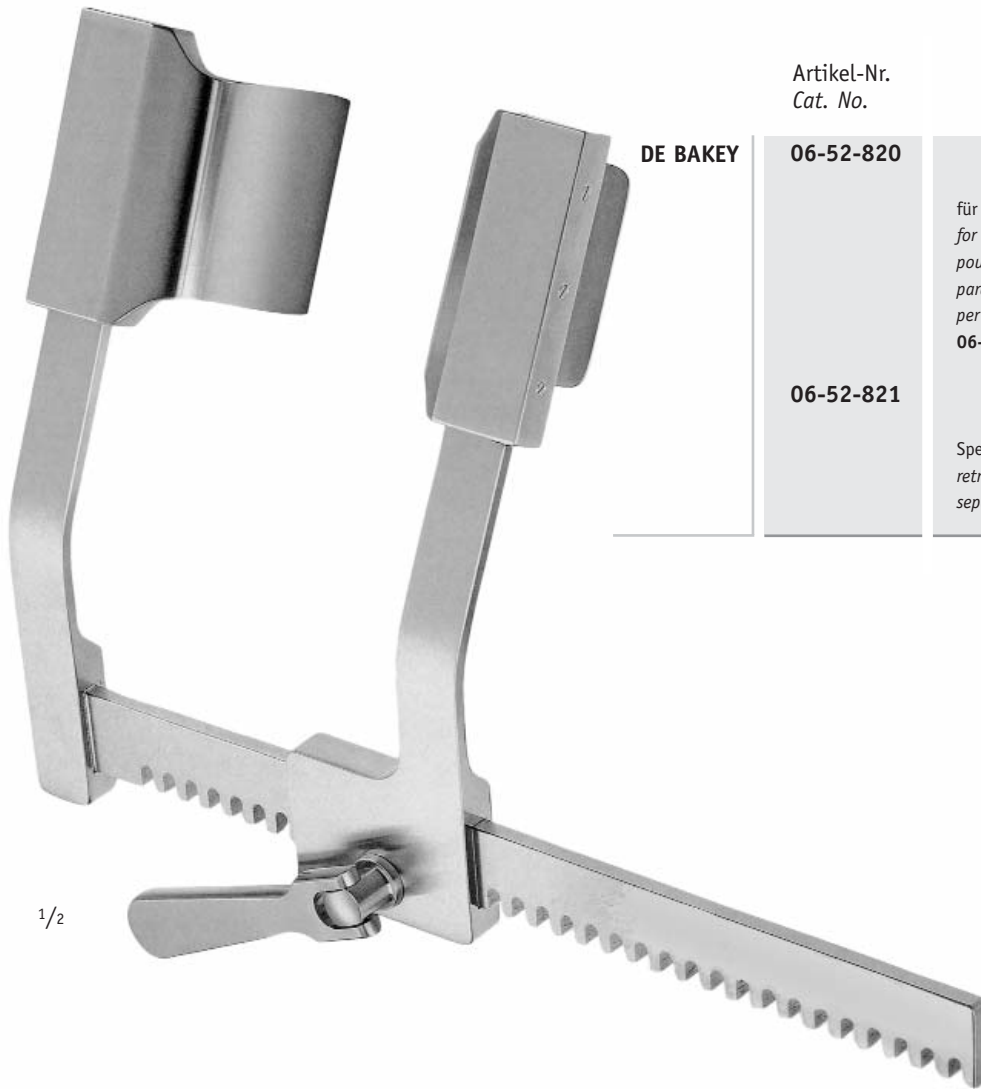
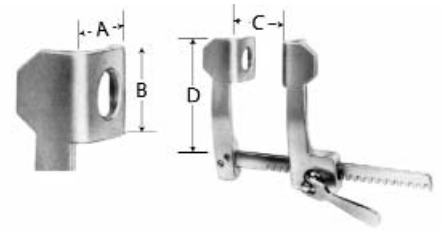
DE BAKEY

 Artikel-Nr.
 Cat. No.

C D

06-52-820

150 mm 120 mm

für Kinder mit 3 Paar Valven
 for children with 3 pairs of blades
 pour enfants avec 3 paires de valves
 para niños con 3 pares de valvas
 per bambini con 3 paio di valve
06-52-822 - 06-52-824

06-52-821

150 mm 120 mm

Sperrer allein
 retractor only · écarteur seul
 separador solo · divaricatore solo

1/2

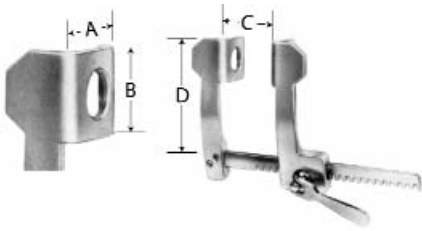

Artikel-Nr.
 Cat. No.

A B

06-52-822

60 mm 60 mm

DE BAKEY

Paar Valven
 pair of blades · paire de valves
 par de valvas · paio di valve



06-52-823

50 mm 80 mm

DE BAKEY

Paar Valven
 pair of blades · paire de valves
 par de valvas · paio di valve



06-52-824

40 mm 100 mm

DE BAKEY

Paar Valven
 pair of blades · paire de valves
 par de valvas · paio di valve



06-52-825

80 mm 60 mm

DE BAKEY

Paar Valven
 pair of blades · paire de valves
 par de valvas · paio di valve



06-52-826

50 mm 66 mm

DE BAKEY

Paar Valven
 pair of blades · paire de valves
 par de valvas · paio di valve

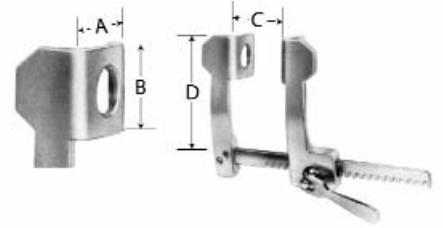

 Artikel-Nr.
 Cat. No.

TUFFIER
06-02-847

A B C D

32 mm 19 mm 145 mm 90 mm

für Kinder

for children · pour enfants · para niños · per bambini

1/2

TUFFIER
06-02-800

50 mm 45 mm 165 mm 110 mm

1/2

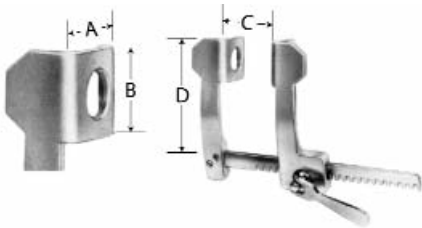

Artikel-Nr.
 Cat. No.

A B C D

06-02-802	40 mm	40 mm	165 mm	110 mm
06-02-803	45 mm	65 mm	200 mm	140 mm
06-02-804	70 mm	65 mm	250 mm	140 mm
06-52-805	70 mm	65 mm	300 mm	140 mm

für Erwachsene
 for adults · pour adultes · para adultos · per adulti

**FINO-
 CHIETTO**

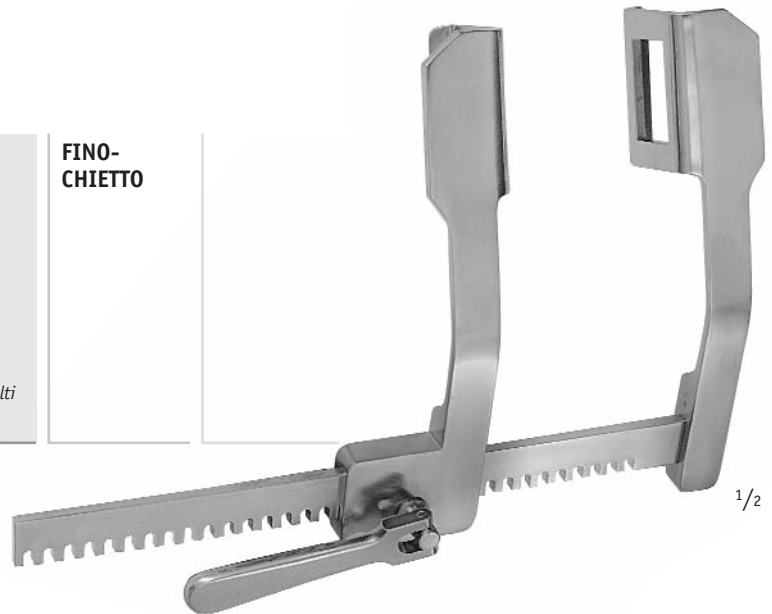

1/2

02-72-630

48 mm 45 mm 170 mm 110 mm

Laminectomie-Spreizer
 Laminectomy Spreader
 Ecarteur pour laminectomie
 Separador para laminectomía
 Divaricatori per laminectomia

BADGLEY

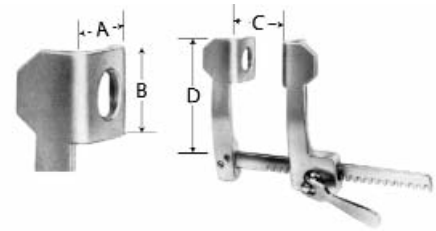

1/2

 Artikel-Nr.
 Cat. No.

A B C D

**FINO-
CHIETTO**
06-52-827

30 mm 45 mm 145 mm 110 mm

 für Erwachsene kleines Modell
for adults small model
pour adultes petit
para adultos, modelo pequeño
per adulti, modello piccolo
06-52-828

42 mm 62 mm 180 mm 145 mm

 für Erwachsene
for adults · pour adultes · para adultos · per adulti
06-52-829

42 mm 62 mm 180 mm 145 mm

 für Erwachsene mit Fadenfänger
for adults with suture separator
pour adultes avec chasseur de suture
para adultos con separador de la sutura
per adulti con il separatore della sutura
06-52-830

80 mm 65 mm 180 mm 145 mm

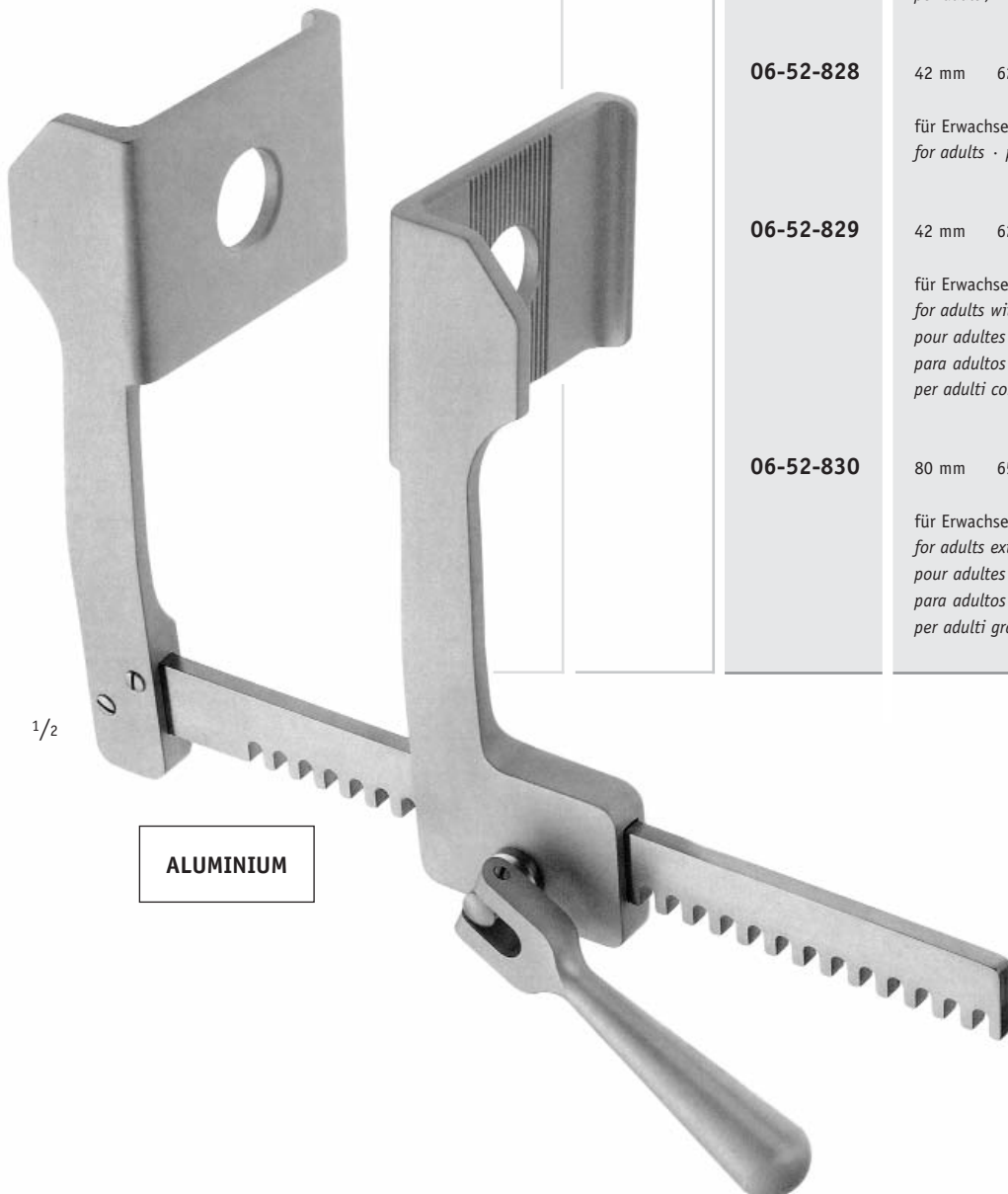
 für Erwachsene extra groß
for adults extra large
pour adultes extra-grand
para adultos extragrande
per adulti grande supplementare

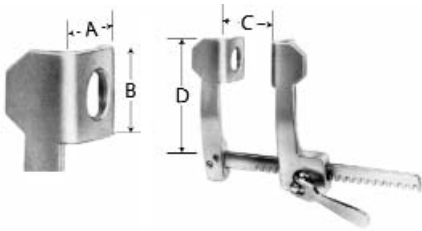
ALUMINIUM



Artikel-Nr.
 Cat. No.

A B C D

06-52-835 43/63 mm 61 mm 200 mm 200 mm

06-52-836 43/63 mm 61 mm 260 mm 200 mm

06-52-837 43/63 mm 61 mm 300 mm 200 mm

für Erwachsene mit 2 Paar Valven
 for adults with 2 pairs of blades
 pour adultes avec 2 paires de valves
 para adultos con 2 pares de valvas
 per adulti con 2 paio di valve
06-52-838 - 06-52-839

06-52-838 43 mm 61 mm

06-52-839 63 mm 61 mm

Paar Valven
 pair of blades · paire de valves
 par de valvas · paio di valve

**FINO-
 CHIETTO
 BURFORD**

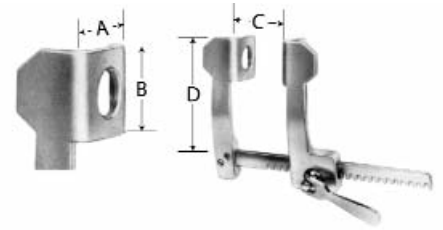

ALUMINIUM

 Artikel-Nr.
 Cat. No.

C D

DUBOST
06-52-840

160 mm 160 mm

für Erwachsene mit 3 Paar Valven
 for adults with 3 pairs of blades
 pour adultes avec 3 paires de valves
 para adultos con 3 pares de valvas
 per adulti con 3 paio di valve
06-52-842 - 06-52-844

06-52-841

160 mm 160 mm

Sperrer allein
 retractor only · écarteur seul ·
 separador solo · divaricatore solo



1/2

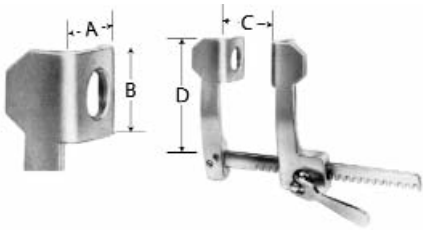

Artikel-Nr.
 Cat. No.

A B

06-52-842

40 mm 100 mm

DUBOST

Paar Valven
pair of blades · paire de valves
par de valvas · paio di valve



06-52-843

50 mm 100 mm

DUBOST

Paar Valven
pair of blades · paire de valves
par de valvas · paio di valve



06-52-844

60 mm 100 mm

DUBOST

Paar Valven
pair of blades · paire de valves
par de valvas · paio di valve

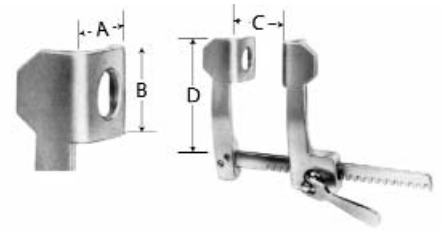

 Artikel-Nr.
 Cat. No.

C D

DE BAKEY
06-02-808

150 mm 180 mm

für Erwachsene mit 3 Paar Valven
 for adults with 3 pairs of blades
 pour adultes avec 3 paires de valves
 para adultos con 3 pares de valvas
 per adulti con 3 paio di valve

06-02-810, 06-02-811 & 06-02-812
06-02-809

150 mm 180 mm

Sperrer allein
 retractor only · écarteur seul
 separador solo · divaricatore solo



1/2

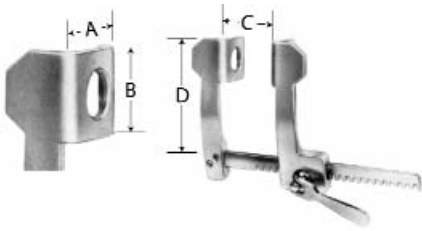

Artikel-Nr.
 Cat. No.

A B

06-02-810

30 mm 30 mm

DE BAKEY

Paar Valven
 pair of blades · paire de valves
 par de valvas · paio di valve



06-02-811

40 mm 40 mm

DE BAKEY

Paar Valven
 pair of blades · paire de valves
 par de valvas · paio di valve



06-02-812

50 mm 50 mm

DE BAKEY

Paar Valven
 pair of blades · paire de valves
 par de valvas · paio di valve



06-02-813

66 mm 66 mm

DE BAKEY

Paar Valven
 pair of blades · paire de valves
 par de valvas · paio di valve

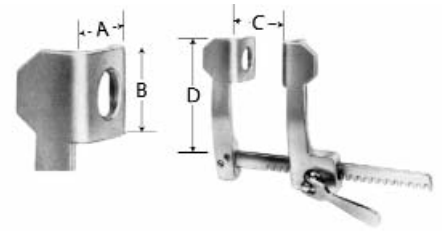

 Artikel-Nr.
 Cat. No.

C D

DE BAKEY
06-02-814

200 mm 225 mm

für Erwachsene mit 3 Paar Valven
 for adults with 3 pairs of blades
 pour adultes avec 3 paires de valves
 para adultos con 3 pares de valvas
 per adulti con 3 paio di valve
06-02-816 - 06-02-818

06-02-815

200 mm 225 mm

Sperrer allein
 retractor only · écarteur seul
 separador solo · divaricatore solo

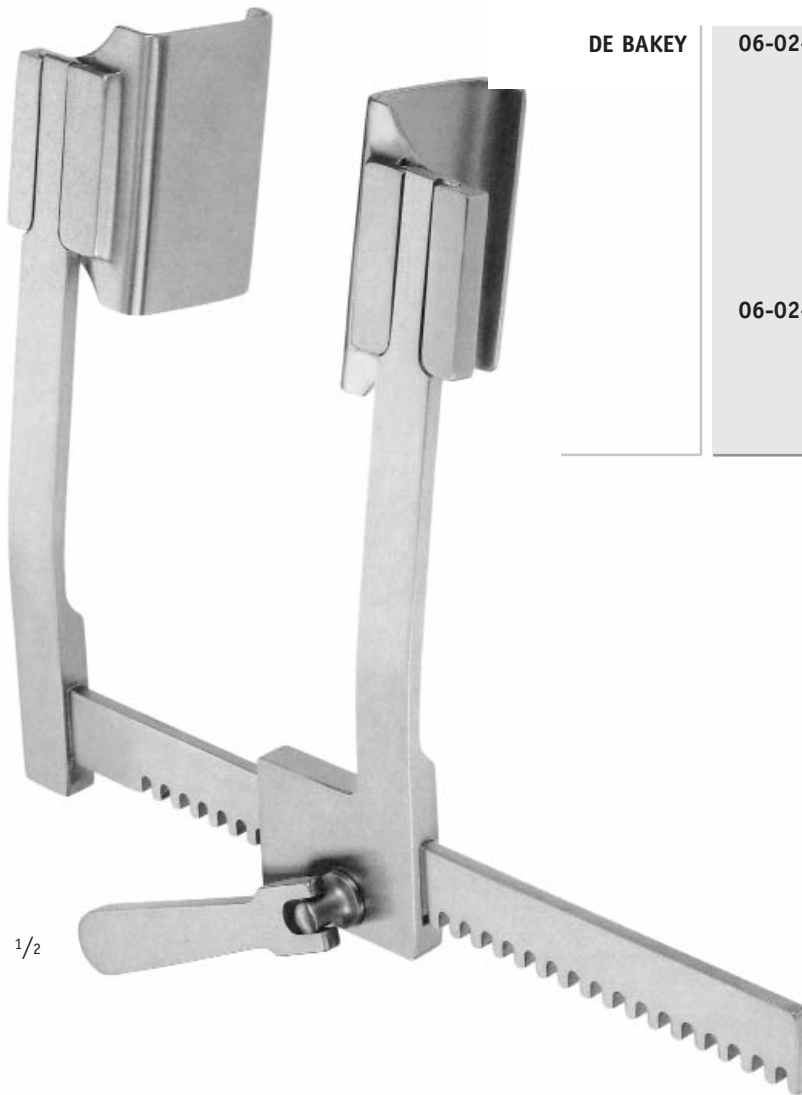

1/2

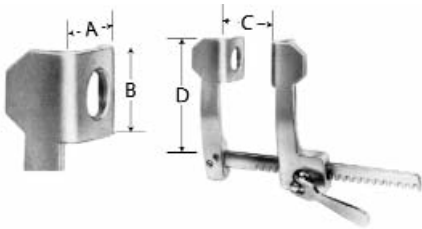

Artikel-Nr.
 Cat. No.

A B

06-02-818

40 mm 100 mm

DE BAKEY

Paar Valven
 pair of blades · paire de valves
 par de valvas · paio di valve



06-02-817

50 mm 80 mm

DE BAKEY

Paar Valven
 pair of blades · paire de valves
 par de valvas · paio di valve



06-02-816

60 mm 60 mm

DE BAKEY

Paar Valven
 pair of blades · paire de valves
 par de valvas · paio di valve



06-02-813

66 mm 66 mm

DE BAKEY

Paar Valven
 pair of blades · paire de valves
 par de valvas · paio di valve



06-02-819

80 mm 60 mm

DE BAKEY

Paar Valven
 pair of blades · paire de valves
 par de valvas · paio di valve



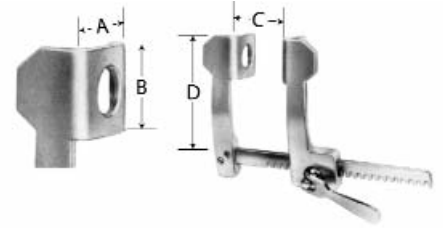

 Artikel-Nr.
 Cat. No.

C D

**FINO-
CHIETTO
BURFORD**
06-02-805

220 mm 220 mm

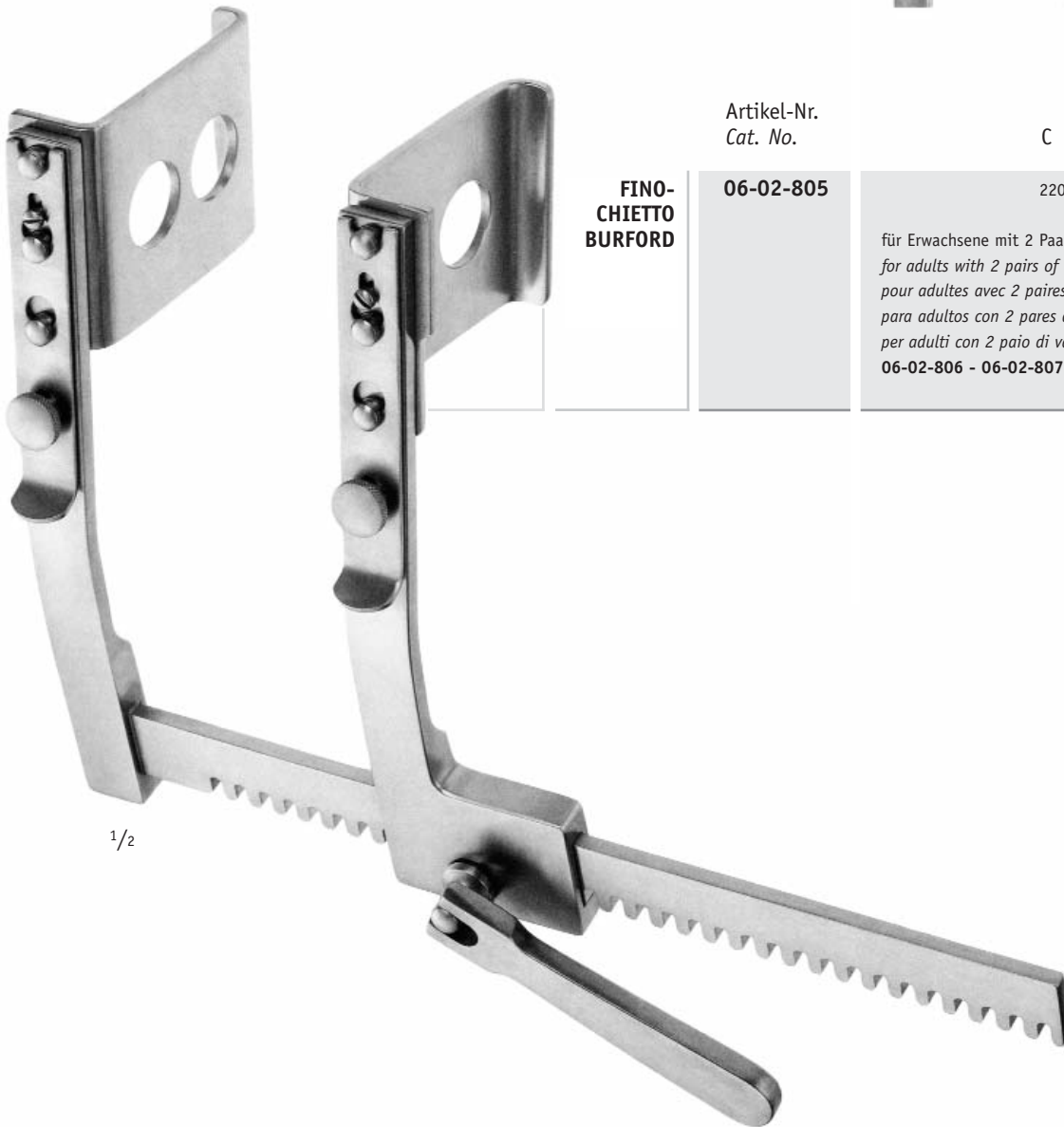
für Erwachsene mit 2 Paar Valven
 for adults with 2 pairs of blades
 pour adultes avec 2 paires de valves
 para adultos con 2 pares de valvas
 per adulti con 2 paio di valve
06-02-806 - 06-02-807



1/2

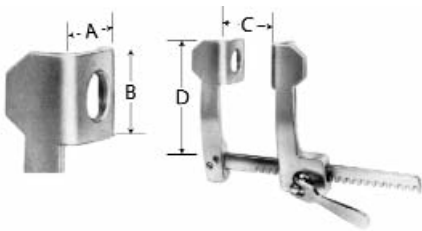

Artikel-Nr.
 Cat. No.

A B

06-02-806

40 mm 67 mm

Paar Valven
 pair of blades · paire de valves
 par de valvas · paio di valve

**FINO-
 CHIETTO
 BURFORD**



06-02-807

80 mm 67 mm

Paar Valven
 pair of blades · paire de valves
 par de valvas · paio di valve

**FINO-
 CHIETTO
 BURFORD**



06-52-808

30 mm 80 mm

Paar Valven
 pair of blades · paire de valves
 par de valvas · paio di valve

**FINO-
 CHIETTO
 BURFORD**



06-52-809

25,5 mm 80 mm

Paar Valven
 pair of blades · paire de valves
 par de valvas · paio di valve

**FINO-
 CHIETTO
 BURFORD**

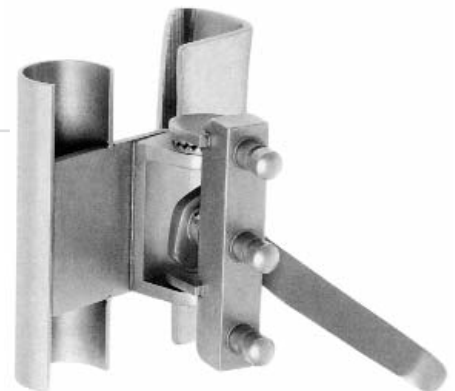

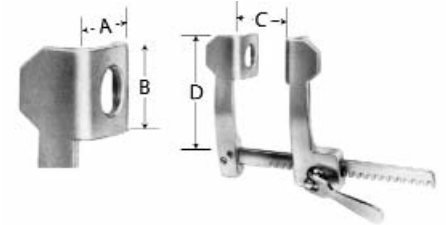

 Artikel-Nr.
 Cat. No.

MERCEDES
06-02-820

 mit 2 Paar Valven
 with 2 pairs of blades
 avec 2 paires de valves
 con 2 pares de valvas
 con 2 paio di valve
06-02-822 - 06-02-823
06-02-821

 Sperrer allein
 retractor only · écarteur seul
 separador solo · divaricatore solo

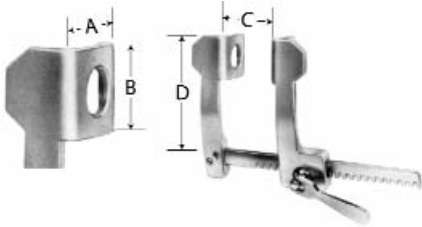
1/2



Artikel-Nr.
 Cat. No.

A B

06-02-822

48 mm 68 mm

MERCEDES

Paar Valven
pair of blades · paire de valves
par de valvas · paio di valve



06-02-823

70 mm 75 mm

MERCEDES

Paar Valven
pair of blades · paire de valves
par de valvas · paio di valve

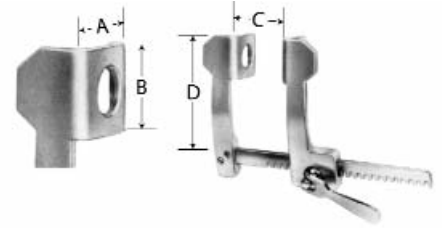

 Artikel-Nr.
 Cat. No.

MORSE
06-02-845

A	B	C	D	E
20 mm	20 mm	160 mm	120 mm	50 mm

für Kinder, mit 2 Paar beweglichen Valven,
 Abstand der Valven 50 mm
for children, with 2 pairs of swivel blades 50 mm apart
pour enfants, avec 2 paires de valves volantes,
50 mm distance entre les valves ·
para niños, con 2 pares de valvas ágiles,
distancia de las valvas 50 mm ·
per bambini, con 2 paio di valve movente,
distanza di la valve 50 mm

06-02-846

20 mm	28 mm	200 mm	150 mm	72 mm
-------	-------	--------	--------	-------

für Erwachsene, mit 2 Paar beweglichen Valven,
 Abstand der Valven 72 mm ·
for adults, with 2 pairs of swivel blades 72 mm apart
pour adultes, avec 2 paires de valves volantes,
72 mm distance entre les valves ·
para adultos, con 2 pares de valvas ágiles,
distancia de las valvas 72 mm ·
per adulti, con 2 paio di valve movente,
distanza di la valve 72 mm

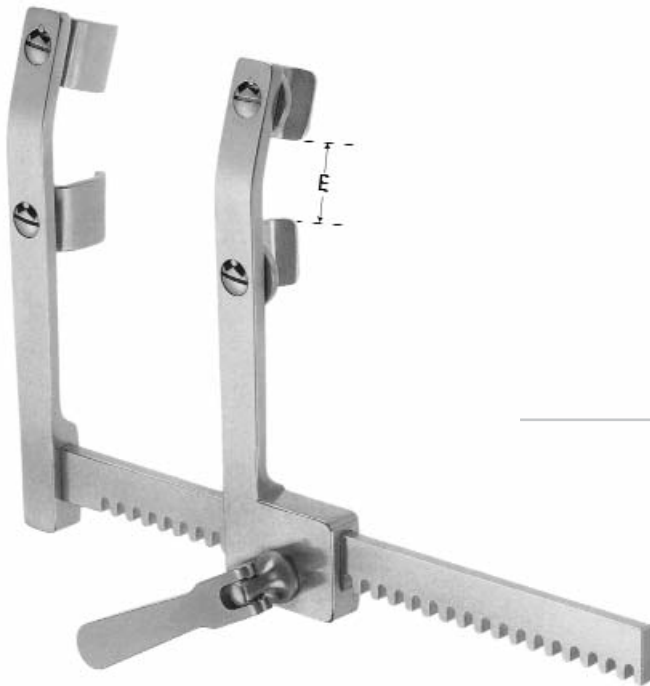

1/2

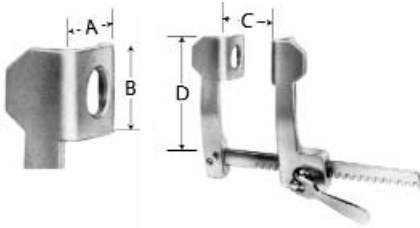

Artikel-Nr.
 Cat. No.

A B C D E

06-52-847

17 mm 22 mm 160 mm 120 mm 50 mm

für Kinder, mit 2 Paar beweglichen Valven,
 Abstand der Valven 50 mm
for children, with 2 pairs of swivel blades 50 mm apart
pour enfants, avec 2 paires de valves volantes,
50 mm distance entre les valves ·
para niños, con 2 pares de valvas ágiles,
distancia de las valvas 50 mm ·
per bambini, con 2 paio di valve movente,
distanza di la valve 50 mm

06-52-848

40 mm 20 mm 155 mm 175 mm 65 mm

für Erwachsene, mit 2 Paar beweglichen Valven,
 Abstand der Valven 65 mm ·
for adults, with 2 pairs of swivel blades 65 mm apart
pour adultes, avec 2 paires de valves volantes,
65 mm distance entre les valves ·
para adultos, con 2 pares de valvas ágiles,
distancia de las valvas 65 mm ·
per adulti, con 2 paio di valve movente,
distanza di la valve 65 mm

**MORSE-
 FAVOROLO**

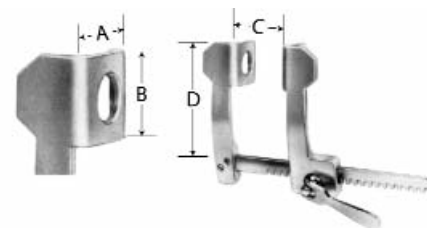

ALUMINIUM

 Artikel-Nr.
 Cat. No.

MORSE

06-52-849

A B C D E

20 mm 20 mm 155 mm 120 mm 50 mm

für Kinder, mit 2 Paar beweglichen Valven,
 Abstand der Valven 50 mm ·
for children, with 2 pairs of swivel blades 50 mm apart
pour enfants, avec 2 paires de valves volantes,
50 mm distance entre les valves ·
para niños, con 2 pares de valvas ágiles,
distancia de las valvas 50 mm ·
per bambini, con 2 paio di valve movente,
distanza di la valve 50 mm

06-52-850

20 mm 28 mm 210 mm 155 mm 155 mm

für Erwachsene, mit 2 Paar beweglichen Valven,
 Abstand der Valven 72 mm ·
for adults, with 2 pairs of swivel blades 72 mm apart
pour adultes, avec 2 paires de valves volantes,
72 mm distance entre les valves ·
para adultos, con 2 pares de valvas ágiles,
distancia de las valvas 72 mm ·
per adulti, con 2 paio di valve movente,
distanza di la valve 72 mm

06-52-851

30 mm 35 mm 200 mm 195 mm 42 mm

für Erwachsene, mit 3 Paar beweglichen Valven,
 Abstand der Valven 42 mm ·
for adults, with 3 pairs of swivel blades 42 mm apart
pour adultes, avec 3 paires de valves volantes,
42 mm distance entre les valves ·
para adultos, con 3 pares de valvas ágiles,
distancia de las valvas 42 mm ·
per adulti, con 3 paio di valve movente,
distanza di la valve 42 mm

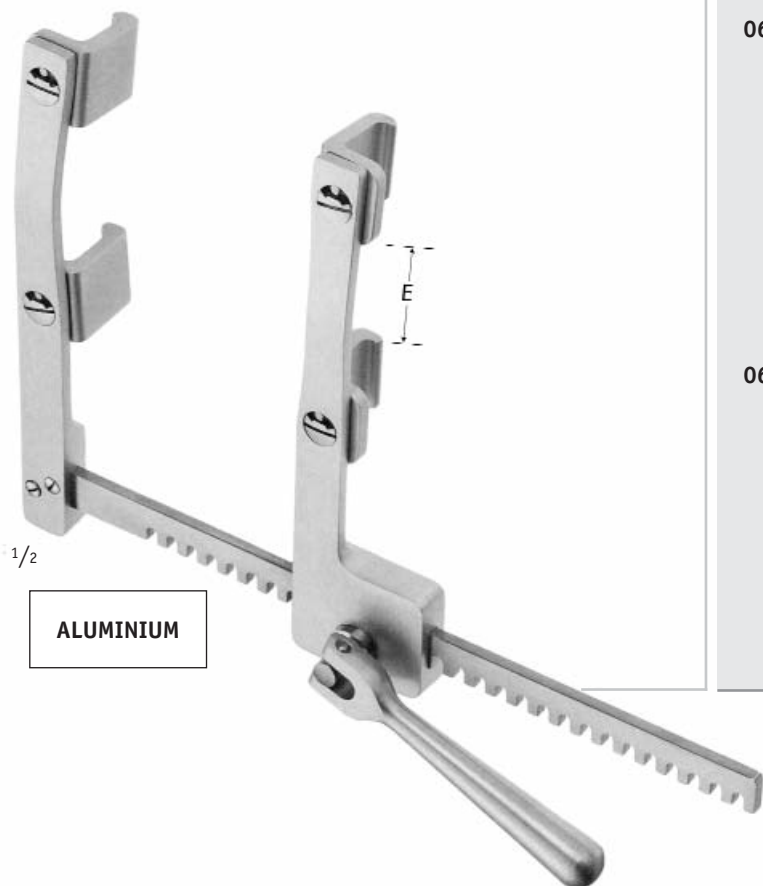

ALUMINIUM

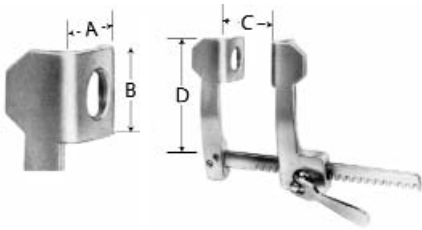

Artikel-Nr.
 Cat. No.

A B C D E

06-52-855

25 mm 19 mm 127 mm 114 mm

ANKENEY

für Kinder, mit 2 Paar beweglichen Valven
 for children, with 2 pairs of swivel blades
 pour enfants, avec 2 paires de valves volantes
 para niños, con 2 pares de valvas ágiles
 per bambini, con 2 paio di valve movente



1/2

ALUMINIUM

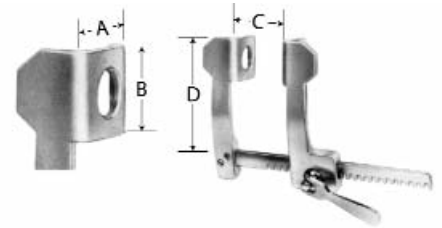
 Artikel-Nr.
 Cat. No.

A B C D

ANKENEY
06-52-856

32 mm 35 mm 178 mm 292 mm

für Erwachsene, mit 3 Paar beweglichen Valven
for adults, with 3 pairs of swivel blades
pour adultes, avec 3 paires de valves volantes
para adultos, con 3 pares de valvas ágiles
per adulti, con 3 paio di valve movente

06-52-857

52 mm 35 mm

extra tiefe Valven (6 Stück)
extra deep blades (6 pieces)
lames extra basses (6 pièces)
valvas adicionales profundas (6 piezas)
extra valve profonda (6 pezzi)

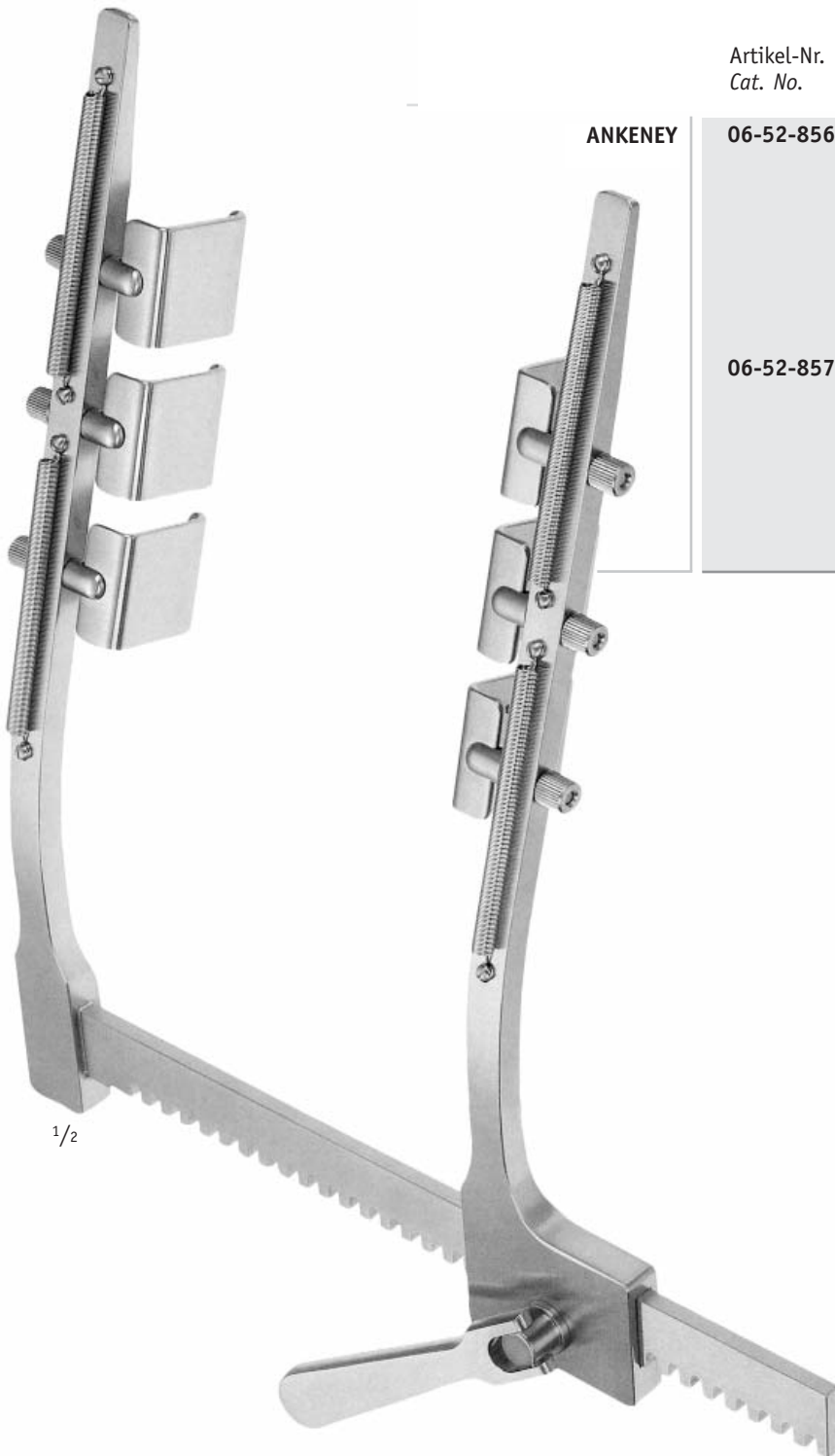

1/2

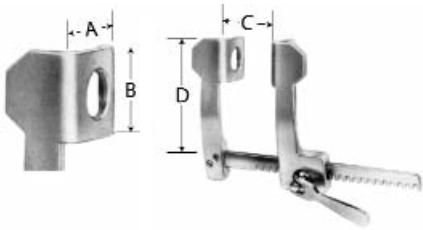

Artikel-Nr.
 Cat. No.

A	B	C	D
20 mm	25 mm	105 mm	90 mm

02-22-512

HERTZLER

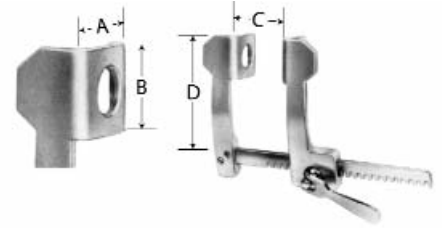

1/2

 Artikel-Nr.
 Cat. No.

C D

I.M.A.

06-03-060

215 mm 140 mm

Mammaria Sperrer, komplett, bestehend aus:
 mammaria retractor, complete, consisting of:
 Ecarteur à mammaria, complet, composé de:
 Separador mammaria, completo, compuesto de:
 Divaricatori per mammaria, completo, composto de:
06-03-061 - 06-03-064

06-03-061

215 mm 140 mm

Sperrer allein
 retractor only · écarteur seul
 separador solo · divaricatore solo



1/2

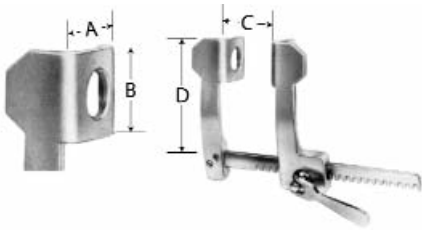

Artikel-Nr.
 Cat. No.

A B

06-03-062

30 mm 50 mm

I.M.A.

Mammariablatt komplett,
 mit Aufnahmeblatt links und rechts ·
Mammaria blade complete,
with holding blades left and right ·
Mammaria valves complètes,
avec valves droites et gauches ·
Mammaria valvas completo,
con valvas izquierdas y derechas ·
Mammaria valve completo,
con valve sinistra e destra

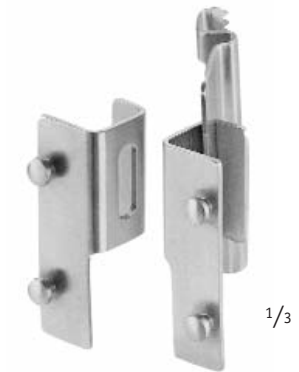

1/3

06-03-063

30 mm 100 mm

I.M.A.

Sternumblätter, Paar
sternum blades, pair · valves à sternum, paire ·
sternum valvas, pareja · sternum valve, coppia



1/3

06-03-064

40 mm 100 mm

I.M.A.

Sternumblätter, Paar
sternum blades, pair · valves à sternum, paire ·
sternum valvas, pareja · sternum valve, coppia

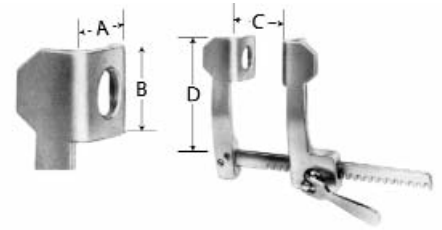

1/3

 Artikel-Nr.
 Cat. No.

A B C D

BUGGE
06-52-845

40 mm 100 mm 110 mm

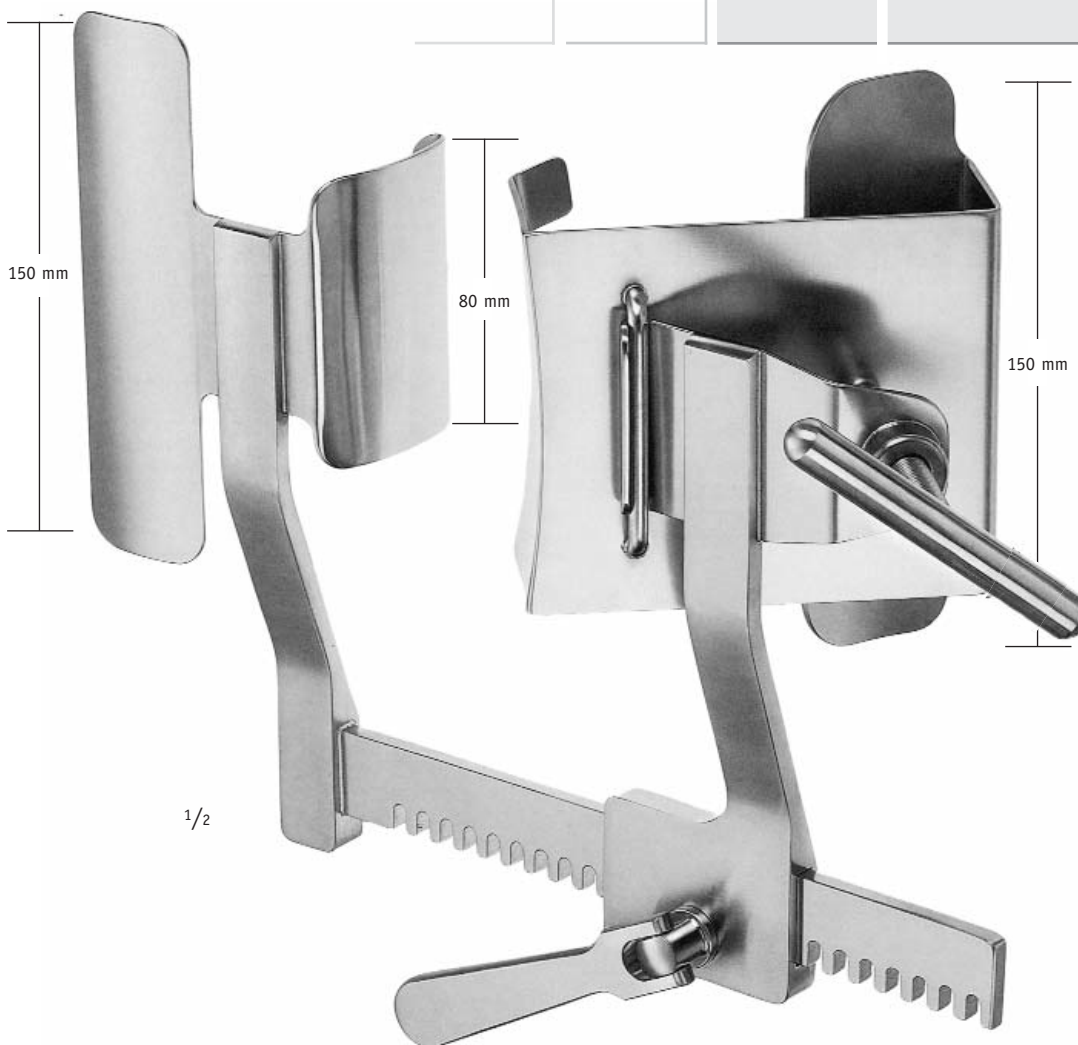
 Mammaria Sperrer, komplett
 Mammaria retractor, complete
 Ecarteur à mammaria, complet
 Separador mammaria, completo
 Divaricatori per mammaria, completo

1/2





1/2

Artikel-Nr.
 Cat. No.

Gesamtlänge
 Total length

06-02-840

200 mm / 8"

SELLORS

Rippensperrer und -kontraktor mit drehbaren Klauen
Rib spreader and contractor with swivel blades
Ecarteur et rapprocheur pour costaux avec valves rotatives
Separador y contractor costal con garras girables
Divaricatore ed approssimatore costale con valve orientabili

06-52-831

180 mm / 7"

LEMMON

für Erwachsene
for adults
pour adultes
para adultos
per adulti



1/2

06-52-832

140 mm / 5 1/2"

LEMMON

für Kinder
for children
pour enfants
para niños
per bambini



**BAILEY-
BABY**

 Artikel-Nr.
 Cat. No.

06-02-844

 Gesamtlänge
 Total length

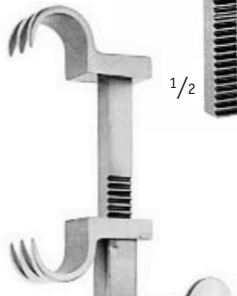
155 mm / 6"

 für Kinder
 for children
 pour enfants
 para niños
 per bambini

BAILEY
06-02-841

200 mm / 8"

 für Kinder
 for children
 pour enfants
 para niños
 per bambini

**BAILEY-
GIBBON**
06-02-842

200 mm / 8"

 für Erwachsene
 for adults
 pour adultes
 para adultos
 per adulti

1/2



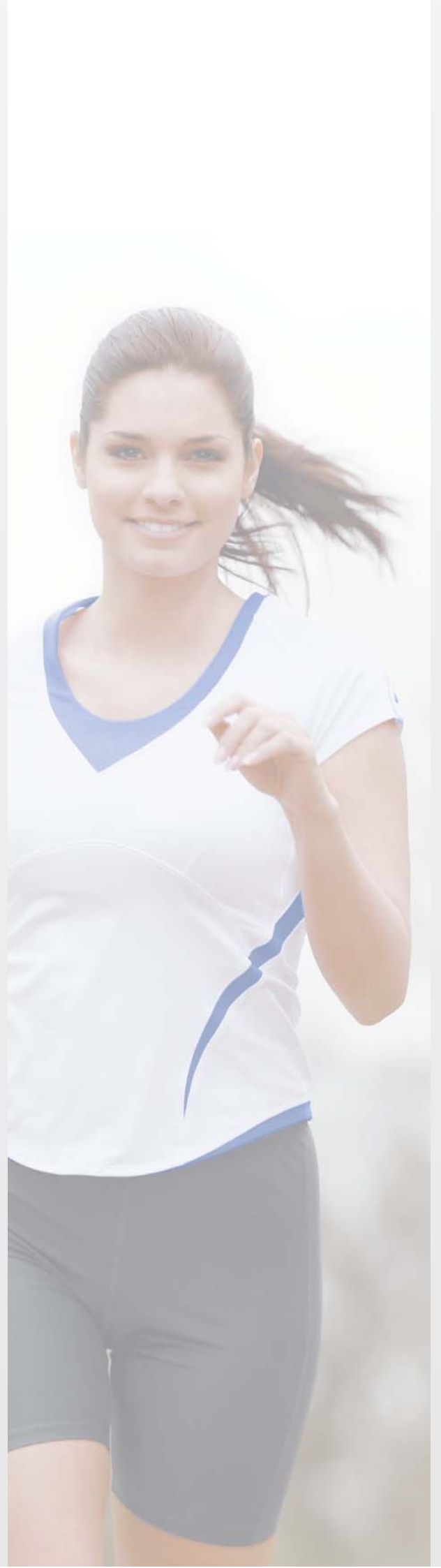

Bulldogklemmen, Gefäßclips
Bulldog Clamps, Vessel Clips · Clamps Bulldog, Clips vasculaires
Clamps Bulldog, Clips vasculares · Pinze Bulldog, Clips vascolari

// 01

Atraumatische Gefäßklemmen
Atraumatic Vascular Clamps · Pincés vasculaires atraumatiques
Pinzas vasculares atraumáticas · Pinze vascolari atraumatiche

// 02

Atraumatische Pinzetten
Atraumatic Tissue Forceps · Pincés atraumatiques
Pinzas atraumáticas · Pinze atraumatiche

// 03

Rippensperrer
Rib Spreaders · Ecarteurs pour costaux
Separadores costales · Divaricatori costali

// 04

Atrium, Aorta-Instrumente
Atrium-, Aortic Instruments · Instruments pour l'oreillette et l'aorte
Instrumentos para el atrium y la aorta · Strumenti per atrio e aorta

// 05

Wundhaken, Wundspreizer
Retractors · Ecarteurs
Separadores · Divaricatori

// 06

Sonden, Dilatationsinstrumente
Probes, Instruments for dilatation · Sondes, Instruments pour la dilatation
Sondas, Instrumentos para la dilatación · Sonda, Strumenti a dilatazione

// 07

Mikro-Instrumente
Micro Instruments · Micro instruments
Instrumentos para microcirugía · strumenti per microchirurgia

// 08

Allgemeinchirurgische Instrumente
General surgery instruments · Instruments pour la chirurgie générale
Instrumentos para la cirugía general · Strumenti per chirurgia generale





// 09

Orthopädische Instrumente
Orthopaedic Instruments · Instruments pour l'orthopédie
Instrumentos para ortopedia · Strumenti per ortopedia

// 10

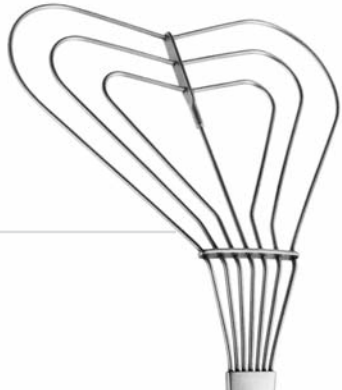

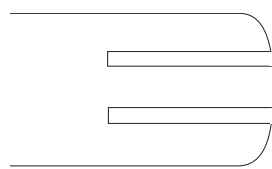

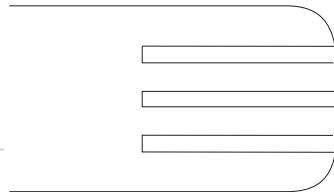
Artikel-Nr. Cat. No.	Gesamtlänge Total length			
02-20-561	300 mm / 12" 137 mm			
02-70-560	260 mm / 10 ¹ / ₄ " 132 mm			
02-70-561	280 mm / 11" 30 mm	ALLISON		
02-20-559	300 mm / 12" 40 mm	ALLISON		
02-20-560	320 mm / 12 ³ / ₄ " 54 mm	ALLISON		
02-70-562	320 mm / 12 ³ / ₄ " 65 mm	ALLISON		
02-70-563	250 mm / 10" 20 mm Fig. 1	SEMB		
02-70-564	250 mm / 10" 24 mm Fig. 2	SEMB		



COOLEY

 Artikel-Nr.
 Cat. No.

06-02-860

 Gesamtlänge
 Total length

 250 mm / 9³/₄"
 48 x 48 mm

 rechts
 right
 droite
 derecho
 destro

COOLEY

06-02-861

 250 mm / 9³/₄"
 48 x 48 mm

 rechts, gerieft
 right, serrated
 droite, cannelé
 derecho, estriado
 destro, seghettato

COOLEY

06-02-862

 275 mm / 10³/₄"
 30 x 48 mm

 links
 left
 à gauche
 izquierdo
 sinistro

1/3

Artikel-Nr.
Cat. No.

Gesamtlänge
Total length

06-02-865

250 mm / 9³/₄"
45 x 35 mm

**COOLEY
modif.
STRUCK**

gerieft
serrated
cannelé
estriado
seghettato



1/3

06-02-866

250 mm / 9³/₄"
45 x 30 mm

**COOLEY
modif.
STRUCK**

gerieft
serrated
cannelé
estriado
seghettato



1/3



1/2



16 x 15 mm

ROSS

 Artikel-Nr.
 Cat. No.

02-70-970

 Gesamtlänge
 Total length

 255 mm / 10"
 Fig 1

 flexibler Schaft
 flexible shaft
 tige malléable
 vástago flexible
 asta flessibile

23 x 13 mm

ROSS

02-70-971

 255 mm / 10"
 Fig 2

 flexibler Schaft
 flexible shaft
 tige malléable
 vástago flexible
 asta flessibile

25 x 18 mm

ROSS

02-70-972

 255 mm / 10"
 Fig 3

 flexibler Schaft
 flexible shaft
 tige malléable
 vástago flexible
 asta flessibile

29 x 13 mm

ROSS

02-70-973

 255 mm / 10"
 Fig 4

 flexibler Schaft
 flexible shaft
 tige malléable
 vástago flexible
 asta flessibile

29 x 29 mm

ROSS

02-70-974

 255 mm / 10"
 Fig 5

 flexibler Schaft
 flexible shaft
 tige malléable
 vástago flexible
 asta flessibile





21 x 35 mm

ROSS

02-70-975

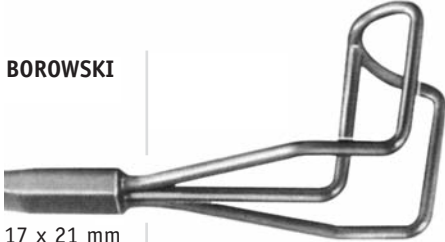
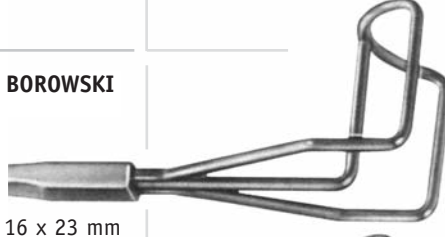
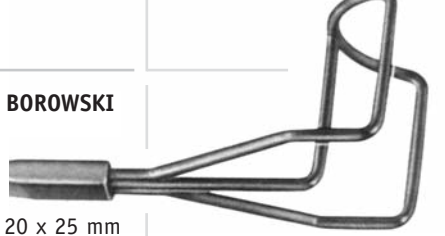
 255 mm / 10"
 Fig 6

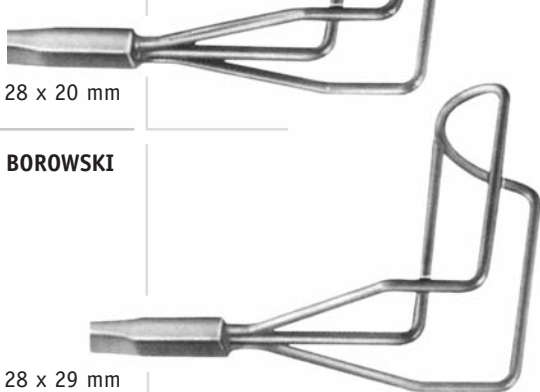
 flexibler Schaft
 flexible shaft
 tige malléable
 vástago flexible
 asta flessibile

Artikel-Nr. Cat. No.	Gesamtlänge Total length		
06-02-971	270 mm / 10 ³ / ₄ "	flexibler Schaft <i>flexible shaft</i> <i>tige malléable</i> <i>vástago flexible</i> <i>asta flessibile</i>	BOROWSKI  17 x 21 mm
06-02-972	270 mm / 10 ³ / ₄ "	flexibler Schaft <i>flexible shaft</i> <i>tige malléable</i> <i>vástago flexible</i> <i>asta flessibile</i>	BOROWSKI  16 x 23 mm
06-02-973	270 mm / 10 ³ / ₄ "	flexibler Schaft <i>flexible shaft</i> <i>tige malléable</i> <i>vástago flexible</i> <i>asta flessibile</i>	BOROWSKI  20 x 25 mm
06-02-974	270 mm / 10 ³ / ₄ "	flexibler Schaft <i>flexible shaft</i> <i>tige malléable</i> <i>vástago flexible</i> <i>asta flessibile</i>	BOROWSKI  24 x 27 mm
06-02-975	270 mm / 10 ³ / ₄ "	flexibler Schaft <i>flexible shaft</i> <i>tige malléable</i> <i>vástago flexible</i> <i>asta flessibile</i>	BOROWSKI  28 x 20 mm
06-02-976	270 mm / 10 ³ / ₄ "	flexibler Schaft <i>flexible shaft</i> <i>tige malléable</i> <i>vástago flexible</i> <i>asta flessibile</i>	BOROWSKI  28 x 29 mm





 Artikel-Nr.
 Cat. No.

 Gesamtlänge
 Total length

CRAWFORD

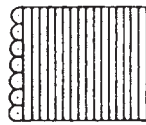
02-70-976

190 mm / 7¹/₂"

15 x 16 mm

CRAWFORD

02-70-977

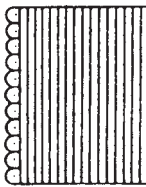
190 mm / 7¹/₂"

15 x 22 mm

Artikel-Nr.
Cat. No.

Gesamtlänge
Total length

06-52-670

160 mm / 6¹/₄"
ø 4 mm

KARP

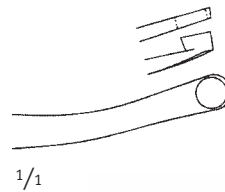

06-52-671

160 mm / 6¹/₄"
ø 5 mm

KARP

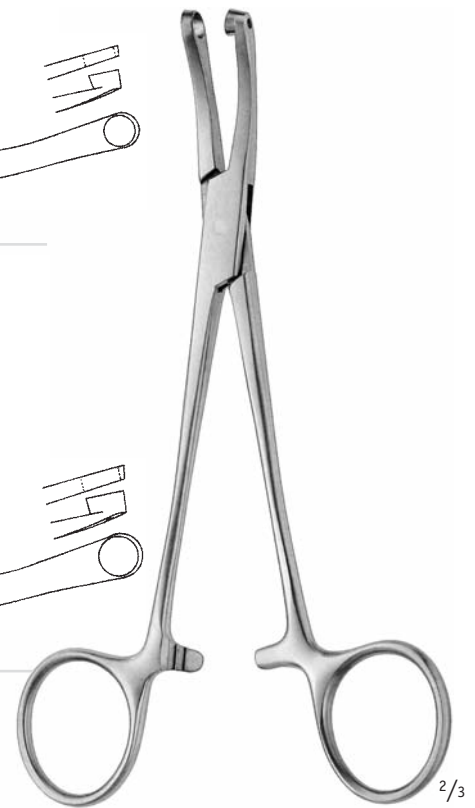
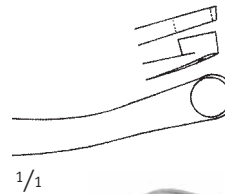



1/2

115 mm / 4 1/2"

 Artikel-Nr.
 Cat. No.

 Schaftlänge
 Length of shaft

BAILEY

115 mm / 4 1/2"

06-52-660

 gerade
 straight
 droite
 recto
 dritto

06-52-661

 25° nach unten
 25° downwards
 25° vers le bas
 25° hacia abajo
 25° in basso

06-52-662

 70° nach unten
 70° downwards
 70° vers le bas
 70° hacia abajo
 70° in basso

06-52-663

 90° nach rechts unten
 90° right downwards
 90° vers le droite bas
 90° hacia derecha abajo
 90° in destra basso



06-52-664

 45° nach links schneidend
 45° left side cutting
 45° coupante à gauche
 45° cortante hacia izquierda
 45° tagliente a sinistra

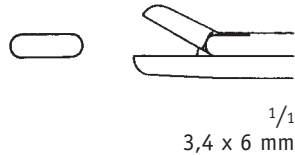
06-52-665

 45° nach rechts schneidend
 45° right side cutting
 45° coupante à droite
 45° cortante hacia derecha
 45° tagliente a destra

 1/1
 3,4 x 6 mm

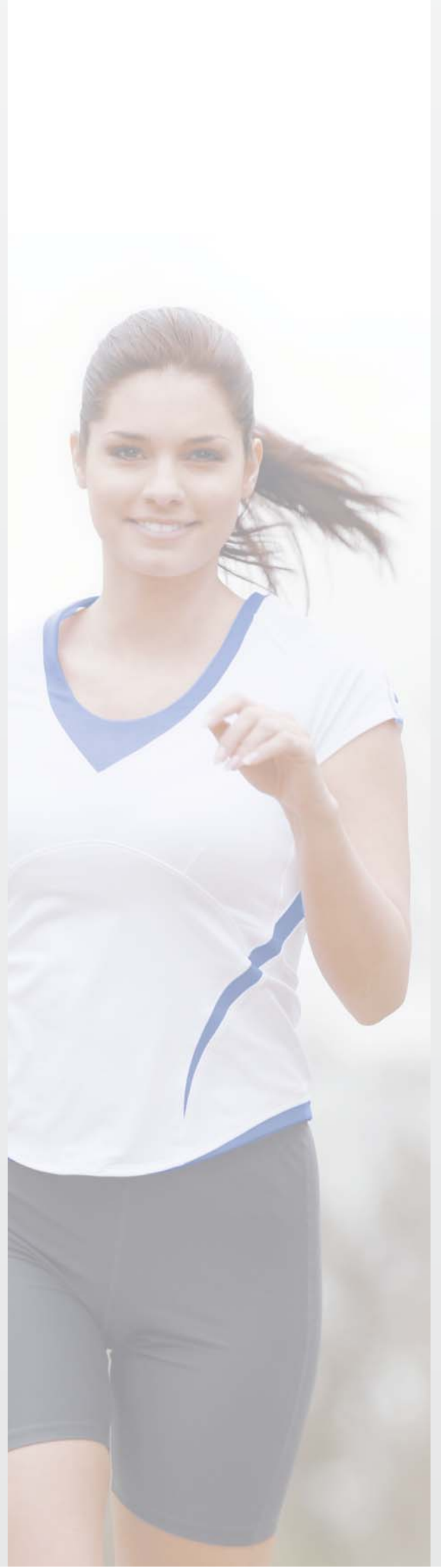

Artikel-Nr. Cat. No.	Artikel-Nr. Cat. No.	Artikel-Nr. Cat. No.	Schaftlänge Length of shaft		
06-06-799	06-56-769	06-56-760	130 mm / 5 ¹ / ₈ "	CUSHING	 1/1 2 x 10 mm
06-56-802	06-56-770	06-56-761	150 mm / 6"		
06-06-803	06-56-771	06-56-762	180 mm / 7"		
06-56-803	06-56-772	06-56-763	230 mm / 9"		
06-56-804	06-56-773	06-56-764	280 mm / 11"		
06-06-800	06-06-774	06-06-777	130 mm / 5 ¹ / ₈ "	LOVE-GRUENWALD	 1/1 3 x 10 mm
06-56-800	06-56-774	06-56-777	150 mm / 6"		
06-06-805	06-06-806	06-06-810	180 mm / 7"		
06-56-805	06-56-811	06-56-810	230 mm / 9"		
06-56-806	06-56-812	06-56-816	280 mm / 11"		
06-06-801	06-06-775	06-06-778	130 mm / 5 ¹ / ₈ "	SPURLING	 1/1 4 x 10 mm
06-56-801	06-56-775	06-56-807	150 mm / 6"		
06-06-807	06-06-814	06-06-811	180 mm / 7"		
06-56-808	06-56-814	06-56-817	230 mm / 9"		
06-56-809	06-56-815	06-56-818	280 mm / 11"		



Bulldogklemmen, Gefäßclips
Bulldog Clamps, Vessel Clips · Clamps Bulldog, Clips vasculaires
Clamps Bulldog, Clips vasculares · Pinze Bulldog, Clips vascolari

// 01

Atraumatische Gefäßklemmen
Atraumatic Vascular Clamps · Pincés vasculaires atraumatiques
Pinzas vasculares atraumáticas · Pinze vascolari atraumatiche

// 02

Atraumatische Pinzetten
Atraumatic Tissue Forceps · Pincés atraumatiques
Pinzas atraumáticas · Pinze atraumatiche

// 03

Rippensperrer
Rib Spreaders · Ecarteurs pour costaux
Separadores costales · Divaricatori costali

// 04

Atrium, Aorta-Instrumente
Atrium-, Aortic Instruments · Instruments pour l'oreillette et l'aorte
Instrumentos para el atrium y la aorta · Strumenti per atrio e aorta

// 05

Wundhaken, Wundspreizer
Retractors · Ecarteurs
Separadores · Divaricatori

// 06

Sonden, Dilatationsinstrumente
Probes, Instruments for dilatation · Sondes, Instruments pour la dilatation
Sondas, Instrumentos para la dilatación · Sonda, Strumenti a dilatazione

// 07

Mikro-Instrumente
Micro Instruments · Micro instruments
Instrumentos para microcirugía · strumenti per microchirurgia

// 08

Allgemeinchirurgische Instrumente
General surgery instruments · Instruments pour la chirurgie générale
Instrumentos para la cirugía general · Strumenti per chirurgia generale

// 09

Orthopädische Instrumente
Orthopaedic Instruments · Instruments pour l'orthopédie
Instrumentos para ortopedia · Strumenti per ortopedia

// 10







Artikel-Nr. Cat. No.	Länge Length
02-72-003	25 mm
I.M.A. Epikardialspreizer, spitz, mini I.M.A. Epicardial retractor, sharp, mini I.M.A. ecarteur épicaldial, pointu, mini I.M.A. Separador epicardiaco, agudo, mini I.M.A. Divaricatore epicardiaco, acuto, mini	

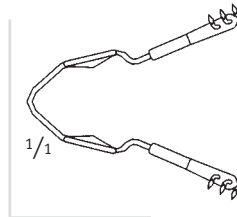

02-72-004	28 mm
I.M.A. Epikardialspreizer, spitz, klein I.M.A. Epicardial retractor, sharp, small I.M.A. ecarteur épicaldial, pointu, petit I.M.A. Separador epicardiaco, agudo, pequeño I.M.A. Divaricatore epicardiaco, acuto, piccolo	

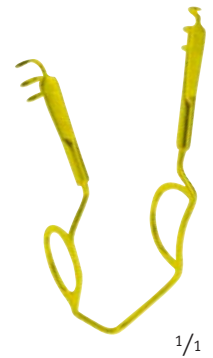
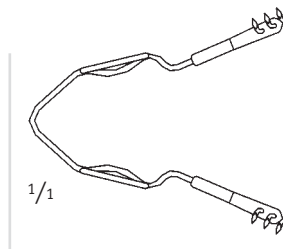

02-72-005	38 mm
I.M.A. Epikardialspreizer, spitz, mittel I.M.A. Epicardial retractor, sharp, medium I.M.A. ecarteur épicaldial, pointu, moyen I.M.A. Separador epicardiaco, agudo, mediano I.M.A. Divaricatore epicardiaco, acuto, medio	

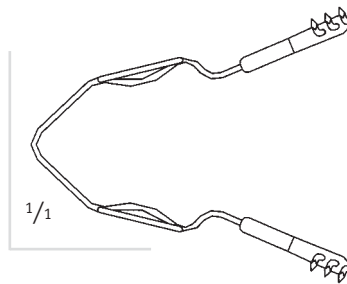

02-72-006	54 mm
I.M.A. Epikardialspreizer, spitz, groß I.M.A. Epicardial retractor, sharp, large I.M.A. ecarteur épicaldial, pointu, grand I.M.A. Separador epicardiaco, agudo, grande I.M.A. Divaricatore epicardiaco, acuto, grande	

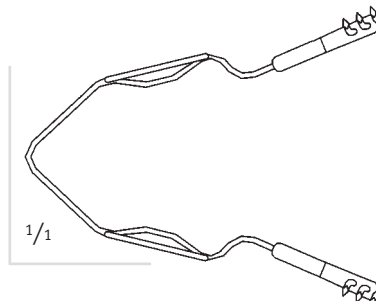

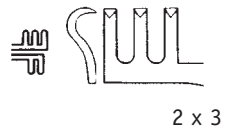

FINSEN

 Artikel-Nr.
 Cat. No.

02-22-001

 Gesamtlänge
 Total length

50 mm / 2"

 scharf
sharp · pointu · agudo · acuto

FINSEN

02-72-001

50 mm / 2"

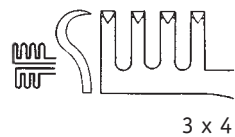
 stumpf
blunt · mousse · romo · smusso

FINSEN

02-22-002

70 mm / 2³/₄"
 scharf
sharp · pointu · agudo · acuto

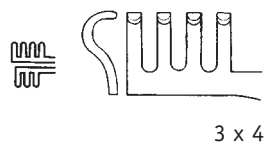

1/1





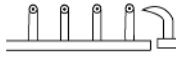

FINSEN

02-72-002

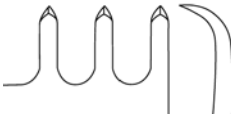
70 mm / 2³/₄"
 stumpf
blunt · mousse · romo · smusso

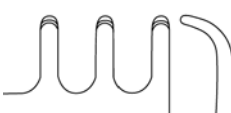
Artikel-Nr. Cat. No.	Gesamtlänge Total length			
02-22-010	70 mm / 2 ² / ₃ "	ALM		
02-72-010	100 mm / 4"			
scharf sharp · pointu · agudo · acuto			1/1	
02-72-011	70 mm / 2 ² / ₃ "	ALM		
02-22-011	100 mm / 4"			
stumpf blunt · mousse · romo · smusso			1/1	1/2

02-22-030	100 mm / 4"	JANSEN		
02-22-032	100 mm / 4"			
02-72-032	110 mm / 4 ³ / ₈ "	JANSEN		
scharf sharp · pointu · agudo · acuto			1/1	
stumpf blunt · mousse · romo · smusso			1/1	

02-22-028	95 mm / 3 ³ / ₄ "	ALLPORT		
scharf sharp · pointu · agudo · acuto				
				1/2

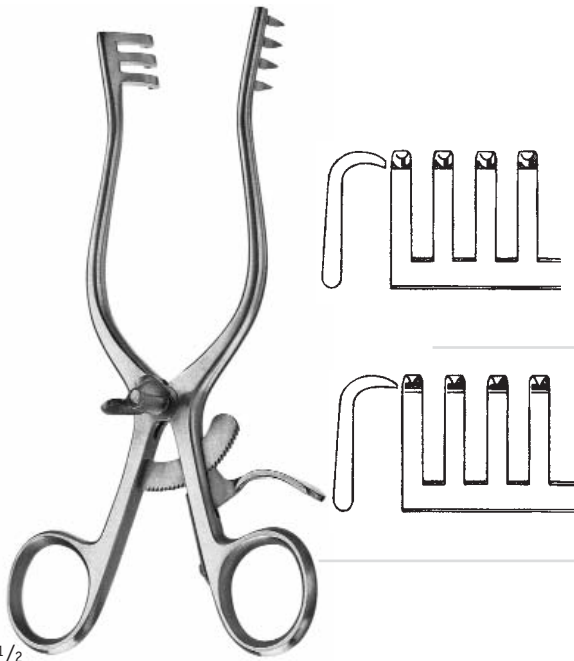

HENLEY

 Artikel-Nr.
 Cat. No.

02-72-100

 Gesamtlänge
 Total length

165 mm / 6 1/2"

stumpf, mit Mittelvalven 02-72-102 - 02-72-104
 blunt, with central blades 02-72-102 - 02-72-104
 mousse, avec lames centrales 02-72-102 - 02-72-104
 romo, con valvas centrales 02-72-102 - 02-72-104
 smusso, con lamierine centrali 02-72-102 - 02-72-104

HENLEY

02-72-101

165 mm / 6 1/2"

scharf, mit Mittelvalven 02-72-102 - 02-72-104
 sharp, with central blades 02-72-102 - 02-72-104
 pointu, avec lames centrales 02-72-102 - 02-72-104
 agudo, con valvas centrales 02-72-102 - 02-72-104
 acuto, con lamierine centrali 02-72-102 - 02-72-104

1/2

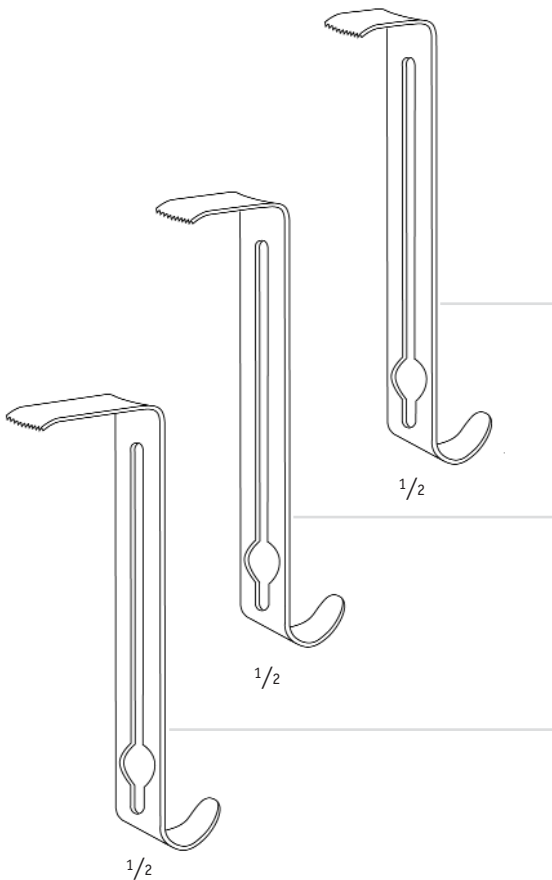

02-72-102

16 x 19 mm / 5/8" x 3/4"

Mittelvalven alleine
 central blade only · avec lames centrales
 con valvas centrales · con lamierine centrali

02-72-103

16 x 25 mm / 5/8" x 1"

Mittelvalven alleine
 central blade only · avec lames centrales
 con valvas centrales · con lamierine centrali

02-72-104

16 x 32 mm / 5/8" x 1 1/4"

Mittelvalven alleine
 central blade only · avec lames centrales
 con valvas centrales · con lamierine centrali

1/2

Artikel-Nr. Cat. No.	Gesamtlänge Total length
02-22-101	130 mm / 5 ¹ / ₈ "
	scharf sharp · pointu · agudo · acuto
02-22-072	165 mm / 6 ¹ / ₂ "
	scharf sharp · pointu · agudo · acuto
02-22-068	165 mm / 6 ¹ / ₂ "
	halbscharf semi-sharp · semi-pointu · semi-agudo · semi-acuto
02-22-104	130 mm / 5 ¹ / ₈ "
02-22-075	165 mm / 6 ¹ / ₂ "
	stumpf blunt · mousse · romo · smusso

WEITLANER

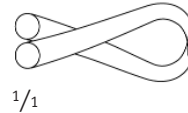

1/1

WEITLANER

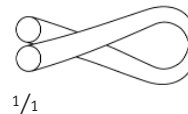

1/1



1/2

02-22-200	195 mm / 7 ³ / ₄ "
02-22-206	240 mm / 9 ¹ / ₂ "
02-22-208	255 mm / 10"
	scharf sharp · pointu · agudo · acuto
02-22-201	195 mm / 7 ³ / ₄ "
02-22-207	240 mm / 9 ¹ / ₂ "
02-22-209	255 mm / 10"
	stumpf blunt · mousse · romo · smusso

WEITLANER

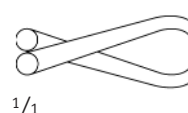

1/1

WEITLANER

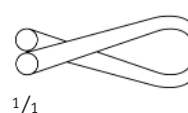

1/1



1/2



6

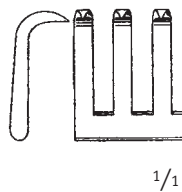

WEITLANER

 Artikel-Nr.
 Cat. No.

02-22-070

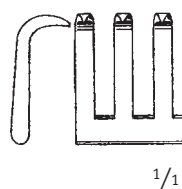
 Gesamtlänge
 Total length
115 mm / 4¹/₂"
 scharf
sharp · pointu · agudo · acuto

WEITLANER

02-22-066

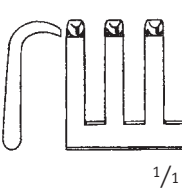
115 mm / 4¹/₂"
 halbscharf
semi-sharp · semi-pointu ·
semi-agudo · semi-acuto

WEITLANER

02-22-073

115 mm / 4¹/₂"
 stumpf
blunt · mousse · romo · smusso

1/2

1/1

1/1

1/1



6

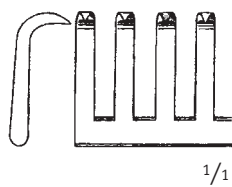

WEITLANER

02-22-071

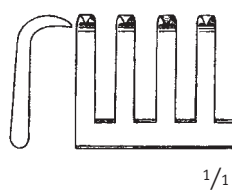
130 mm / 4¹/₄"
 scharf
sharp · pointu · agudo · acuto

WEITLANER

02-22-067

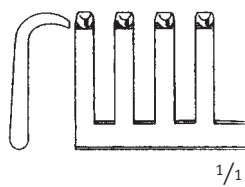
130 mm / 4¹/₄"
 halbscharf
semi-sharp · semi-pointu ·
semi-agudo · semi-acuto

WEITLANER

02-22-074











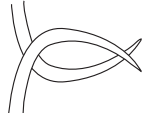

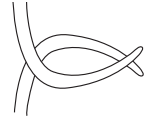
130 mm / 4¹/₄"
 stumpf
blunt · mousse · romo · smusso

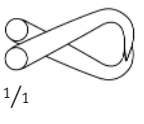
1/2

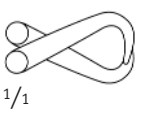
1/1

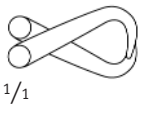
1/1

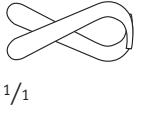
1/1

Artikel-Nr. Cat. No.	Gesamtlänge Total length			
02-22-083	145 mm / 5 ³ / ₄ "	CAIRNS		
02-72-083	160 mm / 6 ¹ / ₄ "			
	scharf sharp · pointu · agudo · acuto		1/1	
02-72-081	145 mm / 5 ³ / ₄ "	CAIRNS		
02-72-082	160 mm / 6 ¹ / ₄ "			
	stumpf blunt · mousse · romo · smusso		1/1	
02-72-088	140 mm / 5 ¹ / ₂ "	ADSON-BABY		
02-72-089	160 mm / 6 ¹ / ₄ "			
	scharf sharp · pointu · agudo · acuto		1/1	
02-22-085	140 mm / 5 ¹ / ₂ "	ADSON-BABY		
02-72-085	160 mm / 6 ¹ / ₄ "			
	halbscharf semi-sharp · semi-pointu · semi-agudo · semi-acuto		1/1	
02-72-086	140 mm / 5 ¹ / ₂ "	ADSON-BABY		
02-72-087	160 mm / 6 ¹ / ₄ "			
	stumpf blunt · mousse · romo · smusso		1/1	
02-22-092	140 mm / 5 ¹ / ₂ "	JEFFERSON		
	stumpf, gebogen blunt, curved · mousse, courbe · romo, curva · smusso, curva		1/1	





1/3

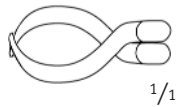

1/1

**BECKMANN-
ADSON**

 Artikel-Nr.
 Cat. No.

02-22-271

 Gesamtlänge
 Total length

310 mm / 12"

 halbscharf
 semi-sharp · semi-pointu ·
 semi-agudo · semi-acuto

1/1

**BECKMANN-
ADSON**

02-22-272

310 mm / 12"

 scharf
 sharp · pointu · agudo · acuto

1/3

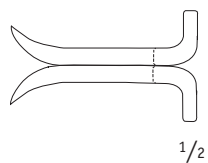

1/2

**BECKMANN-
EATON**

02-22-276

320 mm / 12³/₄"
 scharf
 sharp · pointu · agudo · acuto

Artikel-Nr. Cat. No.	Gesamtlänge Total length
02-72-210	220 mm / 8 ³ / ₄ "
scharf sharp · pointu · agudo · acuto	
02-72-211	220 mm / 8 ³ / ₄ "
stumpf blunt · mousse · romo · smusso	

MISKIMON

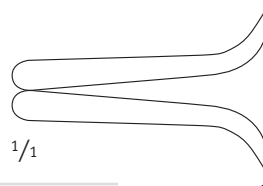

MISKIMON

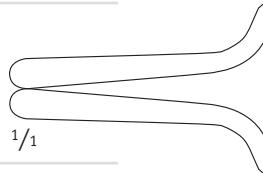

02-22-250	190 mm / 7 ¹ / ₄ "
scharf sharp · pointu · agudo · acuto	
02-72-249	190 mm / 7 ¹ / ₄ "
stumpf blunt · mousse · romo · smusso	

ANDERSON-ADSON

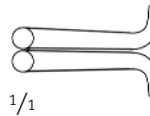

ANDERSON-ADSON

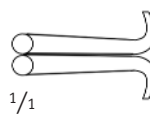

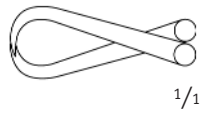

1/1

**WEITLANER-
BECKMANN**
 Artikel-Nr.
 Cat. No.

 Gesamtlänge
 Total length

02-72-220

140 mm / 5¹/₂"

02-72-221

170 mm / 6³/₄"

02-72-222

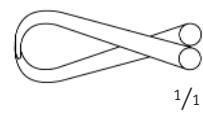
220 mm / 8³/₄"
 scharf
sharp · pointu · agudo · acuto

1/1

**WEITLANER-
BECKMANN**

02-72-223

140 mm / 5¹/₂"

02-72-224

170 mm / 6³/₄"

02-72-225

220 mm / 8³/₄"
 stumpf
blunt · mousse · romo · smusso

1/2

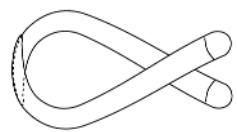

1/1

BECKMANN

02-72-226

310 mm / 12"

 scharf
sharp · pointu · agudo · acuto

1/3

Artikel-Nr. Cat. No.	Gesamtlänge Total length
02-72-257	130 mm / 5"
02-72-258	165 mm / 6 ¹ / ₂ "
02-72-260	200 mm / 8"
02-22-260	265 mm / 10 ¹ / ₂ "
scharf sharp · pointu · agudo · acuto	
02-72-259	130 mm / 5"
02-72-261	165 mm / 6 ¹ / ₂ "
02-72-262	200 mm / 8"
02-72-263	265 mm / 10 ¹ / ₂ "
stumpf blunt · mousse · romo · smusso	

CONE

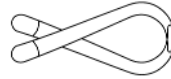

1/1

CONE

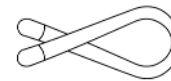

1/1

ADSON

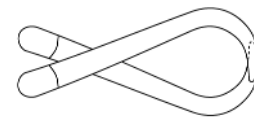

1/1



1/3

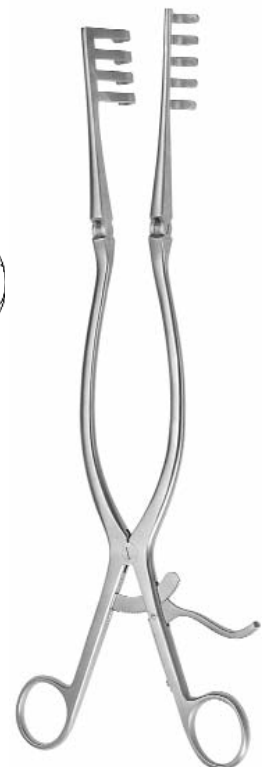

1/3





	Artikel-Nr. Cat. No.	Gesamtlänge Total length
DARLING	02-72-270	180 mm / 7"



DARLING	02-72-271	180 mm / 7"
----------------	------------------	-------------

Artikel-Nr.
 Cat. No.

Gesamtlänge
 Total length

02-22-608

250 mm / 10"

Bauchdeckenhalter, komplett
 Abdominal Retractor, complete
 Ecarteur abdominal, complet
 Separador abdominal, completo
 Divaricatori addominali, completo

BALFOUR

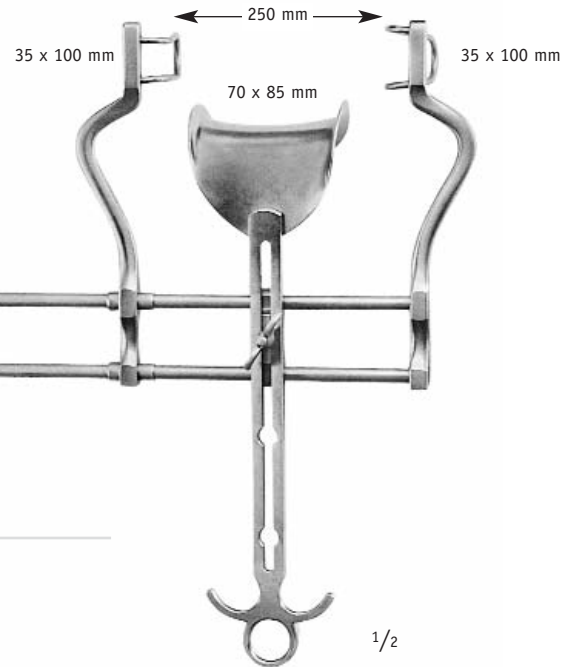

02-72-272

200 mm / 8"

Vaskular-Spreizer
 Vascular retractor
 Ecarteur vasculaire
 Separador vascular
 Divaricatori vascolari

OCHSNER

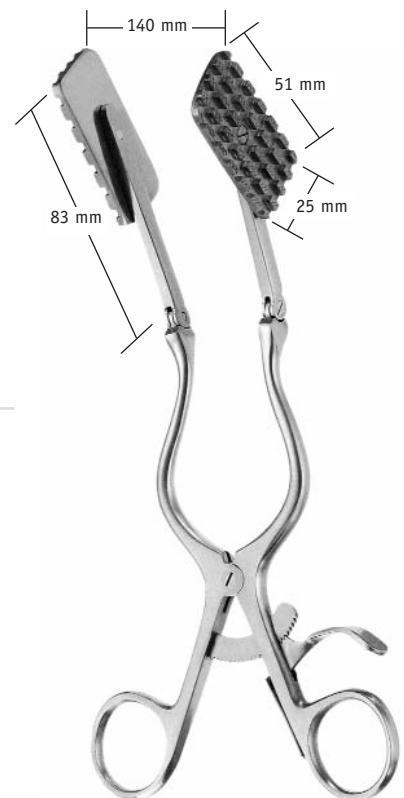

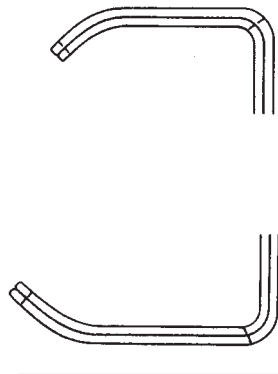
FARABEUF

 Artikel-Nr.
 Cat. No.

02-20-020

 Gesamtlänge
 Total length

 120 mm / 4³/₄"
 Fig. 1-2

 Fig 1: 26 x 10 mm / 30 x 13 mm
 Fig 2: 30 x 10 mm / 34 x 13 mm

FARABEUF
02-20-021

 150 mm / 6"
 Fig. 1-2

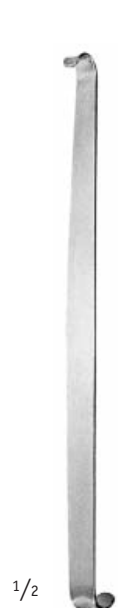
 Fig 1: 23 x 16 mm / 26 x 16 mm
 Fig 2: 27 x 16 mm / 30 x 16 mm

**ROUX
 mini**
02-70-022

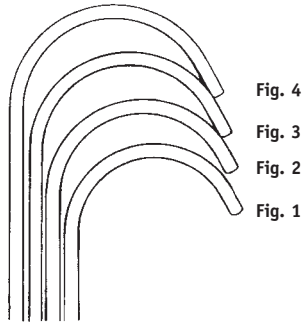
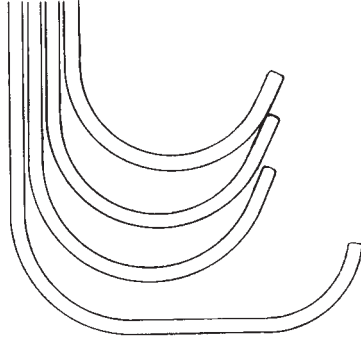
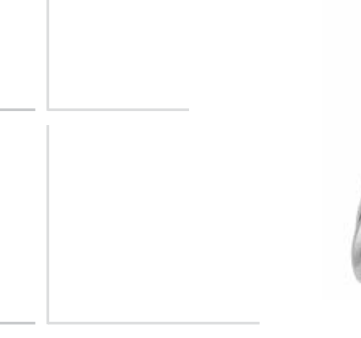
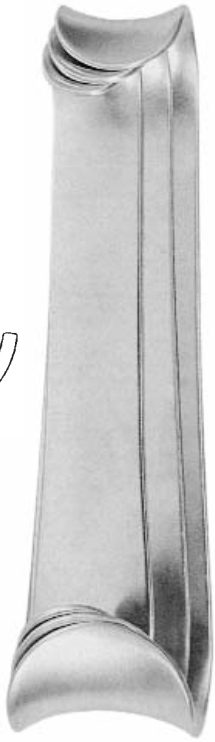
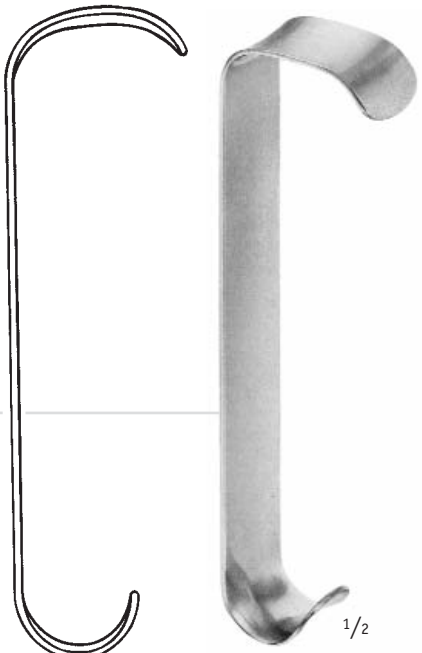
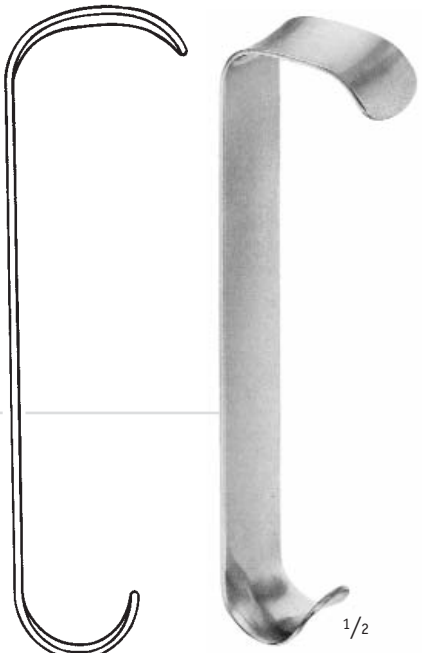
 150 mm / 6"
 8 x 6 mm

Artikel-Nr. Cat. No.	Gesamtlänge Total length	ROUX	
02-20-031	140 mm / 5 1/2" Fig. 1 24 x 20 mm / 30 x 28 mm	ROUX	 <p>Fig. 4 Fig. 3 Fig. 2 Fig. 1</p>
02-20-032	150 mm / 6" Fig. 2 29 x 26 mm / 36 x 36 mm	ROUX	 <p>Fig. 1</p>
02-20-033	170 mm / 6 3/4" Fig. 3 33 x 29 mm / 38 x 43 mm	ROUX	 <p>Fig. 4</p>
02-20-029	180 mm / 7" Fig. 4 29 x 24 mm / 45 x 28 mm	ROUX	 <p>1/2</p>
02-20-030	Satz, Fig. 1-3 Set, Fig. 1-3 Jeu, Fig. 1-3 Juego, Fig. 1-3 Serie, Fig. 1-3	ROUX	 <p>1/2</p>
02-20-028	170 mm / 6 3/4" 43 x 24 mm / 28 x 24 mm	ROUX	 <p>1/2</p>

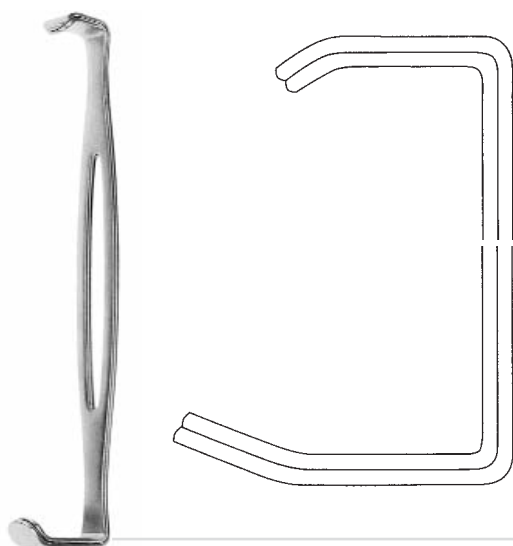



1/3

**US Army
(PARKER-
LANGEN-
BECK)**

 Artikel-Nr.
 Cat. No.

02-70-039

 Gesamtlänge
 Total length

 210 mm / 8¹/₄"
 Fig. 1

21 x 24 mm / 40 x 15 mm

**US Army
(PARKER-
LANGEN-
BECK)**

02-70-040

 210 mm / 8¹/₄"
 Fig. 2

25 x 24 mm / 45 x 15 mm

**US Army
(PARKER-
LANGEN-
BECK)**

02-20-041

 Satz, Fig. 1-2
 Set, Fig. 1-2
 Jeu, Fig. 1-2
 Juego, Fig. 1-2
 Serie, Fig. 1-2

1/3

RICHARDSON

02-20-471

 260 mm / 10¹/₄"
 Fig. 1

28 x 20 mm / 36 x 28 mm

RICHARDSON

02-20-472

 270 mm / 10³/₄"
 Fig. 2

49 x 38 mm / 63 x 49 mm

RICHARDSON

02-20-470

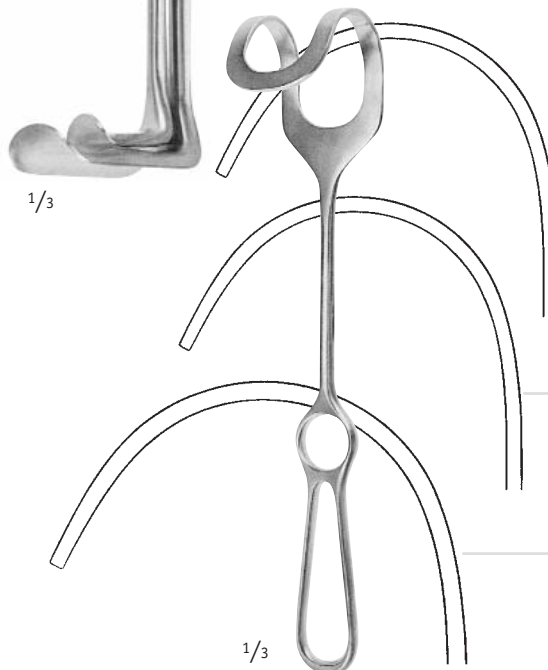
 Satz, Fig. 1-2
 Set, Fig. 1-2
 Jeu, Fig. 1-2
 Juego, Fig. 1-2
 Serie, Fig. 1-2

1/3

MIDDELDORPF

02-70-041

270 mm / 10³/₄"

48 x 45 mm

MIDDELDORPF

02-70-042

270 mm / 10³/₄"





52 x 50 mm

MIDDELDORPF

02-70-043

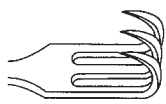
280 mm / 11"

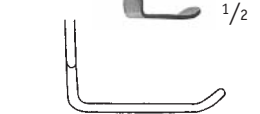
60 x 70 mm

Artikel-Nr. Cat. No.	Gesamtlänge Total length	SENN- MILLER		
02-20-008	170 mm / 6 ³ / ₄ " scharf <i>sharp · pointu · agudo · acuto</i>	SENN- MILLER	7 x 8,5 mm	
02-70-002	170 mm / 6 ³ / ₄ " stumpf <i>blunt · mousse · roma · smusso</i>	SENN- MILLER	7 x 8,5 mm	
02-20-004	150 mm / 6" 8 x 4 mm / 15 x 5,5 mm	RAGNELL		





28 x 20 mm

RICHARDSON

 Artikel-Nr.
 Cat. No.

02-20-475

 Gesamtlänge
 Total length

240 mm / 9½"



1/2



36 x 28 mm

RICHARDSON

02-20-476

240 mm / 9½"

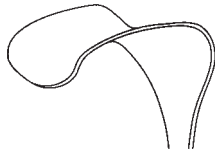

44 x 38 mm

RICHARDSON

02-20-477

240 mm / 9½"

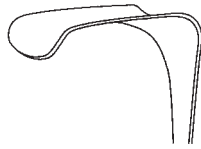

52 x 22 mm

RICHARDSON

02-20-478

240 mm / 9½"

Artikel-Nr. Cat. No.	Gesamtlänge Total length
02-20-481	260 mm / 10 ¹ / ₄ "

KELLY

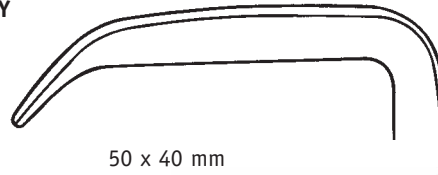

50 x 40 mm

02-20-482	260 mm / 10 ¹ / ₄ "
-----------	---

KELLY

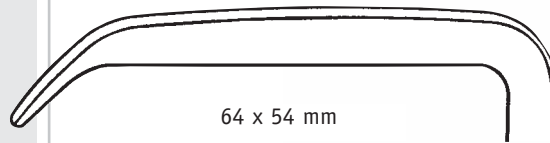

64 x 54 mm

02-20-483	260 mm / 10 ¹ / ₄ "
-----------	---

KELLY

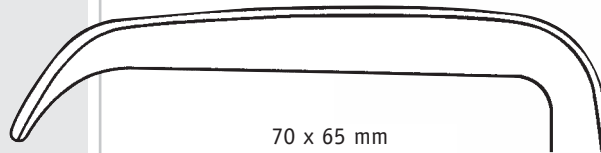

70 x 65 mm

02-20-484	260 mm / 10 ¹ / ₄ "
-----------	---

KELLY

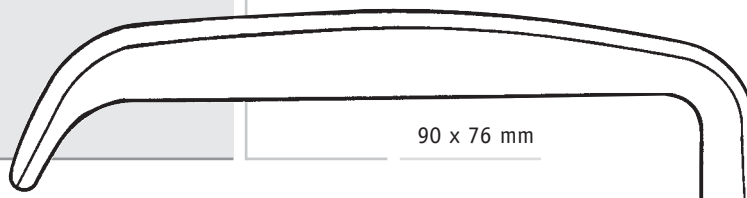

90 x 76 mm

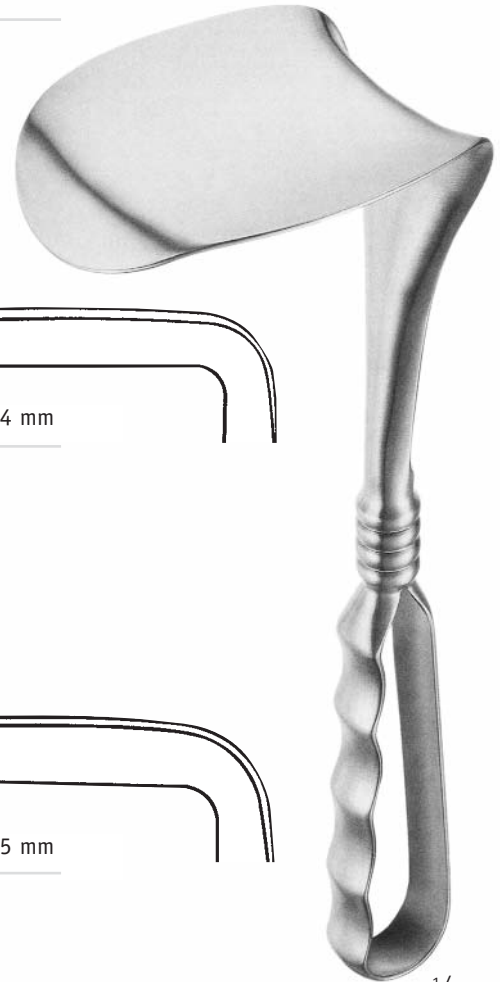

1/2



6

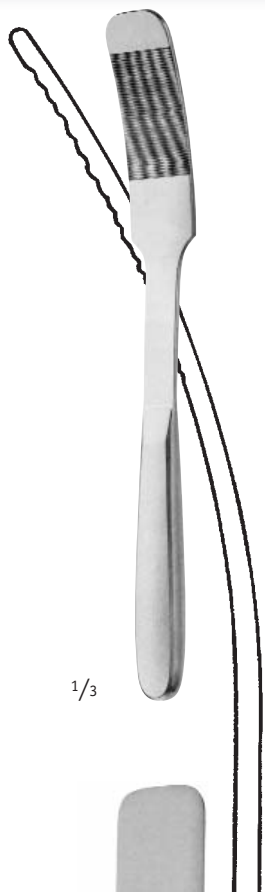

1/3

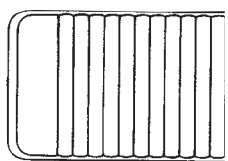

KADER

Artikel-Nr.
Cat. No.

02-70-745

Gesamtlänge
Total length

280 mm / 11"

20 mm

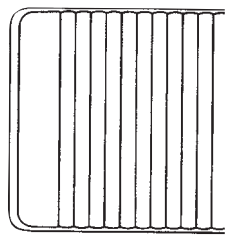

KADER

02-20-746

280 mm / 11"

30 mm

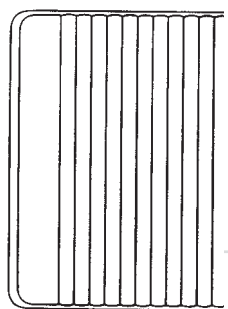

KADER

02-20-747

280 mm / 11"

40 mm



1/3

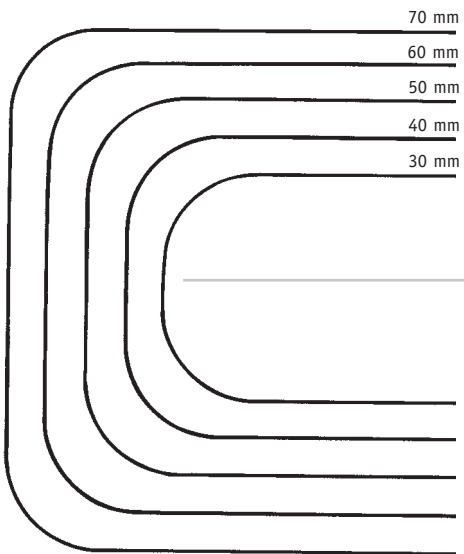

70 mm

60 mm

50 mm

40 mm

30 mm

02-20-773

02-20-774

02-20-775

02-20-776

02-20-777

410 mm / 16"

30 mm

40 mm

50 mm

60 mm

70 mm

biegsam





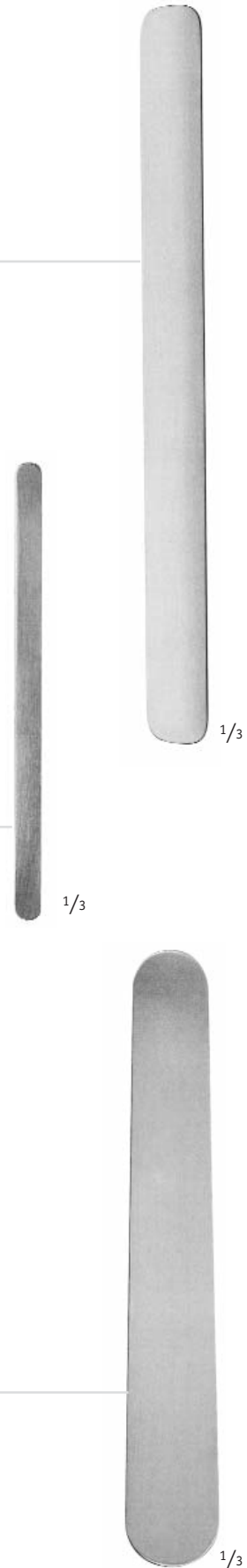



malleable · malléable · maleable · malleabile

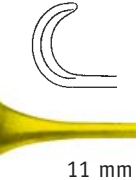

Artikel-Nr. Cat. No.	Gesamtlänge Total length		
02-70-760	330 mm / 13 ¹ / ₈ " 25 mm biegsam · malleable · malléable · maleable · malleabile		
02-20-761	330 mm / 13 ¹ / ₈ " 32 mm biegsam · malleable · malléable · maleable · malleabile		
02-20-762	330 mm / 13 ¹ / ₈ " 40 mm biegsam · malleable · malléable · maleable · malleabile		
02-20-763	330 mm / 13 ¹ / ₈ " 50 mm biegsam · malleable · malléable · maleable · malleabile		
02-70-764	200 mm / 8" 6,5 mm biegsam · malleable · malléable · maleable · malleabile	MARTIN	
02-70-765	200 mm / 8" 9,5 mm biegsam · malleable · malléable · maleable · malleabile	MARTIN	
02-70-766	200 mm / 8" 13 mm biegsam · malleable · malléable · maleable · malleabile	MARTIN	
02-70-767	200 mm / 8" 16 mm biegsam · malleable · malléable · maleable · malleabile	MARTIN	
02-70-768	200 mm / 8" 19 mm biegsam · malleable · malléable · maleable · malleabile	MARTIN	
02-70-769	200 mm / 8" 25 mm biegsam · malleable · malléable · maleable · malleabile	MARTIN	
02-20-750	200 mm / 8" 17 mm / 25 mm biegsam · malleable · malléable · maleable · malleabile	HABERER	
02-70-751	280 mm / 11" 25 mm / 30 mm biegsam · malleable · malléable · maleable · malleabile	HABERER	
02-20-758	300 mm / 12" 37 mm / 45 mm biegsam · malleable · malléable · maleable · malleabile	HABERER	



1/2

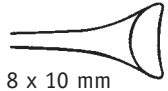

		Artikel-Nr. Cat. No.	Gesamtlänge Total length
 4 mm	GIL VERNET	02-70-770	240 mm / 9 ¹ / ₂ " Sattelhäkchen, biegsamer Schaft Saddle hook, malleable shaft Ecarteur sous forme de selle, tige malléable Gancho en forma de silla, vástago maleable Divaricatori a forma di sella, asta malleabile
 8 mm	GIL VERNET	02-70-771	240 mm / 9 ¹ / ₂ " Sattelhäkchen, biegsamer Schaft Saddle hook, malleable shaft Ecarteur sous forme de selle, tige malléable Gancho en forma de silla, vástago maleable Divaricatori a forma di sella, asta malleabile
 11 mm	GIL VERNET	02-70-772	240 mm / 9 ¹ / ₂ " Sattelhäkchen, biegsamer Schaft Saddle hook, malleable shaft Ecarteur sous forme de selle, tige malléable Gancho en forma de silla, vástago maleable Divaricatori a forma di sella, asta malleabile
 13 mm	GIL VERNET	02-70-773	240 mm / 9 ¹ / ₂ " Sattelhäkchen, biegsamer Schaft Saddle hook, malleable shaft Ecarteur sous forme de selle, tige malléable Gancho en forma de silla, vástago maleable Divaricatori a forma di sella, asta malleabile
 15 mm	GIL VERNET	02-70-774	240 mm / 9 ¹ / ₂ " Sattelhäkchen, biegsamer Schaft Saddle hook, malleable shaft Ecarteur sous forme de selle, tige malléable Gancho en forma de silla, vástago maleable Divaricatori a forma di sella, asta malleabile
 17 mm	GIL VERNET	02-70-775	240 mm / 9 ¹ / ₂ " Sattelhäkchen, biegsamer Schaft Saddle hook, malleable shaft Ecarteur sous forme de selle, tige malléable Gancho en forma de silla, vástago maleable Divaricatori a forma di sella, asta malleabile
 20 mm	GIL VERNET	02-70-776	240 mm / 9 ¹ / ₂ " Sattelhäkchen, biegsamer Schaft Saddle hook, malleable shaft Ecarteur sous forme de selle, tige malléable Gancho en forma de silla, vástago maleable Divaricatori a forma di sella, asta malleabile
 23 mm	GIL VERNET	02-70-777	240 mm / 9 ¹ / ₂ " Sattelhäkchen, biegsamer Schaft Saddle hook, malleable shaft Ecarteur sous forme de selle, tige malléable Gancho en forma de silla, vástago maleable Divaricatori a forma di sella, asta malleabile

Artikel-Nr. Cat. No.	Gesamtlänge Total length			
02-20-200	250 mm / 10"	CUSHING		11 x 14 mm
02-20-201	250 mm / 10"	CUSHING		13 x 18 mm
02-20-202	250 mm / 10"	CUSHING		15 x 22 mm
02-20-192	210 mm / 8 ¹ / ₄ " 6 x 13 mm	SCHOEN- BORN		
02-70-190	215 mm / 8 ¹ / ₂ " Venenhaken Vein Retractor Ecarteur à veines Gancho para venas Divaricatore per vene	CUSHING	 	8 x 10 mm
				







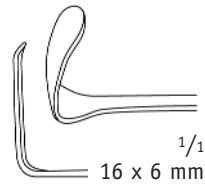
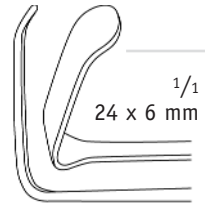
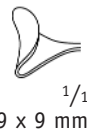
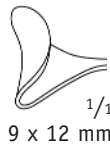
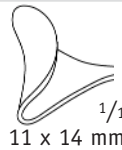
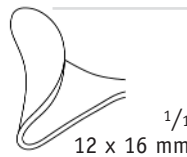
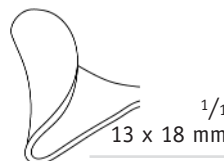



2/3

**LANGENBECK-GREEN**Artikel-Nr.
Cat. No.**02-20-177**Gesamtlänge
Total length160 mm / 6¹/₄"**LANGENBECK-GREEN****02-20-178**160 mm / 6¹/₄"**DESMARRES****15-01-310**140 mm / 5¹/₂"**DESMARRES****15-01-311**140 mm / 5¹/₂"**DESMARRES****15-01-312**140 mm / 5¹/₂"**DESMARRES****15-01-313**140 mm / 5¹/₂"**DESMARRES****15-01-314**140 mm / 5¹/₂"

2/3

Artikel-Nr. Cat. No.	Gesamtlänge Total length		
02-70-180	205 mm / 8"	CUSHING	 1/1 8 mm
02-70-181	240 mm / 9 1/2"		
02-20-184	205 mm / 8"	CUSHING	 1/1 10 mm
02-70-182	240 mm / 9 1/2"		
02-70-184	205 mm / 8"	CUSHING	 1/1 12 mm
02-70-183	240 mm / 9 1/2"		
02-20-185	205 mm / 8"	CUSHING	 1/1 14 mm
02-70-187	240 mm / 9 1/2"		
02-70-185	205 mm / 8"	CUSHING	 1/1 16 mm
02-70-188	240 mm / 9 1/2"		
02-70-186	205 mm / 8"	CUSHING	 1/1 18 mm
02-70-189	240 mm / 9 1/2"		



2/3





1/2



13 x 13 mm

KOENIG
 Artikel-Nr.
 Cat. No.
02-20-182
 Gesamtlänge
 Total length

180 mm / 7"



13 x 16 mm

KOENIG**02-20-183**

180 mm / 7"



1/2



19 x 12 mm

KOCHER**02-20-457**

190 mm / 7 1/2"



21 x 14 mm

KOCHER**02-20-458**

190 mm / 7 1/2"



1/2









10 x 10 mm

**CUSHING-
KOCHER****02-20-190**

175 mm / 7"

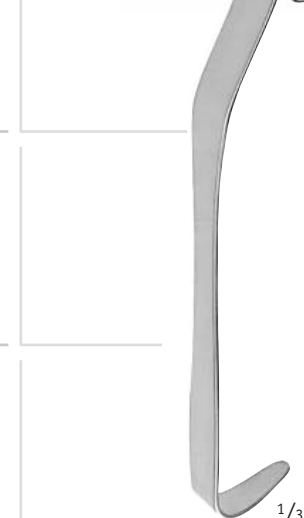

6

Artikel-Nr. Cat. No.	Gesamtlänge Total length		
02-20-600	180 mm / 7" 19 mm	DEAVER	
02-20-601	215 mm / 8½" 22 mm	DEAVER	
02-20-606	230 mm / 9" 25 mm	DEAVER	
02-20-602	300 mm / 12" 25 mm	DEAVER	
02-20-603	330 mm / 13" 25 mm	DEAVER	
02-20-607	360 mm / 14" 25 mm	DEAVER	





	Artikel-Nr. Cat. No.	Gesamtlänge Total length
DEAVER	02-20-604	300 mm / 12" 38 mm
DEAVER	02-20-605	300 mm / 12" 50 mm
DEAVER	02-20-608	300 mm / 12" 75 mm
DEAVER	02-20-611	310 mm / 12 ¹ / ₄ " 25 mm
DEAVER	02-20-613	310 mm / 12 ¹ / ₄ " 38 mm
DEAVER	02-20-614	310 mm / 12 ¹ / ₄ " 50 mm
DEAVER	02-20-615	310 mm / 12 ¹ / ₄ " 75 mm
DEAVER	02-70-616	310 mm / 12 ¹ / ₄ " 100 mm

1/3

1/3

1/3



Artikel-Nr. Cat. No.	Gesamtlänge Total length
02-20-730	255 mm / 10"
02-20-732	275 mm / 10 ³ / ₄ "

LERICHE
45 mm

LERICHE
60 mm

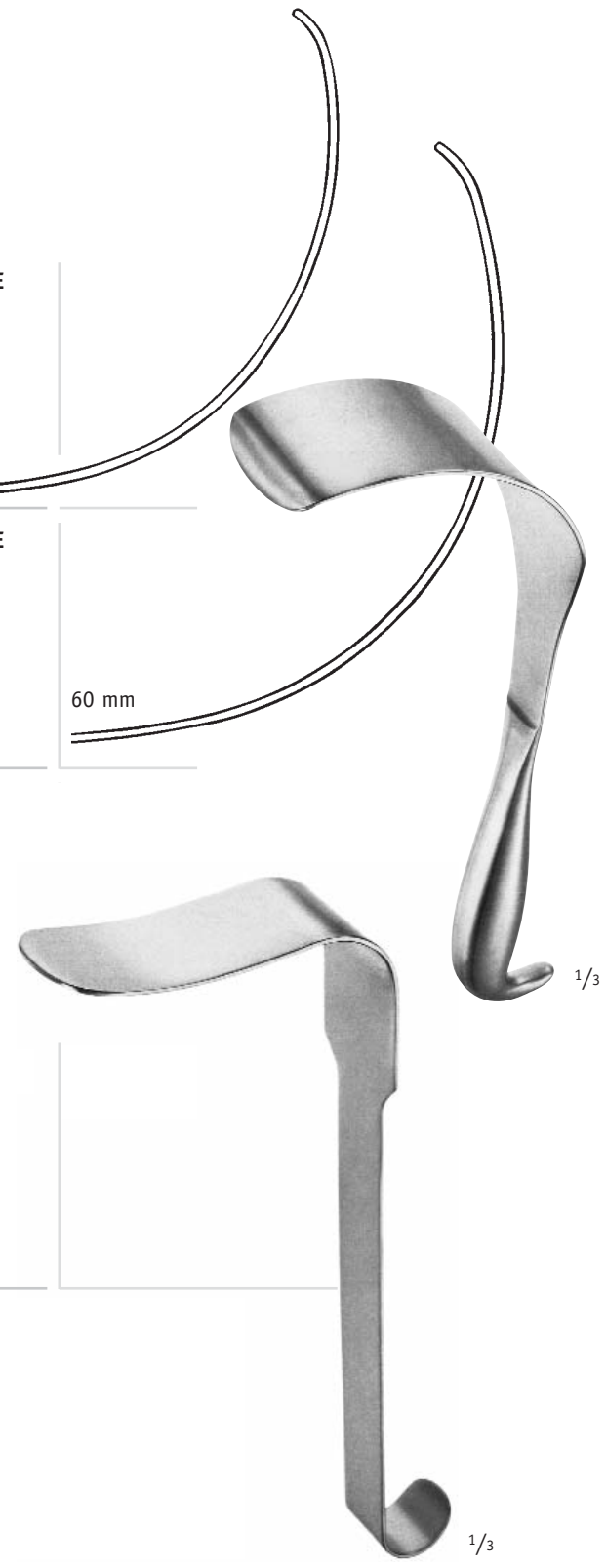





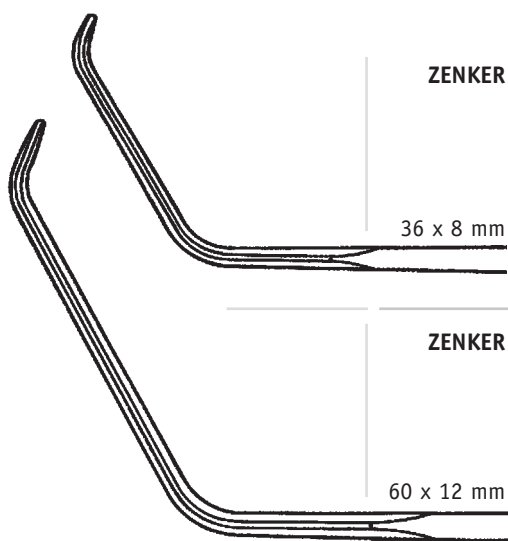
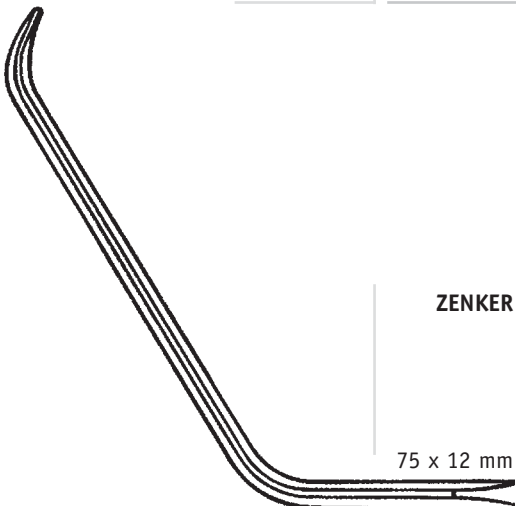
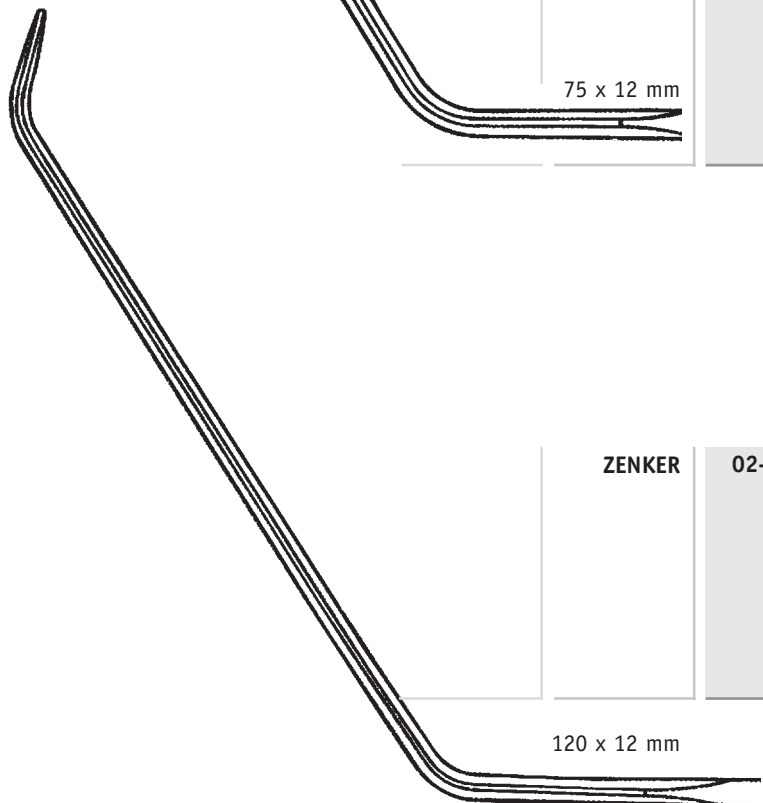

02-20-742	280 mm / 11" 120 x 47 mm starr <i>rigid · rigide · rígido · rigido</i>
-----------	---

KOERTE

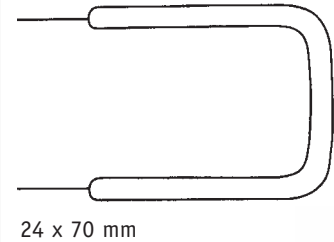

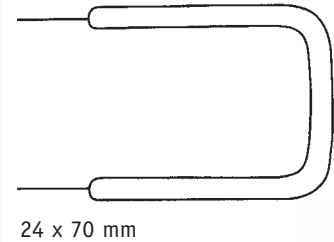
	ZENKER 36 x 8 mm	Artikel-Nr. <i>Cat. No.</i> 02-20-594	Gesamtlänge <i>Total length</i> 240 mm / 9 ¹ / ₂ "
	ZENKER 60 x 12 mm	02-20-595	255 mm / 10 ¹ / ₂ "
	ZENKER 75 x 12 mm	02-20-596	270 mm / 10 ³ / ₄ "
	ZENKER 120 x 12 mm	02-20-597	290 mm / 11 ¹ / ₂ "

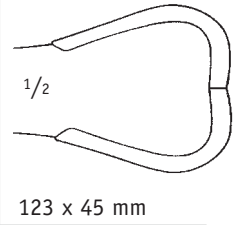

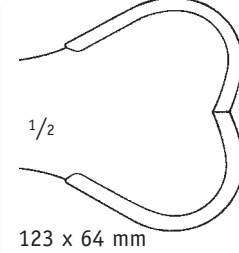
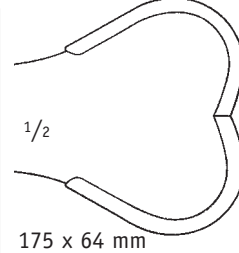



1/2

Artikel-Nr. Cat. No.	Gesamtlänge Total length	HARRINGTON- BABY	 24 x 70 mm	 1/3
02-70-550	250 mm / 10"	HARRINGTON- BABY	 24 x 70 mm	 1/3
02-20-551	295 mm / 11½"	HARRINGTON	 1/2 123 x 45 mm	 1/3
02-20-552	295 mm / 11½"	HARRINGTON	 1/2 123 x 64 mm	
02-20-553	295 mm / 11½"	HARRINGTON	 1/2 175 x 64 mm	



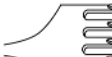

		Artikel-Nr. Cat. No.	Gesamtlänge Total length
	VOLKMANN	02-70-241	220 mm / 8 ³ / ₄ " scharf sharp · pointu · agudo · acuto
	VOLKMANN	02-20-242	220 mm / 8 ³ / ₄ " scharf sharp · pointu · agudo · acuto
	VOLKMANN	02-20-243	220 mm / 8 ³ / ₄ " scharf sharp · pointu · agudo · acuto
	VOLKMANN	02-20-244	220 mm / 8 ³ / ₄ " scharf sharp · pointu · agudo · acuto
	VOLKMANN	02-20-246	220 mm / 8 ³ / ₄ " scharf sharp · pointu · agudo · acuto
	VOLKMANN	02-20-248	220 mm / 8 ³ / ₄ " scharf sharp · pointu · agudo · acuto

Artikel-Nr. Cat. No.	Gesamtlänge Total length		
02-70-255	220 mm / 8 ³ / ₄ "	VOLKMANN	 1/2
02-20-257	220 mm / 8 ³ / ₄ "	VOLKMANN	 1/2 9 x 8 mm
02-20-259	220 mm / 8 ³ / ₄ "	VOLKMANN	 1/2 9 x 13 mm
02-20-260	220 mm / 8 ³ / ₄ "	VOLKMANN	 1/2 9 x 19 mm
02-20-261	220 mm / 8 ³ / ₄ "	VOLKMANN	 1/2 9 x 29 mm
02-20-265	220 mm / 8 ³ / ₄ "	VOLKMANN	 1/2 9 x 40 mm

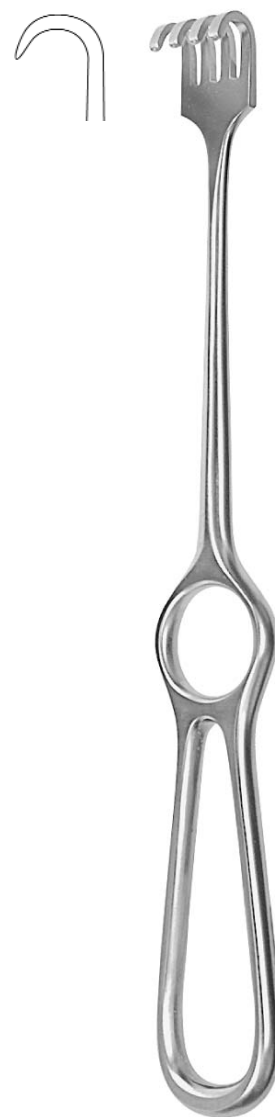

2/3



6

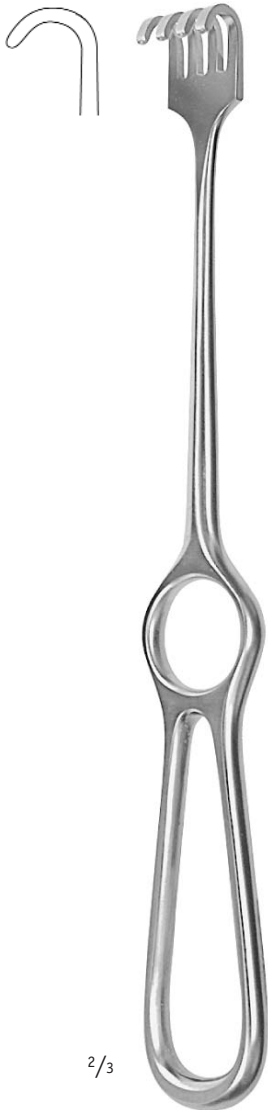

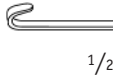
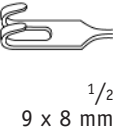
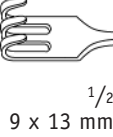
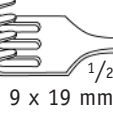
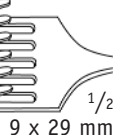
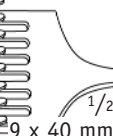
		Artikel-Nr. Cat. No.	Gesamtlänge Total length
	VOLKMANN	02-70-250	220 mm / 8 ³ / ₄ " stumpf blunt · mousse · romo · smusso
	VOLKMANN	02-20-252	220 mm / 8 ³ / ₄ " stumpf blunt · mousse · romo · smusso
	VOLKMANN	02-20-253	220 mm / 8 ³ / ₄ " stumpf blunt · mousse · romo · smusso
	VOLKMANN	02-20-254	220 mm / 8 ³ / ₄ " stumpf blunt · mousse · romo · smusso
	VOLKMANN	02-20-256	220 mm / 8 ³ / ₄ " stumpf blunt · mousse · romo · smusso
	VOLKMANN	02-20-258	220 mm / 8 ³ / ₄ " stumpf blunt · mousse · romo · smusso

2/3

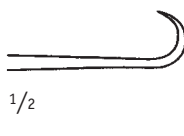
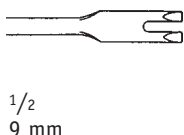
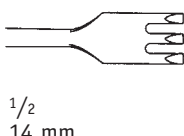
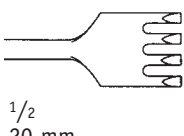
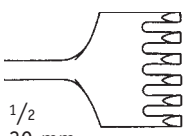
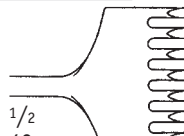
Artikel-Nr. Cat. No.	Gesamtlänge Total length		
02-20-238	220 mm / 8 ³ / ₄ "	KOCHER	 1/2
02-20-262	220 mm / 8 ³ / ₄ "	KOCHER	 1/2 9 mm
02-20-263	220 mm / 8 ³ / ₄ "	KOCHER	 1/2 14 mm
02-20-264	220 mm / 8 ³ / ₄ "	KOCHER	 1/2 20 mm
02-20-266	220 mm / 8 ³ / ₄ "	KOCHER	 1/2 30 mm
02-70-267	220 mm / 8 ³ / ₄ "	KOCHER	 1/2 40 mm









2/3



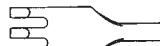





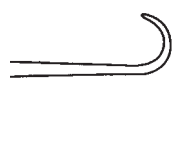
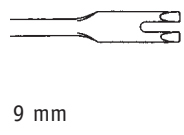
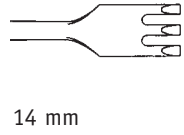
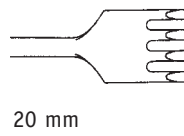
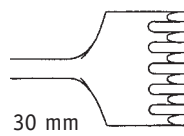
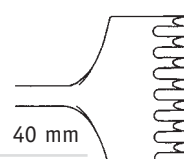

2/3

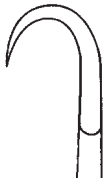
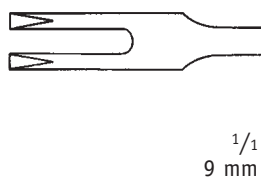
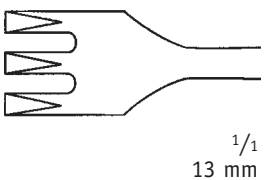
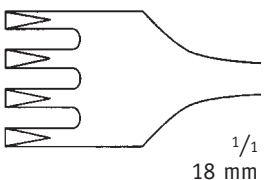
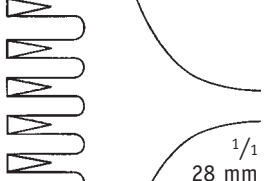
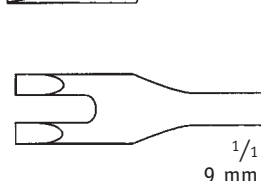
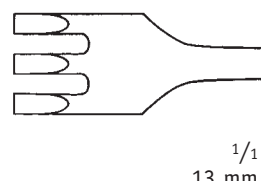
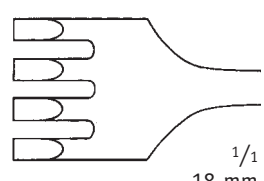
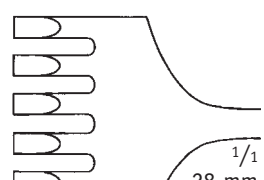
		Artikel-Nr. Cat. No.	Gesamtlänge Total length
	KOCHER	02-20-239	220 mm / 8 ³ / ₄ " stumpf <i>blunt · mousse · romo · smusso</i>
 9 mm	KOCHER	02-20-272	220 mm / 8 ³ / ₄ " stumpf <i>blunt · mousse · romo · smusso</i>
 14 mm	KOCHER	02-20-273	220 mm / 8 ³ / ₄ " stumpf <i>blunt · mousse · romo · smusso</i>
 20 mm	KOCHER	02-20-274	220 mm / 8 ³ / ₄ " stumpf <i>blunt · mousse · romo · smusso</i>
 30 mm	KOCHER	02-20-276	220 mm / 8 ³ / ₄ " stumpf <i>blunt · mousse · romo · smusso</i>
 40 mm	KOCHER	02-70-277	220 mm / 8 ³ / ₄ " stumpf <i>blunt · mousse · romo · smusso</i>

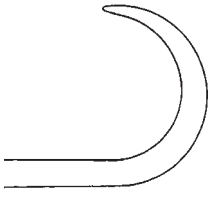
Artikel-Nr. Cat. No.	Gesamtlänge Total length		
02-70-280	220 mm / 8 ³ / ₄ "	halbscharf semi-sharp · semi-pointu · semi-agudo · semi-acuto	
02-70-281	220 mm / 8 ³ / ₄ "	halbscharf semi-sharp · semi-pointu · semi-agudo · semi-acuto	 <p>9 mm</p>
02-70-282	220 mm / 8 ³ / ₄ "	halbscharf semi-sharp · semi-pointu · semi-agudo · semi-acuto	 <p>14 mm</p>
02-70-283	220 mm / 8 ³ / ₄ "	halbscharf semi-sharp · semi-pointu · semi-agudo · semi-acuto	 <p>20 mm</p>
02-70-284	220 mm / 8 ³ / ₄ "	halbscharf semi-sharp · semi-pointu · semi-agudo · semi-acuto	 <p>30 mm</p>
02-70-285	220 mm / 8 ³ / ₄ "	halbscharf semi-sharp · semi-pointu · semi-agudo · semi-acuto	 <p>40 mm</p>

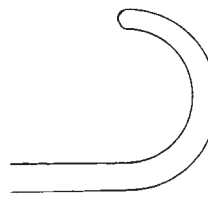

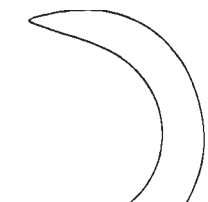
			Artikel-Nr. Cat. No.	Gesamtlänge Total length
 1/2		 $\frac{1}{1}$ 9 mm	MURPHY 02-70-290	195 mm / 7 ³ / ₄ " scharf <i>sharp · pointu · agudo · acuto</i>
		 $\frac{1}{1}$ 13 mm	MURPHY 02-70-291	195 mm / 7 ³ / ₄ " scharf <i>sharp · pointu · agudo · acuto</i>
		 $\frac{1}{1}$ 18 mm	MURPHY 02-70-292	195 mm / 7 ³ / ₄ " scharf <i>sharp · pointu · agudo · acuto</i>
		 $\frac{1}{1}$ 28 mm	MURPHY 02-70-293	195 mm / 7 ³ / ₄ " scharf <i>sharp · pointu · agudo · acuto</i>
		 $\frac{1}{1}$ 9 mm	MURPHY 02-70-294	195 mm / 7 ³ / ₄ " stumpf <i>blunt · mousse · romo · smusso</i>
		 $\frac{1}{1}$ 13 mm	MURPHY 02-70-295	195 mm / 7 ³ / ₄ " stumpf <i>blunt · mousse · romo · smusso</i>
		 $\frac{1}{1}$ 18 mm	MURPHY 02-70-296	195 mm / 7 ³ / ₄ " stumpf <i>blunt · mousse · romo · smusso</i>
		 $\frac{1}{1}$ 28 mm	MURPHY 02-70-297	195 mm / 7 ³ / ₄ " stumpf <i>blunt · mousse · romo · smusso</i>

Artikel-Nr. Cat. No.	Gesamtlänge Total length			
02-20-240	215 mm / 8 ¹ / ₂ " scharf sharp · pointu · agudo · acuto	VOLKMANN		
02-20-241	215 mm / 8 ¹ / ₂ " stumpf blunt · mousse · romo · smusso	VOLKMANN		
02-20-232	215 mm / 8 ¹ / ₂ " scharf sharp · pointu · agudo · acuto	VOLKMANN		





2/3

ISRAEL

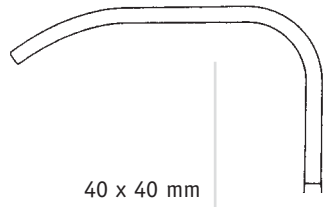

40 x 40 mm

 Artikel-Nr.
 Cat. No.

02-20-284

 Gesamtlänge
 Total length

250 mm / 10"

 stumpf
 blunt · mousse · romo · smusso

ISRAEL

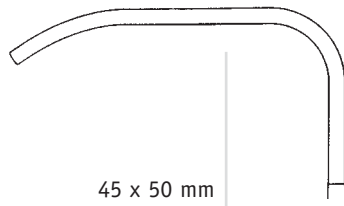

45 x 50 mm

02-20-285

250 mm / 10"

 stumpf
 blunt · mousse · romo · smusso

ISRAEL

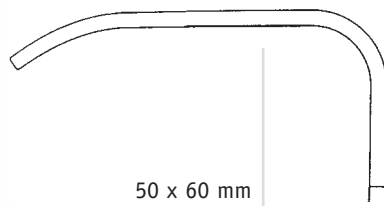

50 x 60 mm

02-20-286

250 mm / 10"

 stumpf
 blunt · mousse · romo · smusso

ISRAEL

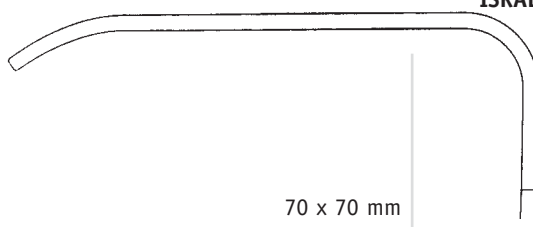



70 x 70 mm

02-20-287

250 mm / 10"

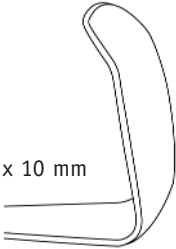
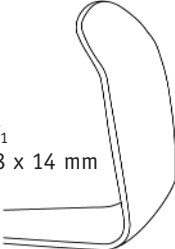
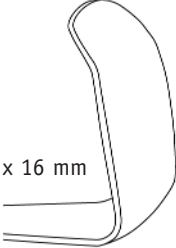
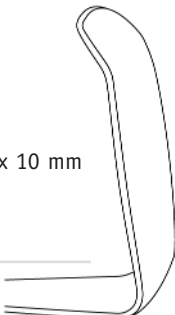
 stumpf
 blunt · mousse · romo · smusso

Artikel-Nr. Cat. No.	Gesamtlänge Total length			
02-20-320	210 mm / 8 ¹ / ₄ "	LANGEN-BECK	¹ / ₁ 28 x 10 mm	
02-20-321	210 mm / 8 ¹ / ₄ "	LANGEN-BECK	¹ / ₁ 28 x 14 mm	
02-20-323	210 mm / 8 ¹ / ₄ "	LANGEN-BECK	¹ / ₁ 28 x 16 mm	
02-20-325	210 mm / 8 ¹ / ₄ "	LANGEN-BECK	¹ / ₁ 40 x 10 mm	
02-20-326	210 mm / 8 ¹ / ₄ "	LANGEN-BECK	¹ / ₁ 40 x 13 mm	



2/3





1/2

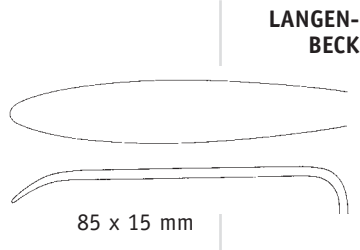

 Artikel-Nr.
 Cat. No.

 Gesamtlänge
 Total length

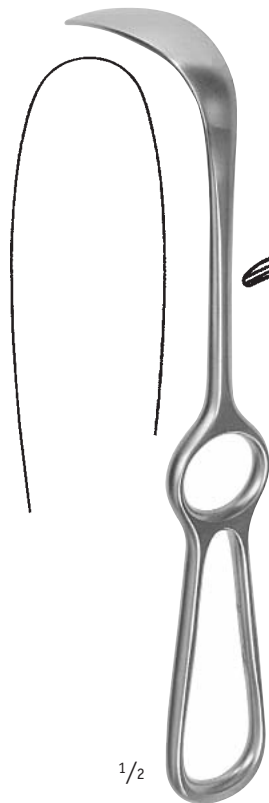
02-20-332

210 mm / 8¹/₄"

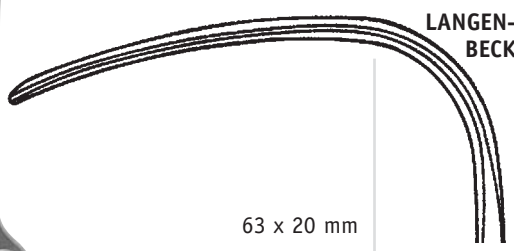
1/2





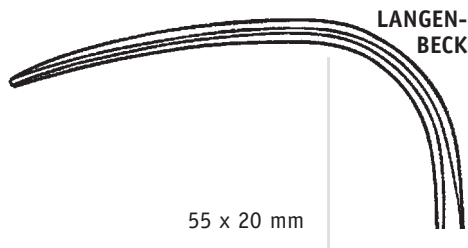

02-20-328

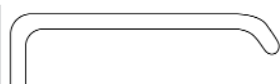

210 mm / 8¹/₄"

02-20-327

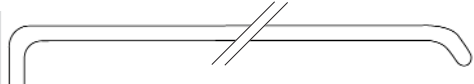
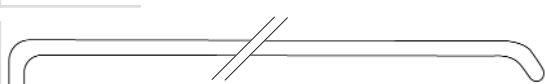
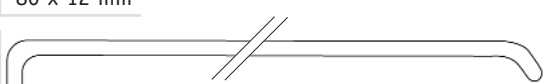
220 mm / 8³/₄"

Artikel-Nr. Cat. No.	Gesamtlänge Total length		
02-20-354	220 mm / 8 ¹ / ₂ "	KOCHER-LANGEN-BECK	 25 x 6 mm
02-20-356	220 mm / 8 ¹ / ₂ "	KOCHER-LANGEN-BECK	 35 x 8 mm
02-20-357	220 mm / 8 ¹ / ₂ "	KOCHER-LANGEN-BECK	 35 x 11 mm
02-20-358	220 mm / 8 ¹ / ₂ "	KOCHER-LANGEN-BECK	 35 x 15 mm
02-20-359	220 mm / 8 ¹ / ₂ "	KOCHER-LANGEN-BECK	 40 x 11 mm
02-20-361	220 mm / 8 ¹ / ₂ "	KOCHER-LANGEN-BECK	 55 x 11 mm
02-20-363	220 mm / 8 ¹ / ₂ "	KOCHER-LANGEN-BECK	 70 x 14 mm
02-20-364	220 mm / 8 ¹ / ₂ "	KOCHER-LANGEN-BECK	 80 x 12 mm
02-20-365	220 mm / 8 ¹ / ₂ "	KOCHER-LANGEN-BECK	 80 x 16 mm

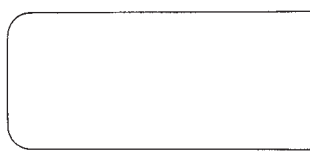

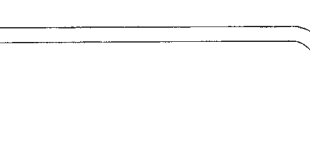
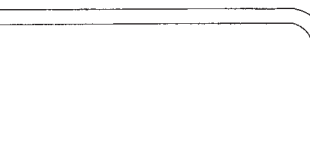
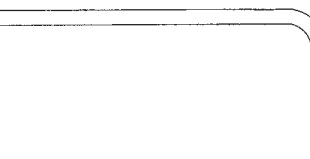
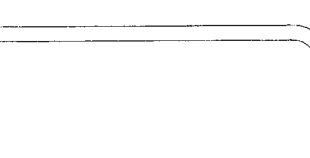
		Artikel-Nr. Cat. No.	Gesamtlänge Total length
  40 x 18 mm	KOCHER	02-20-369	230 mm / 9"
 57 x 25 mm	KOCHER	02-70-368	230 mm / 9"
 60 x 20 mm	KOCHER	02-20-370	230 mm / 9"
 60 x 25 mm	KOCHER	02-20-371	230 mm / 9"
 75 x 30 mm	KOCHER	02-20-372	230 mm / 9"
 78 x 40 mm	KOCHER	02-20-373	230 mm / 9"

1/2

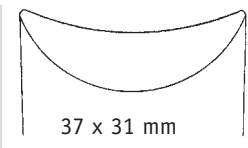
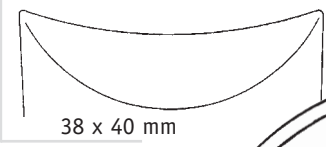
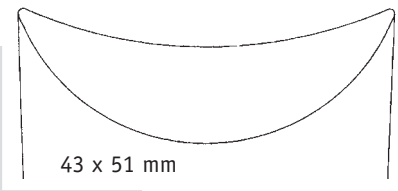
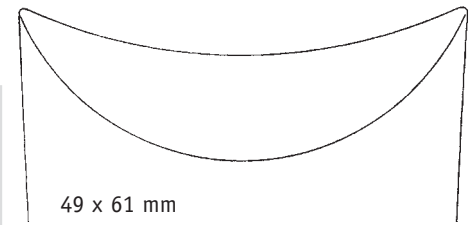
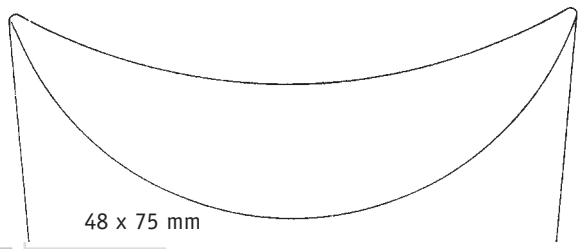
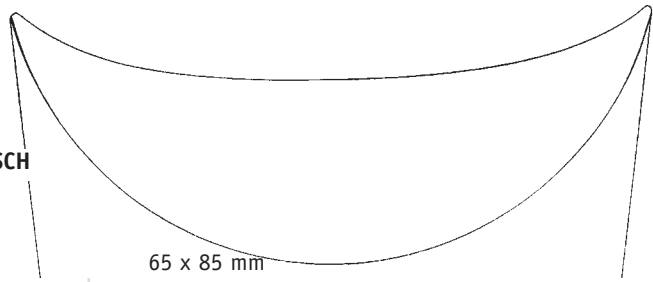
Artikel-Nr. Cat. No.	Gesamtlänge Total length	FRITSCH	
02-70-654	235 mm / 9 ¹ / ₄ "	FRITSCH	 37 x 31 mm
02-20-655	240 mm / 9 ¹ / ₂ "	FRITSCH	 38 x 40 mm
02-20-656	250 mm / 10"	FRITSCH	 43 x 51 mm
02-20-657	250 mm / 10"	FRITSCH	 49 x 61 mm
02-20-658	255 mm / 10"	FRITSCH	 48 x 75 mm
02-20-659	265 mm / 10 ¹ / ₂ "	FRITSCH	 65 x 85 mm

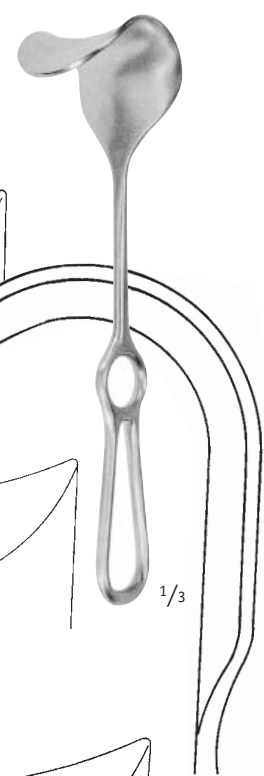

KOCHER

 Artikel-Nr.
 Cat. No.

02-20-460

 Gesamtlänge
 Total length

 225 mm / 8³/₄"

1/2

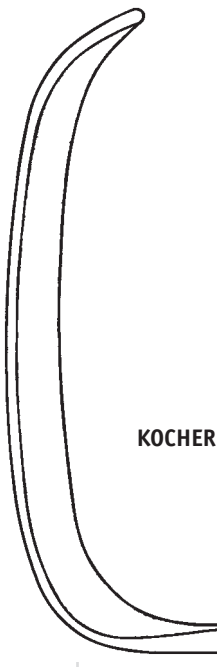
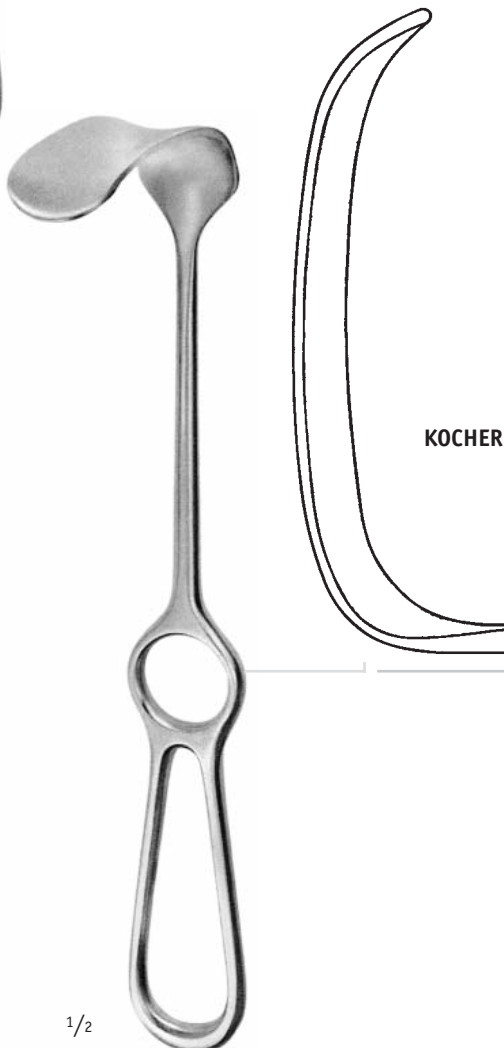
KOCHER
02-20-461

250 mm / 10"

02-20-462

80 x 45 mm

02-20-463

80 x 55 mm

02-70-464

80 x 65 mm

110 x 45 mm

1/2

Artikel-Nr. Cat. No.	Gesamtlänge Total length
02-20-490	280 mm / 11"

**KOCHER
 WAGNER**

22 x 15 mm

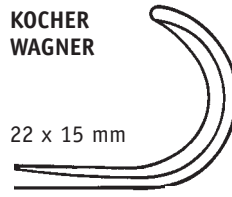

02-20-492	280 mm / 11"
-----------	--------------

**KOCHER
 WAGNER**

38 x 20 mm

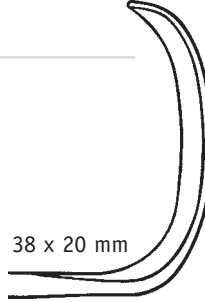

02-20-494	280 mm / 11"
-----------	--------------

**KOCHER
 WAGNER**

67 x 25 mm

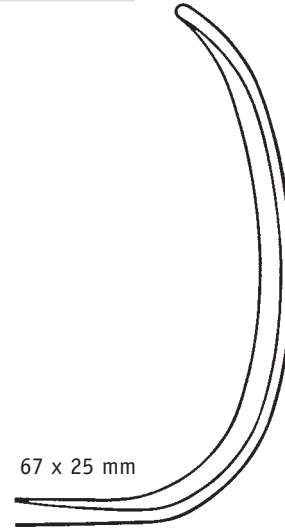

02-20-498	280 mm / 11"
-----------	--------------

**KOCHER
 WAGNER**

100 x 35 mm

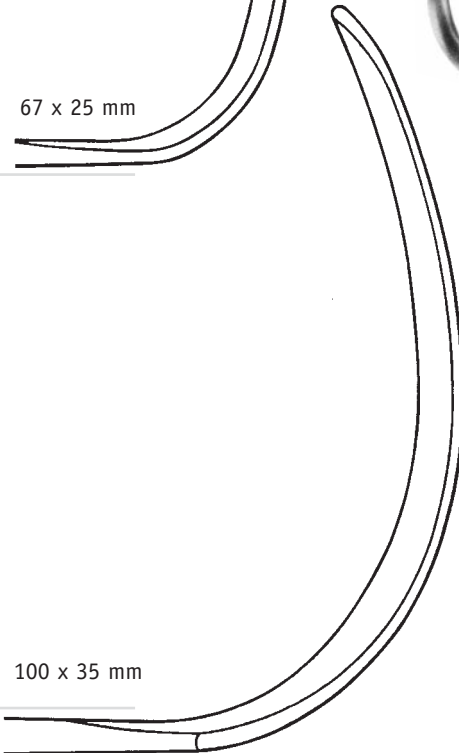

1/2





1/2

MIKULICZ

Artikel-Nr.
Cat. No.

02-20-621

Gesamtlänge
Total length

250 mm /10"

95 x 35 mm ^{1/2}

MIKULICZ

02-20-618

250 mm /10"

85 x 35 mm ^{1/2}

MIKULICZ

02-20-622

250 mm /10"

121 x 50 mm ^{1/2}

MIKULICZ

02-20-623

250 mm /10"

147 x 50 mm ^{1/2}

MIKULICZ

02-20-624

260 mm /10¹/₄"

180 x 50 mm ^{1/2}

Artikel-Nr. Cat. No.	Gesamtlänge Total length
02-20-630	260 mm / 10 ¹ / ₄ "

KELLY
160 x 39 mm^{1/2}

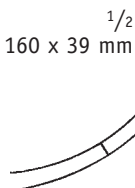

02-20-633	260 mm / 10 ¹ / ₄ "
-----------	---

KELLY

160 x 57 mm^{1/2}

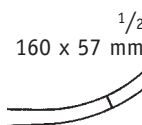

02-70-634	260 mm / 10 ¹ / ₄ "
-----------	---

KELLY

190 x 39 mm^{1/2}

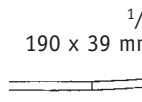

02-70-635	260 mm / 10 ¹ / ₄ "
-----------	---

KELLY

190 x 57 mm^{1/2}

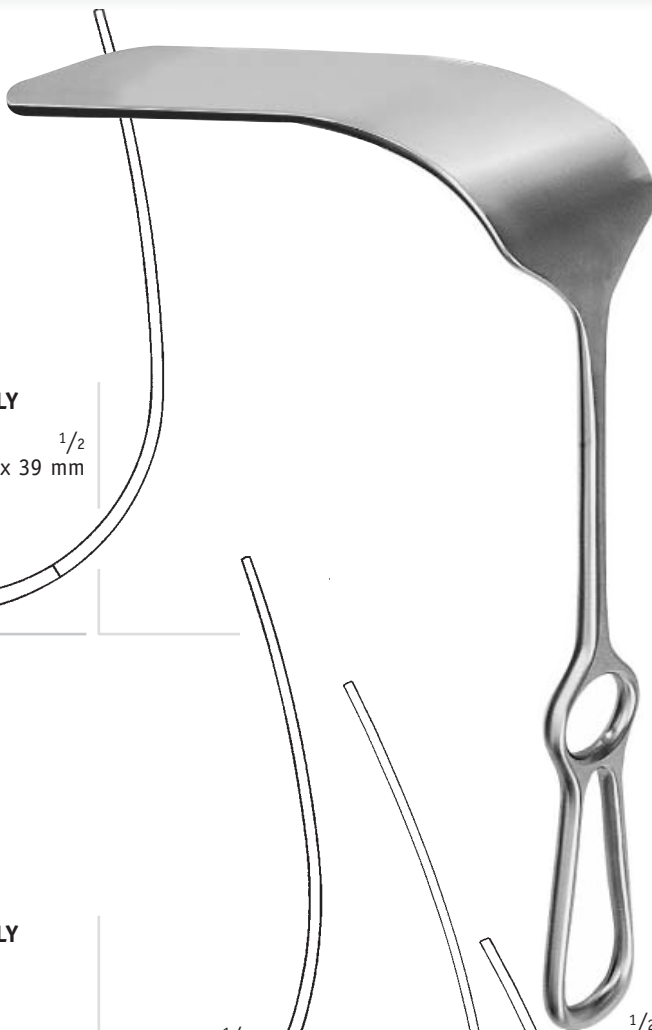
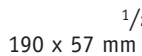



1/3

 $105 \times 27 \text{ mm}$ $\frac{1}{2}$
MARTIN
 Artikel-Nr.
 Cat. No.
05-12-870
 Gesamtlänge
 Total length

250 mm / 10"



1/3

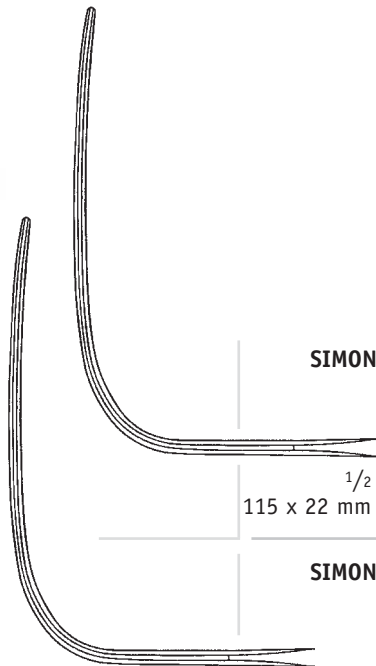

 $115 \times 22 \text{ mm}$ $\frac{1}{2}$
SIMON**05-12-872**

280 mm / 11"

SIMON**05-12-873**

280 mm / 11"

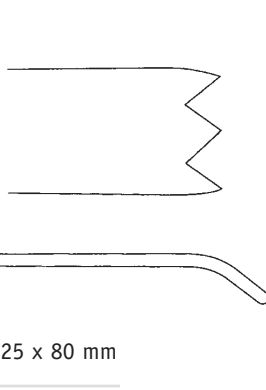
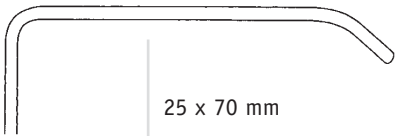
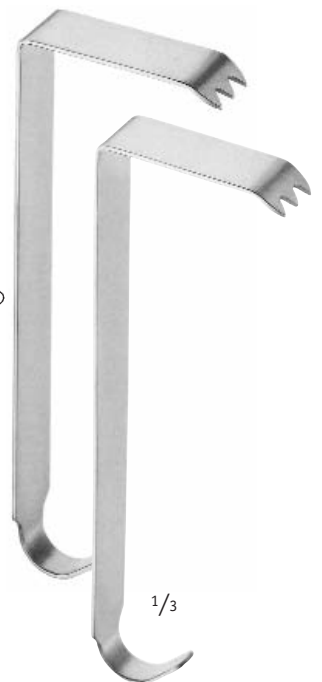
 $115 \times 26 \text{ mm}$ $\frac{1}{2}$

Artikel-Nr. Cat. No.	Gesamtlänge Total length		
02-70-273	240 mm / 9 1/2"	HIBBS	
02-70-274	240 mm / 9 1/2"	HIBBS	
02-70-272	Paar bestehend aus: Pair consisting of: Paire consistante en: Pareja consistente de: Coppia composta di: 02-70-273 - 02-70-274	HIBBS	

02-70-275	205 mm / 8"	TESSIER	
02-70-276	205 mm / 8"	TESSIER	



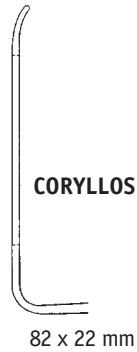

CORYLLOS

 Artikel-Nr.
 Cat. No.

02-20-521

 Gesamtlänge
 Total length
240 mm / 9¹/₂"

1/3

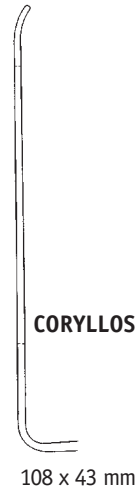
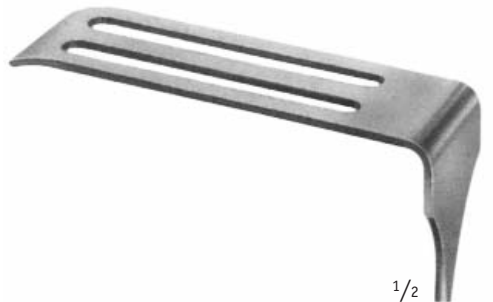

CORYLLOS

02-20-522

240 mm / 9¹/₂"

1/2

108 x 43 mm

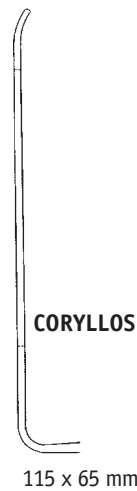
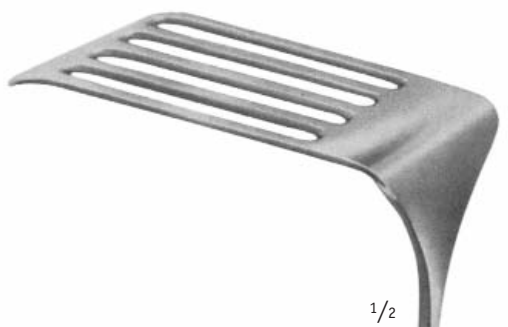





CORYLLOS

02-20-523

240 mm / 9¹/₂"

1/2

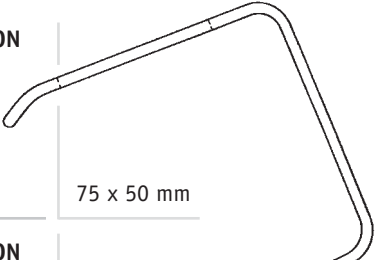
115 x 65 mm

Artikel-Nr. Cat. No.	Gesamtlänge Total length	SAUER- BRUCH	 <p data-bbox="906 658 1026 712">1/2 130 x 38 mm</p>
02-20-514	260 mm / 10 ¹ / ₄ "		
02-20-555	260 mm / 10 ¹ / ₄ " Lungenspatel <i>Lung Spatula</i> <i>Spatule pulmonaire</i> <i>Espátula pulmonare</i> <i>Spatole per polmone</i>		 <p data-bbox="906 1111 1026 1142">205 x 29 mm</p> <p data-bbox="1465 925 1495 956">1/3</p>
02-70-530	195 mm / 7 ³ / ₄ " Scapula Haken <i>Scapula retractor</i> <i>Scapula ecarteur</i> <i>Scapula separador</i> <i>Scapula divaricatori</i>	DAVIDSON	 <p data-bbox="906 1536 1026 1568">75 x 50 mm</p> <p data-bbox="1366 1424 1396 1456">1/3</p>
02-20-531	195 mm / 7 ³ / ₄ " Scapula Haken <i>Scapula retractor</i> <i>Scapula ecarteur</i> <i>Scapula separador</i> <i>Scapula divaricatori</i>	DAVIDSON	 <p data-bbox="906 1727 1026 1780">1/2 75 x 90 mm</p> <p data-bbox="1433 1962 1463 1993">1/3</p>





Bulldogklemmen, Gefäßclips
Bulldog Clamps, Vessel Clips · Clamps Bulldog, Clips vasculaires
Clamps Bulldog, Clips vasculares · Pinze Bulldog, Clips vascolari

// 01

Atraumatische Gefäßklemmen
Atraumatic Vascular Clamps · Pincés vasculaires atraumatiques
Pinzas vasculares atraumáticas · Pinze vascolari atraumatiche

// 02

Atraumatische Pinzetten
Atraumatic Tissue Forceps · Pincés atraumatiques
Pinzas atraumáticas · Pinze atraumatiche

// 03

Rippensperrer
Rib Spreaders · Ecarteurs pour costaux
Separadores costales · Divaricatori costali

// 04

Atrium, Aorta-Instrumente
Atrium-, Aortic Instruments · Instruments pour l'oreillette et l'aorte
Instrumentos para el atrium y la aorta · Strumenti per atrio e aorta

// 05

Wundhaken, Wundspreizer
Retractors · Ecarteurs
Separadores · Divaricatori

// 06

Sonden, Dilatationsinstrumente
Probes, Instruments for dilatation · Sondes, Instruments pour la dilatation
Sondas, Instrumentos para la dilatación · Sonda, Strumenti a dilatazione

// 07

Mikro-Instrumente
Micro Instruments · Micro instruments
Instrumentos para microcirugía · strumenti per microchirurgia

// 08

Allgemeinchirurgische Instrumente
General surgery instruments · Instruments pour la chirurgie générale
Instrumentos para la cirugía general · Strumenti per chirurgia generale

// 09

Orthopädische Instrumente
Orthopaedic Instruments · Instruments pour l'orthopédie
Instrumentos para ortopedia · Strumenti per ortopedia

// 10



Artikel-Nr.
 Cat. No.

NABATOFF
06-02-030

 Krampfader-Besteck, komplett, bestehend aus:
 Varicose vein probe set, complete, consisting of:
 Trousse à varices, complète, composée de:
 Juego para várices, completo, compuesto de:
 Astuccio per varici, completo, composto da:

06-02-033

 Kunststoff-Sondenspitze
 Plastic probe tip · Pointe plastique · Punta
 de sonda de plástico · Punta in materia plastica

06-02-034

 Metall-Sondenspitze
 Metal probe tip · Pointe métallique · Punta
 de sonda de metal · Punta in materia metallo
ø 3 mm
06-02-035

 Metallolive
 Metal olive · Olive métallique
 Oliva de metal · Oliva in materia metallo
ø 6 mm
06-02-036

 Metallolive
 Metal olive · Olive métallique
 Oliva de metal · Oliva in materia metallo
ø 9 mm
06-02-037

 Metallolive
 Metal olive · Olive métallique
 Oliva de metal · Oliva in materia metallo
ø 12 mm
06-02-038

 Metallolive
 Metal olive · Olive métallique
 Oliva de metal · Oliva in materia metallo
ø 15 mm
06-02-040

 Handgriff
 Handle · Manche · Mango · Manico

06-02-032

 Zugseil
 Flexible cable · Cable tracteur, flexible ·
 Cable de tracción, flexible · Caro di trazione, flessibile
900 mm, 30"
06-02-031

 Metalletui
 Metal case · Boîte métal
 Caja metálica · Scatola metallica

Artikel-Nr.
Cat. No.

06-02-050

Krampfader-Besteck, komplett, bestehend aus:
Varicose vein probe set, complete, consisting of:
Trousse à varices, complète, composée de:
Juego para várices, completo, compuesto de:
Astuccio per varici, completo, composto da:

06-02-053

Metallolive
Metal olive · Olive métallique
Oliva de metal · Oliva in materia metallo
ø 3 mm

06-02-054

Metallolive
Metal olive · Olive métallique
Oliva de metal · Oliva in materia metallo
ø 4 mm

06-02-055

Metallolive
Metal olive · Olive métallique
Oliva de metal · Oliva in materia metallo
ø 5 mm

06-02-051

Zugseil, kunststoffummantelt
Flexible cable, polyethylene coated
Cable tracteur, flexible · Cable de tracción, flexible ·
Cavo di trazione, flessibile
450 mm / 17¹/₂"

06-02-031

Metalletui
Metal case · Boîte métal
Caja metálica · Scatola metallica

VARADY



3 mm



4 mm





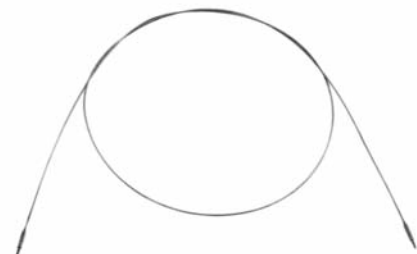



5 mm



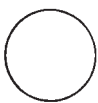
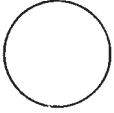

	Artikel-Nr. Cat. No.	Gesamtlänge Total length
○ ø 2 mm	06-02-108	500 mm / 20"
○ ø 3 mm	06-02-109	500 mm / 20"
○ ø 4 mm	06-02-110	500 mm / 20"
○ ø 6 mm	06-02-112	500 mm / 20"
○ ø 7 mm	06-02-113	500 mm / 20"
○ ø 8,5 mm	06-02-114	500 mm / 20"
○ ø 10 mm	06-02-115	500 mm / 20"
○ ø 12 mm	06-02-116	500 mm / 20"
○ ø 14 mm	06-02-117	500 mm / 20"

Artikel-Nr. Cat. No.	Gesamtlänge Total length		
06-52-008	500 mm / 20"	 ø 2 mm	
06-52-010	500 mm / 20"	 ø 4 mm	
06-52-012	500 mm / 20"	 ø 6 mm	
06-52-013	500 mm / 20"	 ø 7 mm	
06-52-014	500 mm / 20"	 ø 8,5 mm	
06-52-015	500 mm / 20"	 ø 10 mm	
06-52-016	500 mm / 20"	 ø 12 mm	
06-52-017	500 mm / 20"	 ø 14 mm	

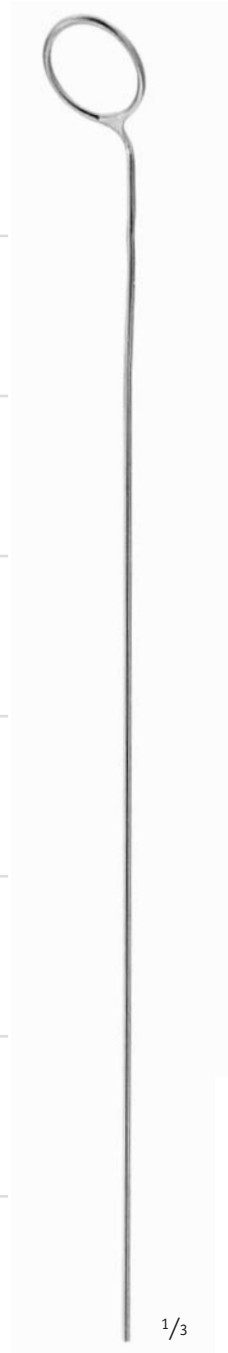

1/3

06-02-119	120 mm / 4 1/4" Griff für Endarterektomie-Stripper Handle for endarterectomy strippers Manche pour désoblitérateurs pour endartérectomie Mango para disectores para endarterectomía Manico per disobliteratori per endarterectomia		
-----------	---	--	--



2/3



1/2

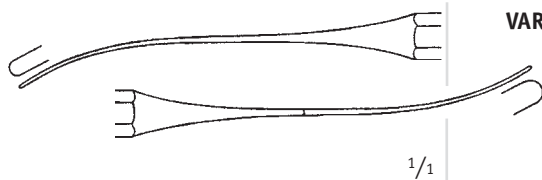

1/1

VARADY

 Artikel-Nr.
 Cat. No.

06-02-120

 Gesamtlänge
 Total length

180 mm / 7"

 Phlebo-dissektor
 Phlebo-dissector
 Phlebo-dissecteur
 Flebo-dissecador
 Flebo-dissettore

1/2



1/1

VARADY

06-02-121

180 mm / 7"

 Phlebo-extraktor
 Phlebo-extractor
 Phlebo-extracteur
 Flebo-extractor
 Flebo-extrattore

1/2



1/1

VARADY

06-02-122

180 mm / 7"

 Phlebo-extraktor
 Phlebo-extractor
 Phlebo-extracteur
 Flebo-extractor
 Flebo-extrattore

Artikel-Nr. Cat. No.	Gesamtlänge Total length
06-02-124	180 mm / 7"

Mikro-Dissektor
 Micro Dissector
 Micro dissector
 Micro disecador
 Micro-dissettore

VARADY

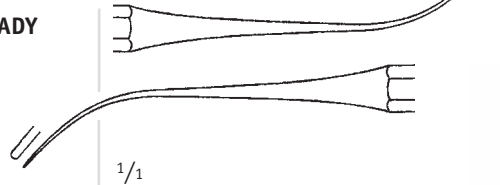

06-02-125	180 mm / 7"
------------------	-------------

Mikro-Phleboextraktor
 Micro-Phleboextractor
 Micro-Phleboextracteur
 Micro-Fleboextractor
 Micro-Fleboestrattore

VARADY

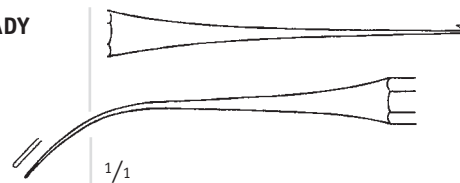







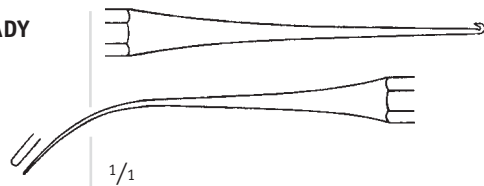

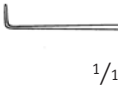

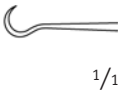

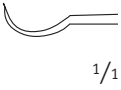

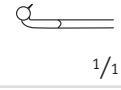

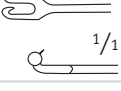

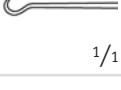
06-02-126	180 mm / 7"
------------------	-------------

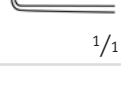
Mikro-Phleboextraktor
 Micro-Phleboextractor
 Micro-Phleboextracteur
 Micro-Fleboextractor
 Micro-Fleboestrattore

VARADY



		Artikel-Nr. Cat. No.	Gesamtlänge Total length	
		CAIRNS	06-06-313	130 mm / 5 ¹ / ₈ "
	1/1			
		FRAZIER	06-06-321	130 mm / 5 ¹ / ₈ "
	1/1			
		TOENNIS	06-06-322	150 mm / 6"
	1/1			
		MÜLLER	15-12-626	150 mm / 6"
	1/1			
		MÜLLER	15-12-627	150 mm / 6"
	1/1			
		GILLIES	15-12-611	180 mm / 7"
	1/1			
		GILLIES	15-12-612	180 mm / 7"
	1/1			
		COTTLE	15-12-619	160 mm / 6 ¹ / ₄ "
	1/1			
		CUSHING	02-20-082	190 mm / 7 ¹ / ₂ "
	1/1		02-70-084	280 mm / 7 ¹ / ₂ "
		CUSHING	02-20-083	190 mm / 7 ¹ / ₂ "
	1/1		02-20-084	280 mm / 7 ¹ / ₂ "

Artikel-Nr. Cat. No.	Gesamtlänge Total length		
06-04-396	185 mm / 7 ¹ / ₄ " Nerv- und Gefäßhäkchen Nerve and vessel hook · Crochet pour nerfs et vaisseaux · Gancho para nervios y vasos · Unicini per nervi e vasi	KRAYEN-BÜHL	 1/1
06-04-397	185 mm / 7 ¹ / ₄ " Nerv- und Gefäßhäkchen Nerve and vessel hook · Crochet pour nerfs et vaisseaux · Gancho para nervios y vasos · Unicini per nervi e vasi	KRAYEN-BÜHL	 1/1
06-04-398	185 mm / 7 ¹ / ₄ " Nerv- und Gefäßhäkchen Nerve and vessel hook · Crochet pour nerfs et vaisseaux · Gancho para nervios y vasos · Unicini per nervi e vasi	KRAYEN-BÜHL	 1/1
06-04-399	185 mm / 7 ¹ / ₄ " Nerv- und Gefäßhäkchen Nerve and vessel hook · Crochet pour nerfs et vaisseaux · Gancho para nervios y vasos · Unicini per nervi e vasi	KRAYEN-BÜHL	 1/1



1/1



2/3

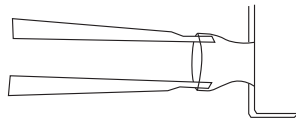

 Artikel-Nr.
 Cat. No.

 Gesamtlänge
 Total length

06-54-313

110 mm / 4³/₈"

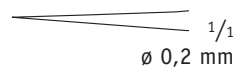
06-54-314

110 mm / 4³/₈"

06-54-315

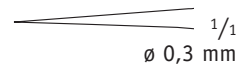
135 mm / 5¹/₄"

06-54-316

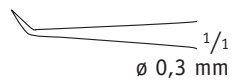

135 mm / 5¹/₄"

2/3



06-54-317

135 mm / 5¹/₄"

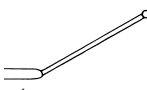
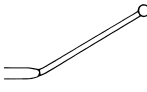
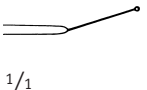
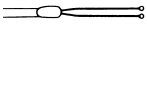
Artikel-Nr. Cat. No.	Gesamtlänge Total length		
06-04-310	160 mm / 6 ¹ / ₄ "	BIEMER	 2/1
	Gefäßspreizer Vessel Spreader · Ecarteur pour vaisseaux Separador para vasos · Divaricatore per vasi		
06-04-306	125 mm / 5"		 1/1 ø 0,5 mm
	Gefäßdilator Vessel Dilator · Dilatateur vasculaire Dilatador vascular · Dilatatore vascolare		
06-04-307	125 mm / 5"		 1/1 ø 1 mm
	Gefäßdilator Vessel Dilator · Dilatateur vasculaire Dilatador vascular · Dilatatore vascolare		
06-04-308	125 mm / 5"		 1/1 ø 1,5 mm
	Gefäßdilator Vessel Dilator · Dilatateur vasculaire Dilatador vascular · Dilatatore vascolare		
06-04-311	185 mm / 7 ¹ / ₄ "	JACOBSON	 1/1
	Knopfsonde Buttoned probe · Sonde boutonnée Sonda abotonada · Sonde bottonute		
06-04-312	185 mm / 7 ¹ / ₄ "	JACOBSON	 1/1
	Doppelsonde Twin Probe · Sonde double · Sonda doble · Sonda doppia		



1/1



1/1

	Artikel-Nr. Cat. No.	Gesamtlänge Total length
 $\frac{1}{1}$ 4,5 mm	CASPAR 06-06-303	230 mm / 9"
 $\frac{1}{1}$ 2 mm	06-04-333	230 mm / 9"
 $\frac{1}{1}$ 1,8 mm	06-04-334	230 mm / 9"
 $\frac{1}{1}$ 1,4 mm	06-04-332	230 mm / 9"
 $\frac{1}{1}$ 1 mm	OPPEL 06-04-429	230 mm / 9"
 $\frac{1}{1}$ 1 mm	CASPAR 06-06-310	200 mm / 8"
 $\frac{1}{1}$ 3 mm	06-02-150	185 mm / 7 $\frac{1}{4}$ "
 $\frac{1}{1}$ 3 mm	06-02-151	215 mm / 8 $\frac{1}{2}$ "
 $\frac{1}{1}$	YASARGIL 06-04-302	185 mm / 7 $\frac{1}{4}$ "

Artikel-Nr. Cat. No.	Gesamtlänge Total length
06-06-301	240 mm / 9 ¹ / ₂ " stumpf - stumpf blunt - blunt mousse - mousse romo - romo smusso - smusso
06-06-302	240 mm / 9 ¹ / ₂ " stumpf - stumpf blunt - blunt mousse - mousse romo - romo smusso - smusso

TOENNIS

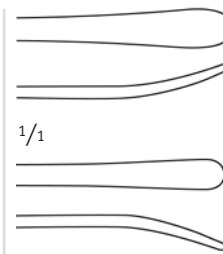

TOENNIS

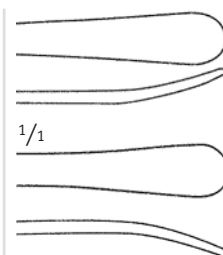

1/2

06-06-349	230 mm / 9" Sonde & Dissektor Probe & Dissector Sonde & Dissecteur Sonda & Disecador Sonda & Dissettori
------------------	--

PENNY-BACKER

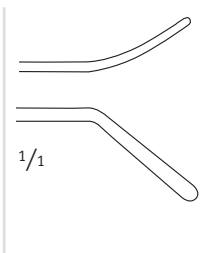

1/2



1/2



1/2

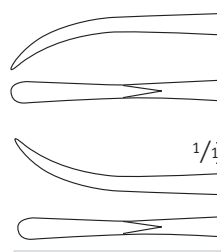

**FREER-
YASARGIL**

 Artikel-Nr.
 Cat. No.

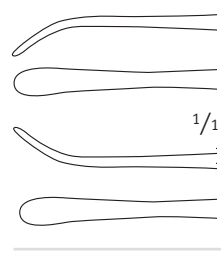
15-12-166

 Gesamtlänge
 Total length
185 mm / 7¹/₄"
 scharf - scharf
 sharp - sharp
 pointue - pointue
 aguda - aguda
 acuta - acuta
**FREER**

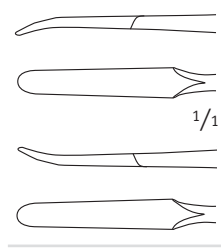
15-12-165

185 mm / 7¹/₄"
 scharf - stumpf
 sharp - blunt
 pointue - mousse
 aguda - romo
 acuta - smusso
**KILLIAN**

15-12-170

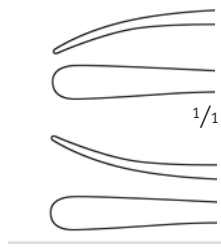
185 mm / 7¹/₄"
 scharf - stumpf
 sharp - blunt
 pointue - mousse
 aguda - romo
 acuta - smusso
**DAVIS**

06-06-300

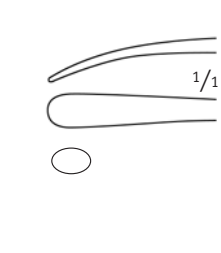
245 mm / 9³/₄"
 scharf - stumpf
 sharp - blunt
 pointue - mousse
 aguda - romo
 acuta - smusso
**FREER**

15-12-162

190 mm / 7¹/₂"
 scharf
 sharp · pointue
 aguda · acuta

15-12-163

190 mm / 7¹/₂"
 stumpf
 blunt · mousse
 romo · smusso



Artikel-Nr.
 Cat. No.

Spreizweite
 Blade opening

06-02-682

8 - 42 mm

TUBBS



1/2

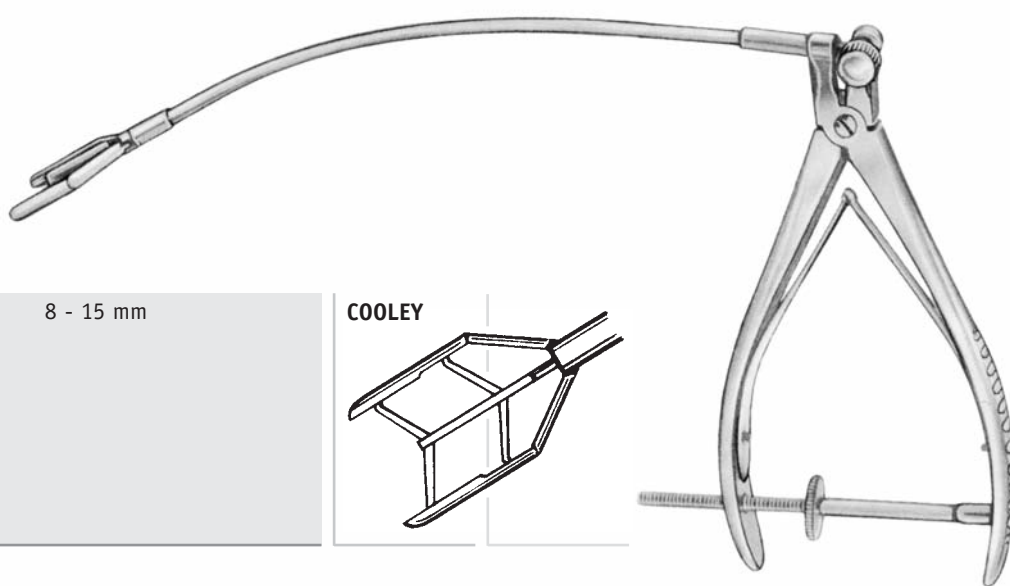





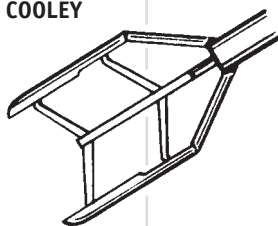

06-52-680







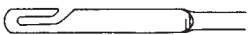

8 - 15 mm

COOLEY



1/2

		Artikel-Nr. Cat. No.	Gesamtlänge Total length
 1/3	RUMEL-BELMONT	06-02-651	330 mm / 13" ø 3,2 mm flexibel · flexible · flexible · flexible · flessibili
		06-02-652	330 mm / 13" ø 6,4 mm flexibel · flexible · flexible · flexible · flessibili
	 1/3	06-02-653	ø 3,2 mm Mandrin alleine zu 06-02-651 guide only for 06-02-651 · mandrin seul pour 06-02-651 mandril solo para 06-02-651 · mandrino solo per 06-02-651
		06-02-654	ø 6,4 mm Mandrin alleine zu 06-02-652 guide only for 06-02-652 · mandrin seul pour 06-02-652 mandril solo para 06-02-652 · mandrino solo per 06-02-652
 1/3	 1,5 mm	06-52-650	260 mm / 10 ¹ / ₂ " Fadenfänger <i>Ligature catcher · Porte-ligatures</i> <i>Porta ligaduras · Porta-legature</i>
	 2,0 mm	06-52-651	260 mm / 10 ¹ / ₂ " Fadenfänger <i>Ligature catcher · Porte-ligatures</i> <i>Porta ligaduras · Porta-legature</i>
	 2,5 mm	06-52-652	260 mm / 10 ¹ / ₂ " Fadenfänger <i>Ligature catcher · Porte-ligatures</i> <i>Porta ligaduras · Porta-legature</i>
	 3,0 mm	06-52-653	260 mm / 10 ¹ / ₂ " Fadenfänger <i>Ligature catcher · Porte-ligatures</i> <i>Porta ligaduras · Porta-legature</i>







Artikel-Nr. Cat. No.	Gesamtlänge Total length		
06-52-150	130 mm / 5" biegsam malleable · malléable · maleable · maleabili	COOLEY	 ø 0,5 mm
06-52-151	130 mm / 5" biegsam malleable · malléable · maleable · maleabili	COOLEY	 ø 1,0 mm
06-52-152	130 mm / 5" biegsam malleable · malléable · maleable · maleabili	COOLEY	 ø 1,5 mm
06-52-153	130 mm / 5" biegsam malleable · malléable · maleable · maleabili	COOLEY	 ø 2,0 mm
06-52-154	130 mm / 5" biegsam malleable · malléable · maleable · maleabili	COOLEY	 ø 2,5 mm
06-52-155	130 mm / 5" biegsam malleable · malléable · maleable · maleabili	COOLEY	 ø 3,0 mm
06-52-156	130 mm / 5" biegsam malleable · malléable · maleable · maleabili	COOLEY	 ø 4,0 mm
06-52-157	130 mm / 5" biegsam malleable · malléable · maleable · maleabili	COOLEY	 ø 5,0 mm



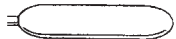

1/1

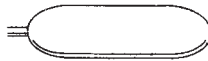

		Artikel-Nr. Cat. No.	Gesamtlänge Total length
 ø 0,5 mm	DE BAKEY	06-02-160	190 mm / 7 ¹ / ₂ "
		06-52-160	350 mm / 14"
biegsam <i>malleable · malléable · maleable · maleabili</i>			
 ø 1,0 mm	DE BAKEY	06-02-161	190 mm / 7 ¹ / ₂ "
		06-52-161	350 mm / 14"
biegsam <i>malleable · malléable · maleable · maleabili</i>			
 ø 1,5 mm	DE BAKEY	06-02-162	190 mm / 7 ¹ / ₂ "
		06-52-162	350 mm / 14"
biegsam <i>malleable · malléable · maleable · maleabili</i>			
 ø 2,0 mm	DE BAKEY	06-02-163	190 mm / 7 ¹ / ₂ "
		06-52-163	350 mm / 14"
biegsam <i>malleable · malléable · maleable · maleabili</i>			
 ø 2,5 mm	DE BAKEY	06-02-164	190 mm / 7 ¹ / ₂ "
		06-52-164	350 mm / 14"
biegsam <i>malleable · malléable · maleable · maleabili</i>			
 ø 3,0 mm	DE BAKEY	06-02-165	190 mm / 7 ¹ / ₂ "
		06-52-165	350 mm / 14"
biegsam <i>malleable · malléable · maleable · maleabili</i>			

Artikel-Nr. Cat. No.	Gesamtlänge Total length		
06-02-166	190 mm / 7 ¹ / ₂ "	DE BAKEY	 ø 3,5 mm
06-52-166	350 mm / 14"		
	biegsam malleable · malléable · maleable · maleabili		
06-02-167	190 mm / 7 ¹ / ₂ "	DE BAKEY	 ø 4,0 mm
06-52-167	350 mm / 14"		
	biegsam malleable · malléable · maleable · maleabili		
06-02-168	190 mm / 7 ¹ / ₂ "	DE BAKEY	 ø 4,5 mm
06-52-168	350 mm / 14"		
	biegsam malleable · malléable · maleable · maleabili		
06-02-169	190 mm / 7 ¹ / ₂ "	DE BAKEY	 ø 5,0 mm
06-52-169	350 mm / 14"		
	biegsam malleable · malléable · maleable · maleabili		
06-02-170	190 mm / 7 ¹ / ₂ "	DE BAKEY	 ø 7,0 mm
06-52-170	350 mm / 14"		
	biegsam malleable · malléable · maleable · maleabili		
06-02-172	190 mm / 7 ¹ / ₂ "	DE BAKEY	 ø 9,0 mm
06-52-172	350 mm / 14"		
	biegsam malleable · malléable · maleable · maleabili		

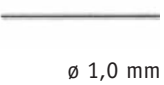
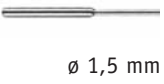
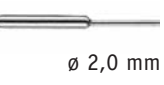
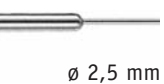
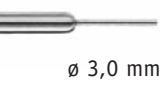
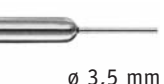
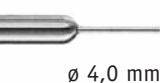
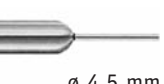

		Artikel-Nr. Cat. No.	Gesamtlänge Total length
	GARRETT	06-52-181 06-52-191	140 mm / 5 ¹ / ₂ " 210 mm / 8 ¹ / ₄ " biegsam malleable · malléable · maleable · maleabili
	GARRETT	06-52-182 06-52-192	140 mm / 5 ¹ / ₂ " 210 mm / 8 ¹ / ₄ " biegsam malleable · malléable · maleable · maleabili
	GARRETT	06-52-183 06-52-193	140 mm / 5 ¹ / ₂ " 210 mm / 8 ¹ / ₄ " biegsam malleable · malléable · maleable · maleabili
	GARRETT	06-52-184 06-52-194	140 mm / 5 ¹ / ₂ " 210 mm / 8 ¹ / ₄ " biegsam malleable · malléable · maleable · maleabili
	GARRETT	06-52-185 06-52-195	140 mm / 5 ¹ / ₂ " 210 mm / 8 ¹ / ₄ " biegsam malleable · malléable · maleable · maleabili
	GARRETT	06-52-186 06-52-196	140 mm / 5 ¹ / ₂ " 210 mm / 8 ¹ / ₄ " biegsam malleable · malléable · maleable · maleabili
	GARRETT	06-52-187 06-52-197	140 mm / 5 ¹ / ₂ " 210 mm / 8 ¹ / ₄ " biegsam malleable · malléable · maleable · maleabili
	GARRETT	06-52-188 06-52-198	140 mm / 5 ¹ / ₂ " 210 mm / 8 ¹ / ₄ " biegsam malleable · malléable · maleable · maleabili
	GARRETT	06-52-189 06-52-199	140 mm / 5 ¹ / ₂ " 210 mm / 8 ¹ / ₄ " biegsam malleable · malléable · maleable · maleabili
	GARRETT	06-52-180 06-52-190	140 mm / 5 ¹ / ₂ " 210 mm / 8 ¹ / ₄ " Satz mit 9 Stück Set of 9 pieces · Jeu de 9 pièces Juego de 9 piezas · Serie di 9 pezzi von · from · de · de · da 1,0 - 5,0 mm

1/1



Artikel-Nr.
 Cat. No.

Gesamtlänge
 Total length

10-57-001

50 x 100 mm

10-57-002

50 x 130 mm

10-57-003

50 x 175 mm

Standgefäße
 Dilator & instrument jars · Récipient métallique
 Recipiente metálico · Recipienti metallici



1/2

ø 15 mm

06-52-175

500 mm / 20"

DE BAKEY

biegsam
 malleable · malléable · maleable · maleabili



1/2



1/2

 Artikel-Nr.
 Cat. No.

HEGAR	05-63-001	Satz mit 8 Stück, ohne Etui <i>set of 8 pieces, without case</i> <i>jeu de 8 pièces, sans boîte</i> <i>juego de 8 piezas, sin caja</i> <i>serie di 8 pezzi, senza scatola</i> von · from · de · de · da 3,0 / 4,0 - 17,0 / 18,0 mm 05-13-232 - 05-13-239
HEGAR	05-63-002	Satz mit 13 Stück, ohne Etui <i>set of 13 pieces, without case</i> <i>jeu de 13 pièces, sans boîte</i> <i>juego de 13 piezas, sin caja</i> <i>serie di 13 pezzi, senza scatola</i> von · from · de · de · da 1,0 / 2,0 - 25,0 / 26,0 mm 05-13-231 - 05-63-025

 Artikel-Nr.
 Cat. No.

 Gesamtlänge
 Total length

HEGAR	205 mm / 8"
05-13-231	∅ 1 / 2 mm
05-13-232	∅ 3 / 4 mm
05-13-233	∅ 5 / 6 mm
05-13-234	∅ 7 / 8 mm
05-13-235	∅ 9 / 10 mm
05-13-236	∅ 11 / 12 mm
05-13-237	∅ 13 / 14 mm
05-13-238	∅ 15 / 16 mm
05-13-239	∅ 17 / 18 mm
05-63-019	∅ 19 / 20 mm
05-63-021	∅ 21 / 22 mm
05-63-023	∅ 23 / 24 mm
05-63-025	∅ 25 / 26 mm

Artikel-Nr.
 Cat. No.

05-63-010

Satz mit 14 Stück, ohne Etui
set of 14 pieces, without case
jeu de 14 pièces, sans boîte
juego de 14 piezas, sin caja
serie di 14 pezzi, senza scatola
 von · from · de · de · da **4,0 - 17,0 mm**
05-13-104 - 05-13-117

HEGAR

05-63-011

Satz mit 26 Stück, ohne Etui
set of 26 pieces, without case
jeu de 26 pièces, sans boîte
juego de 26 piezas, sin caja
serie di 26 pezzi, senza scatola
 von · from · de · de · da **1,0 - 26,0 mm**
05-13-101 - 05-13-126

HEGAR



1/2

Artikel-Nr.
 Cat. No.

Gesamtlänge
 Total length

HEGAR

185 mm / 7¹/₄"

05-13-101
05-13-102
05-13-103
05-13-104
05-13-105
05-13-106
05-13-107
05-13-108
05-13-109
05-13-110
05-13-111
05-13-112
05-13-113
05-13-114
05-13-115
05-13-116
05-13-117
05-13-118
05-13-119
05-13-120
05-13-121
05-13-122
05-13-123
05-13-124

Ø 1 mm
 Ø 2 mm
 Ø 3 mm
 Ø 4 mm
 Ø 5 mm
 Ø 6 mm
 Ø 7 mm
 Ø 8 mm
 Ø 9 mm
 Ø 10 mm
 Ø 11 mm
 Ø 12 mm
 Ø 13 mm
 Ø 14 mm
 Ø 15 mm
 Ø 16 mm
 Ø 17 mm
 Ø 18 mm
 Ø 19 mm
 Ø 20 mm
 Ø 21 mm
 Ø 22 mm
 Ø 23 mm
 Ø 24 mm

Artikel-Nr.
 Cat. No.

Gesamtlänge
 Total length

HEGAR

185 mm / 7¹/₄"

05-13-125
05-13-126
05-13-127
05-13-128
05-13-129
05-13-130

05-13-131
05-13-132
05-13-133
05-13-134
05-13-135
05-13-136
05-13-137
05-13-138
05-13-139
05-13-140
05-13-141
05-13-142
05-13-143
05-13-144
05-13-145
05-13-146
05-13-147

Ø 25 mm
 Ø 26 mm
 Ø 27 mm
 Ø 28 mm
 Ø 29 mm
 Ø 30 mm

 Ø 1,5 mm
 Ø 2,5 mm
 Ø 3,5 mm
 Ø 4,5 mm
 Ø 5,5 mm
 Ø 6,5 mm
 Ø 7,5 mm
 Ø 8,5 mm
 Ø 9,5 mm
 Ø 10,5 mm
 Ø 11,5 mm
 Ø 12,5 mm
 Ø 13,5 mm
 Ø 14,5 mm
 Ø 15,5 mm
 Ø 16,5 mm
 Ø 17,5 mm

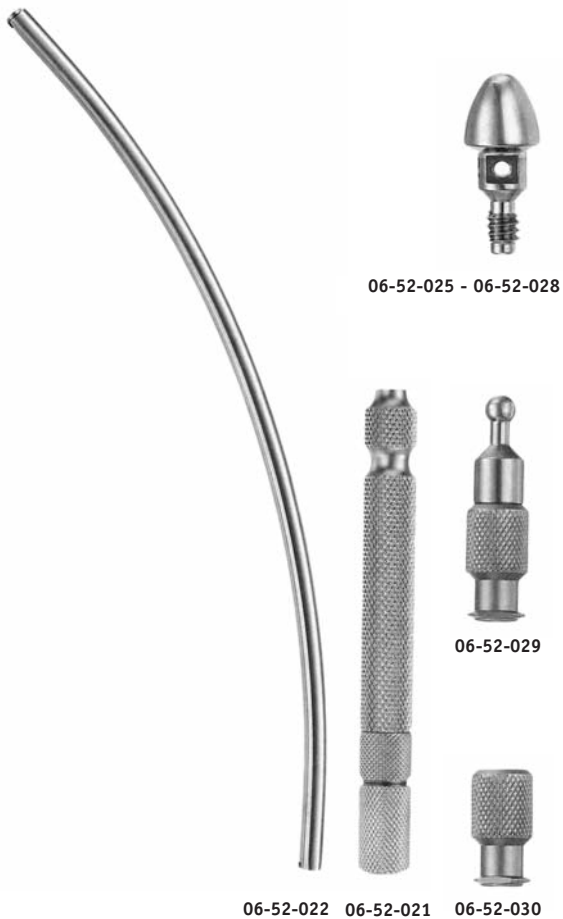
 Artikel-Nr.
 Cat. No.

 Gesamtlänge
 Total length

06-52-020

 Satz, komplett, bestehend aus:
 Set, complete, consisting of:
 Jeu, complète, composée de:
 Juego, completo, compuesto de:
 Serie, completo, composto da:

06-52-021

 Griff Universal (2x)
 Universal Handle · Manche universel
 Mango universal · Manico universale
125 mm

06-52-022

 Schaft gebogen (1x)
 Shaft curved · Tige courbe
 Vastago curvo · Asta curva
225 mm

06-52-023

 Schaft gerade (1x)
 Shaft straight · Tige droite
 Vastago recto · Asta diritta
225 mm

06-52-024

 Schaft gebogen (1x)
 Shaft curved · Tige courbe
 Vastago curvo · Asta curva
540 mm

06-52-025

 Schraubolive (2x)
 Screw Olive · Olive
 Oliva · Oliva
ø 6 mm

06-52-026

 Schraubolive (2x)
 Screw Olive · Olive
 Oliva · Oliva
ø 8 mm

06-52-027

 Schraubolive (2x)
 Screw Olive · Olive
 Oliva · Oliva
ø 10 mm

06-52-028

 Schraubolive (2x)
 Screw Olive · Olive
 Oliva · Oliva
ø 12 mm

06-52-029

 Venen-Aufsatz (1x)
 Vein Tip · Pointe à veines
 Cono para venas · Testa adattatore veni

06-52-030

 Luer Adapter (1x)
 Luer Adaptor · Raccord Luer
 Cabeza adaptador Luer · Luer adattatore

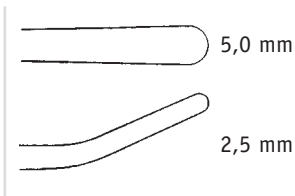
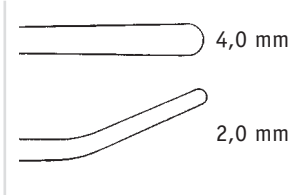
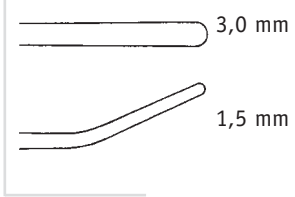
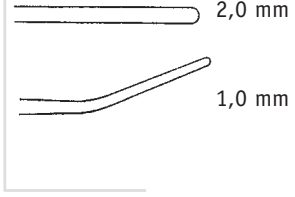
Artikel-Nr. Cat. No.	Gesamtlänge Total length	ROBB	
06-52-040	240 mm / 10"	ROBB	 <p>5,0 mm 2,5 mm</p>
06-52-041	240 mm / 10"	ROBB	 <p>4,0 mm 2,0 mm</p>
06-52-042	240 mm / 10"	ROBB	 <p>3,0 mm 1,5 mm</p>
06-52-043	240 mm / 10"	ROBB	 <p>2,0 mm 1,0 mm</p>





1/2



1/1

SCHMID
 Artikel-Nr.
 Cat. No.
06-02-158
 Gesamtlänge
 Total length
140 mm / 5¹/₂"
 stumpf
 blunt · mousse · romo · smusso

1/1

SCHMID**06-02-159**

235 mm / 9"

 stumpf
 blunt · mousse · romo · smusso

Artikel-Nr. Cat. No.	Gesamtlänge Total length		
02-64-001	115 mm / 4 ¹ / ₂ "		
02-14-003	130 mm / 5"		
02-14-004	145 mm / 5 ³ / ₄ "		
02-14-006	160 mm / 6 ¹ / ₄ "		
02-64-002	180 mm / 7"		
02-64-003	300 mm / 12"		
	gerade straight · droite · recto · dritto		
02-14-010	140 mm / 5 ¹ / ₂ "	DOYEN	
	gebogen curved · courbe · curva · curve		
02-64-004	130 mm / 5"		
02-14-015	140 mm / 5 ¹ / ₂ "		
02-64-005	180 mm / 7"		

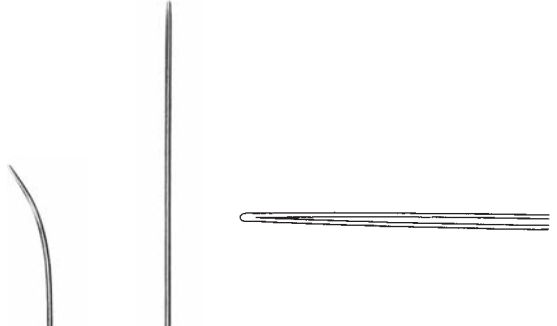
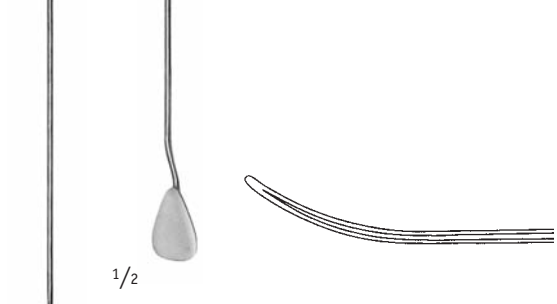
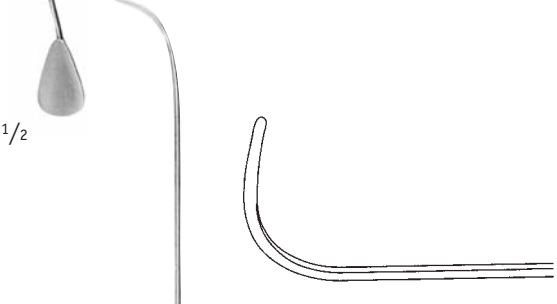
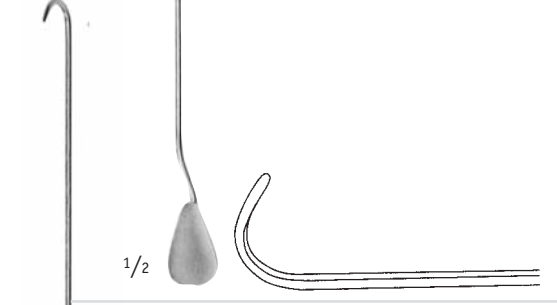

	LOCKHART-MUMMERY	Artikel-Nr. Cat. No.	Gesamtlänge Total length
		02-14-021	160 mm / 6 ¹ / ₄ " Fig. 1
	LOCKHART-MUMMERY	02-14-022	160 mm / 6 ¹ / ₄ " Fig. 2
	LOCKHART-MUMMERY	02-14-023	160 mm / 6 ¹ / ₄ " Fig. 3
	LOCKHART-MUMMERY	02-14-024	160 mm / 6 ¹ / ₄ " Fig. 4

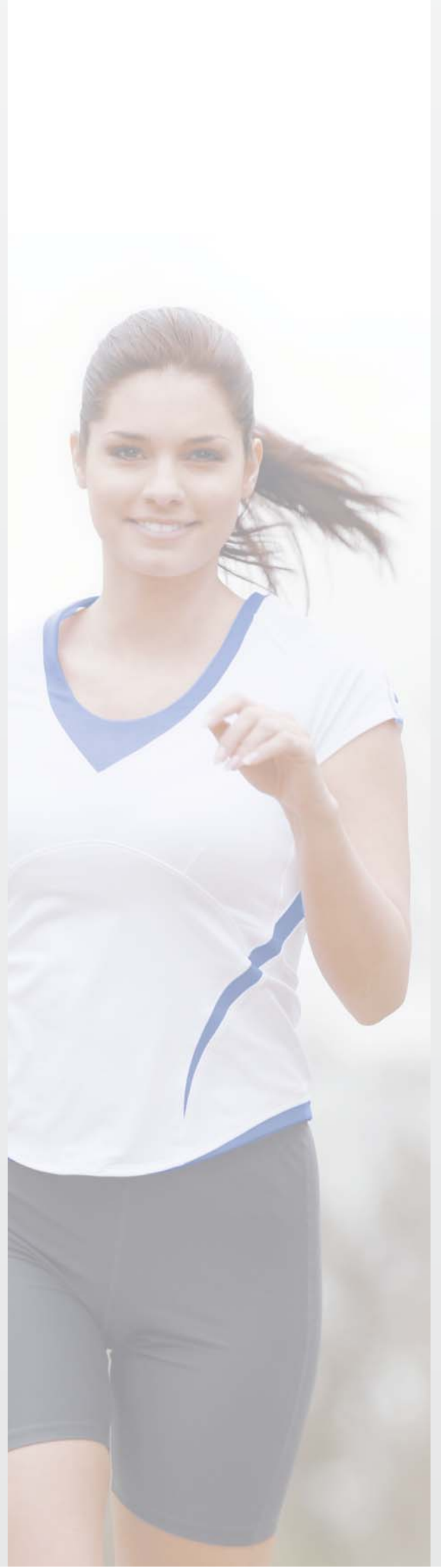

Bulldogklemmen, Gefäßclips
Bulldog Clamps, Vessel Clips · Clamps Bulldog, Clips vasculaires
Clamps Bulldog, Clips vasculares · Pinze Bulldog, Clips vascolari

// 01

Atraumatische Gefäßklemmen
Atraumatic Vascular Clamps · Pincés vasculaires atraumatiques
Pinzas vasculares atraumáticas · Pinze vascolari atraumatiche

// 02

Atraumatische Pinzetten
Atraumatic Tissue Forceps · Pincés atraumatiques
Pinzas atraumáticas · Pinze atraumatiche

// 03

Rippensperrer
Rib Spreaders · Ecarteurs pour costaux
Separadores costales · Divaricatori costali

// 04

Atrium, Aorta-Instrumente
Atrium-, Aortic Instruments · Instruments pour l'oreillette et l'aorte
Instrumentos para el atrium y la aorta · Strumenti per atrio e aorta

// 05

Wundhaken, Wundspreizer
Retractors · Ecarteurs
Separadores · Divaricatori

// 06

Sonden, Dilatationsinstrumente
Probes, Instruments for dilatation · Sondes, Instruments pour la dilatation
Sondas, Instrumentos para la dilatación · Sonda, Strumenti a dilatazione

// 07

Mikro-Instrumente
Micro Instruments · Micro instruments
Instrumentos para microcirugía · strumenti per microchirurgia

// 08

Allgemeinchirurgische Instrumente
General surgery instruments · Instruments pour la chirurgie générale
Instrumentos para la cirugía general · Strumenti per chirurgia generale

// 09

Orthopädische Instrumente
Orthopaedic Instruments · Instruments pour l'orthopédie
Instrumentos para ortopedia · Strumenti per ortopedia

// 10

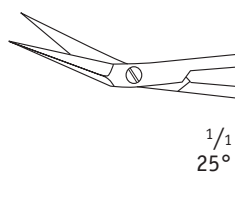
 Artikel-Nr.
 Cat. No.

 Gesamtlänge
 Total length

06-54-130

180 mm / 7"

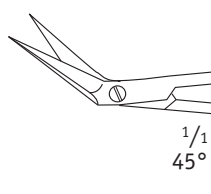

06-54-131

180 mm / 7"

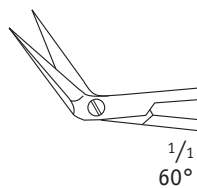

06-54-132

180 mm / 7"

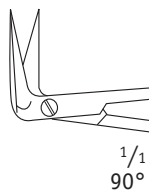

06-54-133

180 mm / 7"

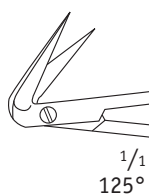

06-54-134

180 mm / 7"

Lieferbare Ausführungen · deliverable models · modèles disponibles · modelos disponibles · modelli disponibili

Standard Line

Oberfläche matt gebürstet

Surface polished · Surface brossée mate





Superficie cepillada mate · Superficie spazzolata

Bestellbeispiel

How to order · Exemple pour commander · Ejemplo para pedir · Esempio per comandare: 06-54-130

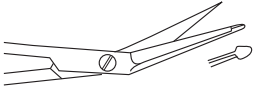
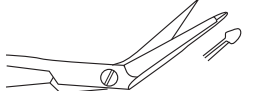
Black Line
 Oberfläche schwarz, titanbeschichtet · Surface black, titanium-coated · Surface noir, enduite de titane · Superficie negra, recubierto de titanio · Superficie nera, ricoperta di titanio
 Bestellbeispiel

How to order · Exemple pour commander · Ejemplo para pedir · Esempio per comandare: 06-54-130 B

Artikel-Nr. Cat. No.	Gesamtlänge Total length		
06-54-135	180 mm / 7"		$\frac{1}{1}$ 25°
06-54-136	180 mm / 7"		$\frac{1}{1}$ 45°
06-54-137	180 mm / 7"		$\frac{1}{1}$ 60°
06-54-138	180 mm / 7"		$\frac{1}{1}$ 90°
06-54-139	180 mm / 7"		$\frac{1}{1}$ 125°



1/1

Lieferbare Ausführungen · deliverable models · modèles disponibles · modelos disponibles · modelli disponibili

Standard Line

Oberfläche matt gebürstet
 Surface polished · Surface brossée mate ·
 Superficie cepillada mate · Superficie spazzolata

Bestellbeispiel
 How to order · Exemple pour commander · Ejemplo
 para pedir · Esempio per comandare: 06-54-135

Black Line

Oberfläche schwarz, titanbeschichtet · Surface black, titani-
 um-coated · Surface noir, enduite de titane · Superficie negra,
 recubierto de titanio · Superficie nera, ricoperta di titanio

Bestellbeispiel
 How to order · Exemple pour commander · Ejemplo
 para pedir · Esempio per comandare: 06-54-135 B

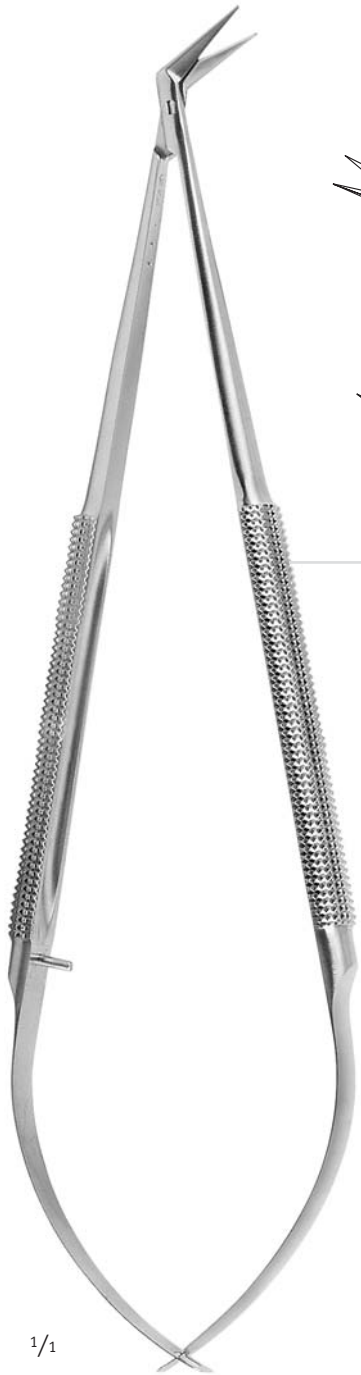

1/1

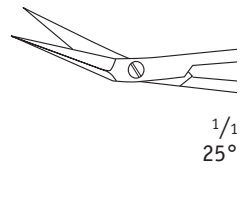
 Artikel-Nr.
 Cat. No.

 Gesamtlänge
 Total length

06-54-120

180 mm / 7"

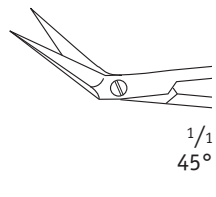

06-54-121

180 mm / 7"

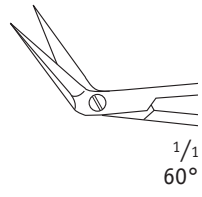

06-54-122

180 mm / 7"

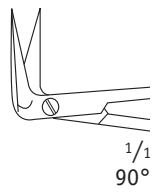

06-54-123

180 mm / 7"

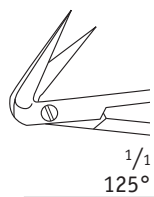

06-54-124

180 mm / 7"

Lieferbare Ausführungen · deliverable models · modèles disponibles · modelos disponibles · modelli disponibili

Standard Line
 Oberfläche matt gebürstet
 Surface polished · Surface brossée mate
 Superficie cepillada mate · Superficie spazzolata
 Bestellbeispiel

How to order · Exemple pour commander · Ejemplo para pedir · Esempio per comandare: 06-54-120

Black Line
 Oberfläche schwarz, titanbeschichtet · Surface black, titanium-coated · Surface noir, enduite de titane · Superficie negra, recubierto de titanio · Superficie nera, ricoperta di titanio
 Bestellbeispiel

How to order · Exemple pour commander · Ejemplo para pedir · Esempio per comandare: 06-54-120 B

Artikel-Nr.
 Cat. No.

Gesamtlänge
 Total length

06-54-125	180 mm / 7"
06-54-126	180 mm / 7"
06-54-127	180 mm / 7"
06-54-128	180 mm / 7"
06-54-129	180 mm / 7"

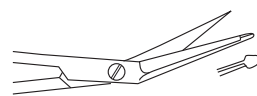

1/1
 25°



1/1
 45°

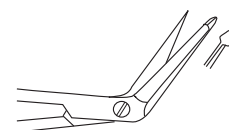

1/1
 60°



1/1
 90°



1/1
 125°

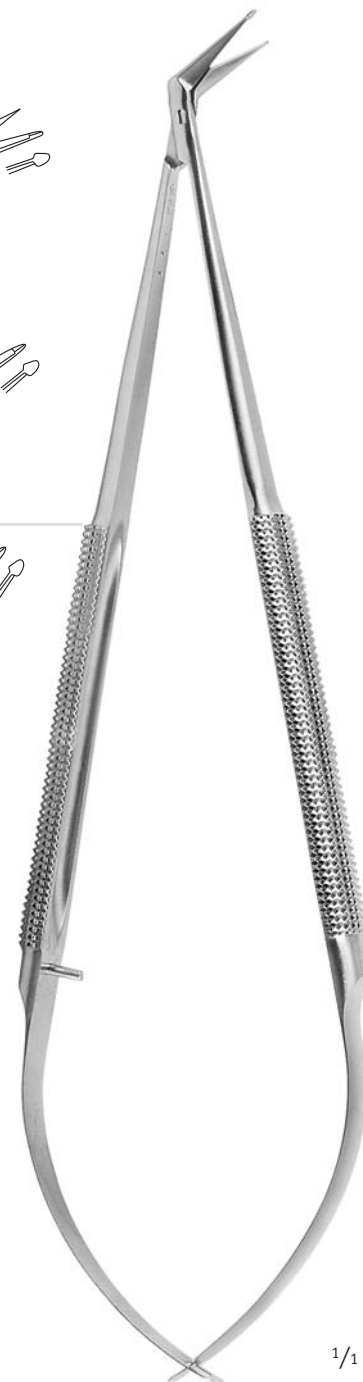

1/1



8

Lieferbare Ausführungen · deliverable models · modèles disponibles · modelos disponibles · modelli disponibili

Standard Line

Oberfläche matt gebürstet
 Surface polished · Surface brossée mate ·
 Superficie cepillada mate · Superficie spazzolata

Bestellbeispiel

How to order · Exemple pour commander · Ejemplo
 para pedir · Esempio per comandare: 06-54-125

Black Line







Oberfläche schwarz, titanbeschichtet · Surface black, titani-
 um-coated · Surface noir, enduite de titane · Superficie negra,
 recubierto de titanio · Superficie nera, ricoperta di titanio

Bestellbeispiel

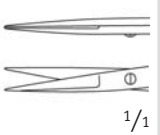
How to order · Exemple pour commander · Ejemplo
 para pedir · Esempio per comandare: 06-54-125 B

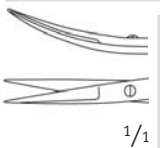

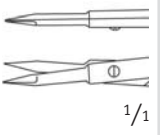
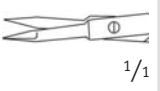
1/1

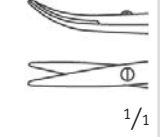
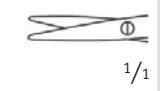
	Artikel-Nr. Cat. No.	Gesamtlänge Total length
	06-04-100	145 mm / 5 ³ / ₄ "
	06-04-600	180 mm / 7"
	06-04-101	145 mm / 5 ³ / ₄ "
	06-04-601	180 mm / 7"
	VANNAS	06-54-115 145 mm / 5 ³ / ₄ "
		06-54-116 180 mm / 7"
		06-04-117 230 mm / 9"
	06-04-103	145 mm / 5 ³ / ₄ "
	06-04-603	180 mm / 7"
		Präparierschere Dissecting Scissors · Ciseaux à dissection Tijeras de disección · Forbici per dissezione

Präparierschere
 Dissecting Scissors · Ciseaux à dissection
 Tijeras de disección · Forbici per dissezione

Lieferbare Ausführungen · deliverable models · modèles disponibles · modelos disponibles · modelli disponibili

Standard Line









Oberfläche matt gebürstet
 Surface polished · Surface brossée mate ·
 Superficie cepillada mate · Superficie spazzolata
 Bestellbeispiel

How to order · Exemple pour commander · Ejemplo
 para pedir · Esempio per comandare: 06-04-100

Black Line

Oberfläche schwarz, titanbeschichtet · Surface black, titani-
 um-coated · Surface noir, enduite de titane · Superficie negra,
 recubierto de titanio · Superficie nera, ricoperta di titanio
 Bestellbeispiel





















How to order · Exemple pour commander · Ejemplo
 para pedir · Esempio per comandare: 06-04-100 B

Artikel-Nr. Cat. No.	Gesamtlänge Total length		
06-04-100T	145 mm / 5 ³ / ₄ "		  1/1
06-04-600T	180 mm / 7"		
06-04-101T	145 mm / 5 ³ / ₄ "		  1/1
06-04-601T	180 mm / 7"		
06-54-115T	145 mm / 5 ³ / ₄ "	VANNAS	  1/1
06-54-116T	180 mm / 7"		
06-04-103T	145 mm / 5 ³ / ₄ "		  1/1
06-04-603T	180 mm / 7"	Präparierschere Dissecting Scissors · Ciseaux à dissection Tijeras de disección · Forbici per dissezione	



1/1



		Artikel-Nr. Cat. No.	Gesamtlänge Total length
	YASARGIL	06-04-012	120 mm / 4 ³ / ₄ "
	YASARGIL	06-04-016	160 mm / 6 ¹ / ₄ "
 1/1	MILLESI	06-04-020	160 mm / 6 ¹ / ₄ " gezahnt · toothed · dentelés · dentadas · dentata
	YASARGIL	06-04-022	185 mm / 7 ¹ / ₄ "
	YASARGIL	06-04-013	120 mm / 4 ³ / ₄ "
	YASARGIL	06-04-017	160 mm / 6 ¹ / ₄ "
 1/1	MILLESI	06-04-021	160 mm / 6 ¹ / ₄ " gezahnt · toothed · dentelés · dentadas · dentata
	JACOBSON	06-04-023	185 mm / 7 ¹ / ₄ "
	VANNAS	06-04-014	120 mm / 4 ³ / ₄ "
	VANNAS	06-04-018	160 mm / 6 ¹ / ₄ "
 1/1			
	VANNAS	06-04-015	120 mm / 4 ³ / ₄ "
	VANNAS	06-04-019	160 mm / 6 ¹ / ₄ "
 1/1			
		06-04-025	185 mm / 7 ¹ / ₄ " Präparierschere Dissecting Scissors · Ciseaux à dissection Tijeras de disección · Forbici per dissezione
			
 1/1	BIEMER	06-04-028	130 mm / 5 ¹ / ₈ " Venenschere Vein Scissors · Ciseaux pour veines · Tijera para venas · Forbici per vene
			
	VANNAS	06-04-011	120 mm / 4 ³ / ₄ " seitwärts gebogen · curved to side · courbe vers le côté · curva hacia un lado · curva lateralmente
 1/1			
	POTTS- YASARGIL	06-04-024	185 mm / 7 ¹ / ₄ " seitwärts gebogen · curved to side · courbe vers le côté · curva hacia un lado · curva lateralmente
 1/1 45°			

Lieferbare Ausführungen · deliverable models · modèles disponibles · modelos disponibles · modelli disponibili

Standard Line

 Oberfläche matt gebürstet
 Surface polished · Surface brossée mate ·
 Superficie cepillada mate · Superficie spazzolata
 Bestellbeispiel

 How to order · Exemple pour commander · Ejemplo
 para pedir · Esempio per comandare: 06-04-012

Black Line

 Oberfläche schwarz, titanbeschichtet · Surface black, titani-
 um-coated · Surface noir, enduite de titane · Superficie negra,
 recubierto de titanio · Superficie nera, ricoperta di titanio
 Bestellbeispiel

 How to order · Exemple pour commander · Ejemplo
 para pedir · Esempio per comandare: 06-04-012 B

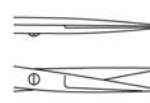
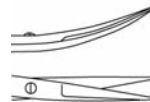
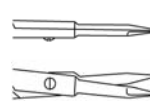
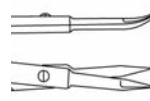
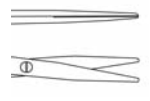
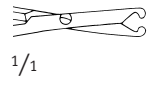
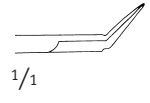
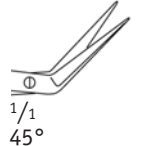
Artikel-Nr. Cat. No.	Gesamtlänge Total length		
06-54-012	120 mm / 4 ³ / ₄ "	MILLESI	 1/1
06-54-016	160 mm / 6 ¹ / ₄ "		
06-54-020	160 mm / 6 ¹ / ₄ " gezahnt · toothed · dentelés · dentadas · dentata		
06-54-022	185 mm / 7 ¹ / ₄ "		
06-54-013	120 mm / 4 ³ / ₄ "	MILLESI	 1/1
06-54-017	160 mm / 6 ¹ / ₄ "		
06-54-021	160 mm / 6 ¹ / ₄ " gezahnt · toothed · dentelés · dentadas · dentata		
06-54-023	185 mm / 7 ¹ / ₄ "		
06-54-014	120 mm / 4 ³ / ₄ "	VANNAS	 1/1
06-54-018	160 mm / 6 ¹ / ₄ "		
06-54-015	120 mm / 4 ³ / ₄ "	VANNAS	 1/1
06-54-019	160 mm / 6 ¹ / ₄ "		
06-54-025	185 mm / 7 ¹ / ₄ " Präparierschere Dissecting Scissors · Ciseaux à dissection Tijeras de disección · Forbici per dissezione		 1/1
06-54-028	130 mm / 5 ¹ / ₈ " Venenschere Vein Scissors · Ciseaux pour veines · Tijera para venas · Forbici per vene	BIEMER	 1/1
06-54-011	120 mm / 4 ³ / ₄ " seitwärts gebogen · curved to side · courbe vers le côté · curva hacia un lado · curva lateralmente	VANNAS	 1/1
06-54-024	185 mm / 7 ¹ / ₄ " seitwärts gebogen · curved to side · courbe vers le côté · curva hacia un lado · curva lateralmente	POTTS- YASARGIL	 1/1 45°



1/1

Lieferbare Ausführungen · deliverable models · modèles disponibles · modelos disponibles · modelli disponibili

Standard Line

Oberfläche matt gebürstet
 Surface polished · Surface brossée mate ·
 Superficie cepillada mate · Superficie spazzolata
 Bestellbeispiel
 How to order · Exemple pour commander · Ejemplo
 para pedir · Esempio per comandare: 06-54-012

Black Line

Oberfläche schwarz, titanbeschichtet · Surface black, titani-
 um-coated · Surface noir, enduite de titane · Superficie negra,
 recubierto de titanio · Superficie nera, ricoperta di titanio
 Bestellbeispiel
 How to order · Exemple pour commander · Ejemplo
 para pedir · Esempio per comandare: 06-54-012 B

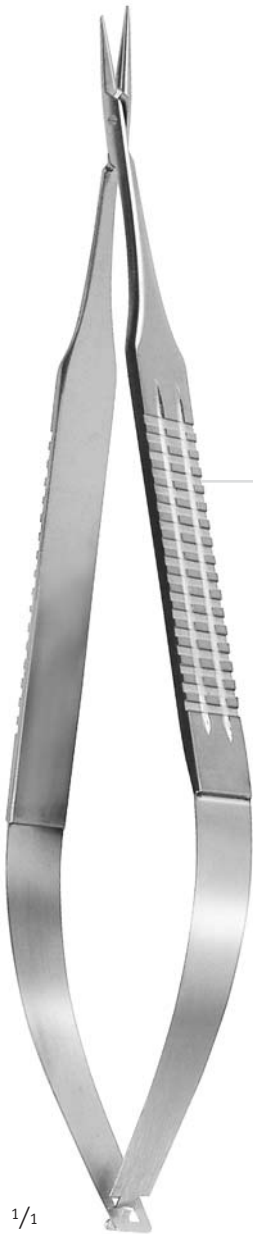
 Artikel-Nr.
 Cat. No.

 Gesamtlänge
 Total length

06-04-076

160 mm / 6¹/₄"

06-04-080

185 mm / 7¹/₄"
 ohne Sperre
 without catch · sans fermeture
 sin cerradura · senza serratura

06-04-079

160 mm / 6¹/₄"

06-04-081

185 mm / 7¹/₄"
 ohne Sperre
 without catch · sans fermeture
 sin cerradura · senza serratura

1/1

8



Lieferbare Ausführungen · deliverable models · modèles disponibles · modelos disponibles · modelli disponibili

Standard Line
 Oberfläche matt gebürstet
 Surface polished · Surface brossée mate ·
 Superficie cepillada mate · Superficie spazzolata
 Bestellbeispiel

 How to order · Exemple pour commander · Ejemplo
 para pedir · Esempio per comandare: 06-04-076
Black Line
 Oberfläche schwarz, titanbeschichtet · Surface black, titani-
 um-coated · Surface noir, enduite de titane · Superficie negra,
 recubierto de titanio · Superficie nera, ricoperta di titanio
 Bestellbeispiel

 How to order · Exemple pour commander · Ejemplo
 para pedir · Esempio per comandare: 06-04-076 B
Diamond Line

 Maul diamantbeschichtet
 Mouth diamond dust coated · Bouche diamantée ·
 Boca diamantada · Bocca diamantata
 Bestellbeispiel

 How to order · Exemple pour commander · Ejemplo
 para pedir · Esempio per comandare: 06-04-076 D

Artikel-Nr. Cat. No.	Gesamtlänge Total length		
06-54-076	160 mm / 6 ¹ / ₄ "		 1/1
06-54-080	185 mm / 7 ¹ / ₄ "		
	ohne Sperre without catch · sans fermeture sin cerradura · senza serratura		
06-54-079	160 mm / 6 ¹ / ₄ "		 1/1
06-54-081	185 mm / 7 ¹ / ₄ "		
	ohne Sperre without catch · sans fermeture sin cerradura · senza serratura		



Lieferbare Ausführungen · deliverable models · modèles disponibles · modelos disponibles · modelli disponibili

Standard Line

Oberfläche matt gebürstet
 Surface polished · Surface brossée mate ·
 Superficie cepillada mate · Superficie spazzolata

Bestellbeispiel
 How to order · Exemple pour commander · Ejemplo
 para pedir · Esempio per comandare: 06-54-076

Black Line

Oberfläche schwarz, titanbeschichtet · Surface black, tita-
 um-coated · Surface noir, enduite de titane · Superficie negra,
 recubierto de titanio · Superficie nera, ricoperta di titanio

Bestellbeispiel
 How to order · Exemple pour commander · Ejemplo
 para pedir · Esempio per comandare: 06-54-076 B

Diamond Line



Maul diamantbeschichtet
 Mouth diamond dust coated · Bouche diamantée ·
 Boca diamantada · Bocca diamantata

Bestellbeispiel
 How to order · Exemple pour commander · Ejemplo
 para pedir · Esempio per comandare: 06-54-076 D





1/1

		Artikel-Nr. Cat. No.	Gesamtlänge Total length
 1/1	BARRAQUER	06-04-230	120 mm / 4 ³ / ₄ "
	REILL	06-04-240	150 mm / 6"
		06-04-244	180 mm / 7"
		06-54-248	210 mm / 8 ¹ / ₄ "
		06-54-252	230 mm / 9"
ohne Sperre without catch · sans fermeture sin cerradura · senza serratura			
 1/1	BARRAQUER	06-04-231	120 mm / 4 ³ / ₄ "
			ohne Sperre without catch · sans fermeture sin cerradura · senza serratura
 1/1	REILL	06-04-241	150 mm / 6"
		06-04-245	180 mm / 7"
		06-54-251	210 mm / 8 ¹ / ₄ "
		06-54-255	230 mm / 9"
ohne Sperre without catch · sans fermeture sin cerradura · senza serratura			

Lieferbare Ausführungen · deliverable models · modèles disponibles · modelos disponibles · modelli disponibili

Standard Line
 Oberfläche matt gebürstet
 Surface polished · Surface brossée mate ·
 Superficie cepillada mate · Superficie spazzolata
 Bestellbeispiel

 How to order · Exemple pour commander · Ejemplo
 para pedir · Esempio per comandare: 06-04-230
Black Line
 Oberfläche schwarz, titanbeschichtet · Surface black, tita-
 num-coated · Surface noir, enduite de titane · Superficie negra,
 recubierto de titanio · Superficie nera, ricoperta di titanio
 Bestellbeispiel

 How to order · Exemple pour commander · Ejemplo
 para pedir · Esempio per comandare: 06-04-230 B
Diamond Line

 Maul diamantbeschichtet
 Mouth diamond dust coated · Bouche diamantée ·
 Boca diamantada · Bocca diamantata
 Bestellbeispiel

 How to order · Exemple pour commander · Ejemplo
 para pedir · Esempio per comandare: 06-04-230 D

Artikel-Nr. Cat. No.	Gesamtlänge Total length
06-04-240T	150 mm / 6"
06-04-244T	180 mm / 7"
06-54-248T	210 mm / 8 ¹ / ₄ "
ohne Sperre without catch · sans fermeture sin cerradura · senza serratura	
06-04-241T	150 mm / 6"
06-04-245T	180 mm / 7"
06-54-251T	210 mm / 8 ¹ / ₄ "
ohne Sperre without catch · sans fermeture sin cerradura · senza serratura	

REILL



1/1

REILL



1/1



1/1

Diamond Line



Maul diamantbeschichtet

Mouth diamond dust coated · Bouche diamantée ·

Boca diamantada · Bocca diamantata

Bestellbeispiel

How to order · Exemple pour commander · Ejemplo para pedir · Esempio per comandare: **06-04-240T D**

**BARRAQUER**
 Artikel-Nr.
 Cat. No.

 Gesamtlänge
 Total length

06-04-232

120 mm / 4³/₄"

06-04-242

150 mm / 6"

06-04-246

180 mm / 7"

06-54-250

210 mm / 8¹/₄"

06-54-254

230 mm / 9"

 mit Sperre
 with catch · avec fermeture
 con cerradura · con serratura
**BARRAQUER**

06-04-233

120 mm / 4³/₄"
 mit Sperre
 with catch · avec fermeture
 con cerradura · con serratura
**REILL**

06-04-243

150 mm / 6"

06-04-247

180 mm / 7"

06-54-253

210 mm / 8¹/₄"

06-04-249

230 mm / 9"

 mit Sperre
 with catch · avec fermeture
 con cerradura · con serratura

1/1

8

Lieferbare Ausführungen · deliverable models · modèles disponibles · modelos disponibles · modelli disponibili

Standard Line
 Oberfläche matt gebürstet
 Surface polished · Surface brossée mate ·
 Superficie cepillada mate · Superficie spazzolata
 Bestellbeispiel

 How to order · Exemple pour commander · Ejemplo
 para pedir · Esempio per comandare: 06-04-232
Black Line
 Oberfläche schwarz, titanbeschichtet · Surface black, titani-
 um-coated · Surface noir, enduite de titane · Superficie negra,
 recubierto de titanio · Superficie nera, ricoperta di titanio
 Bestellbeispiel

 How to order · Exemple pour commander · Ejemplo
 para pedir · Esempio per comandare: 06-04-232 B
Diamond Line
 Maul diamantbeschichtet
 Mouth diamond dust coated · Bouche diamantée ·
 Boca diamantada · Bocca diamantata
 Bestellbeispiel

 How to order · Exemple pour commander · Ejemplo
 para pedir · Esempio per comandare: 06-04-232 D

Artikel-Nr. Cat. No.	Gesamtlänge Total length
06-04-242T	150 mm / 6"
06-04-246T	180 mm / 7"
06-54-250T	210 mm / 8 ¹ / ₄ "
mit Sperre with catch · avec fermeture con cerradura · con serratura	
06-04-243T	150 mm / 6"
06-04-247T	180 mm / 7"
06-54-253T	210 mm / 8 ¹ / ₄ "
mit Sperre with catch · avec fermeture con cerradura · con serratura	

REILL



¹/₁

REILL



¹/₁



¹/₁

Lieferbare Ausführungen · deliverable models · modèles disponibles · modelos disponibles · modelli disponibili

Diamond Line



Maul diamantbeschichtet

Mouth diamond dust coated · Bouche diamantée ·

Boca diamantada · Bocca diamantata

Bestellbeispiel

How to order · Exemple pour commander · Ejemplo

para pedir · Esempio per comandare: 06-04-242T D





1/1
0,3 mm



1/1
0,3 mm

 Artikel-Nr.
 Cat. No.

 Gesamtlänge
 Total length

06-54-260

150 mm / 6"

06-54-262

180 mm / 7"

06-54-264

210 mm / 8¹/₄"

06-54-266

230 mm / 9"

 ohne Sperre
 without catch · sans fermeture
 sin cerradura · senza serratura

06-54-261

150 mm / 6"

06-54-263

180 mm / 7"

06-54-265

210 mm / 8¹/₄"

06-54-267

230 mm / 9"

 ohne Sperre
 without catch · sans fermeture
 sin cerradura · senza serratura

TC

1/1

Artikel-Nr. Cat. No.	Gesamtlänge Total length
06-54-270	150 mm / 6"
06-54-272	180 mm / 7"
06-54-274	210 mm / 8 ¹ / ₄ "
06-54-276	230 mm / 9"
mit Sperre with catch · avec fermeture con cerradura · con serratura	
06-54-271	150 mm / 6"
06-54-273	180 mm / 7"
06-54-275	210 mm / 8 ¹ / ₄ "
06-54-277	230 mm / 9"
mit Sperre with catch · avec fermeture con cerradura · con serratura	



1/1
0,3 mm



1/1
0,3 mm

TC



1/1

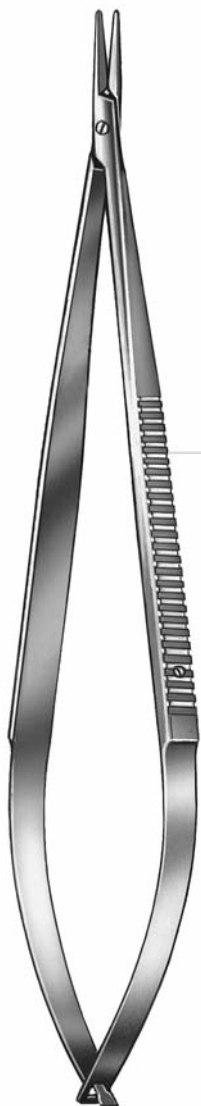

1/1

CASTROVIEJO**JACOBSON**
 Artikel-Nr.
 Cat. No.

 Gesamtlänge
 Total length

06-54-200

145 mm / 5³/₄"

06-04-045

180 mm / 7"

06-54-202

210 mm / 8¹/₄"

06-54-204

230 mm / 9"

 ohne Sperre
 without catch · sans fermeture
 sin cerradura · senza serratura

1/1

CASTROVIEJO**JACOBSON**

06-54-201

145 mm / 5³/₄"

06-54-045

180 mm / 7"

06-54-203

210 mm / 8¹/₄"

06-54-205

230 mm / 9"

 ohne Sperre
 without catch · sans fermeture
 sin cerradura · senza serratura



Lieferbare Ausführungen · deliverable models · modèles disponibles · modelos disponibles · modelli disponibili

Standard Line
 Oberfläche matt gebürstet
 Surface polished · Surface brossée mate ·
 Superficie cepillada mate · Superficie spazzolata
 Bestellbeispiel

 How to order · Exemple pour commander · Ejemplo
 para pedir · Esempio per comandare: 06-54-200
Black Line
 Oberfläche schwarz, titanbeschichtet · Surface black, tita-
 num-coated · Surface noir, enduite de titane · Superficie negra,
 recubierto de titanio · Superficie nera, ricoperta di titanio
 Bestellbeispiel

 How to order · Exemple pour commander · Ejemplo
 para pedir · Esempio per comandare: 06-54-200 B
Diamond Line
 Maul diamantbeschichtet
 Mouth diamond dust coated · Bouche diamantée ·
 Boca diamantada · Bocca diamantata
 Bestellbeispiel

 How to order · Exemple pour commander · Ejemplo
 para pedir · Esempio per comandare: 06-54-200 D

Artikel-Nr. Cat. No.	Gesamtlänge Total length		
02-13-563	145 mm / 5 ³ / ₄ "	CASTROVIEJO JACOBSON	 1/1
06-04-046	180 mm / 7"		
06-54-206	210 mm / 8 ¹ / ₄ "		
06-54-208	230 mm / 9"		
mit Sperre with catch · avec fermeture con cerradura · con serratura			
02-13-564	145 mm / 5 ³ / ₄ "	CASTROVIEJO JACOBSON	 1/1
06-54-046	180 mm / 7"		
06-54-207	210 mm / 8 ¹ / ₄ "		
06-54-209	230 mm / 9"		
mit Sperre with catch · avec fermeture con cerradura · con serratura			

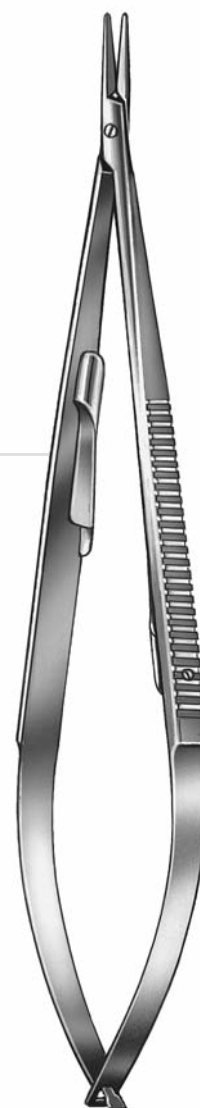

1/1



8

Lieferbare Ausführungen · deliverable models · modèles disponibles · modelos disponibles · modelli disponibili

Standard Line

Oberfläche matt gebürstet
 Surface polished · Surface brossée mate ·
 Superficie cepillada mate · Superficie spazzolata

Bestellbeispiel
 How to order · Exemple pour commander · Ejemplo
 para pedir · Esempio per comandare: 02-13-563

Black Line

Oberfläche schwarz, titanbeschichtet · Surface black, tita-
 num-coated · Surface noir, enduite de titane · Superficie negra,
 recubierto de titanio · Superficie nera, ricoperta di titanio

Bestellbeispiel
 How to order · Exemple pour commander · Ejemplo
 para pedir · Esempio per comandare: 02-13-563 B





Diamond Line

Maul diamantbeschichtet
 Mouth diamond dust coated · Bouche diamantée ·
 Boca diamantada · Bocca diamantata





Bestellbeispiel
 How to order · Exemple pour commander · Ejemplo
 para pedir · Esempio per comandare: 02-13-563 D





	Artikel-Nr. Cat. No.	Gesamtlänge Total length
 $\frac{1}{1}$	CASTROVIEJO JACOBSON	
	06-54-210	145 mm / 5 ³ / ₄ "
	06-54-212	180 mm / 7"
	06-54-214	210 mm / 8 ¹ / ₄ "
	06-54-216	230 mm / 9"
ohne Sperre without catch · sans fermeture sin cerradura · senza serratura		
 $\frac{1}{1}$	CASTROVIEJO JACOBSON	
	06-54-211	145 mm / 5 ³ / ₄ "
	06-54-213	180 mm / 7"
	06-54-215	210 mm / 8 ¹ / ₄ "
	06-54-217	230 mm / 9"
ohne Sperre without catch · sans fermeture sin cerradura · senza serratura		
 $\frac{1}{1}$ 0,3 mm	CASTROVIEJO JACOBSON	
	06-54-218	145 mm / 5 ³ / ₄ "
	06-54-117	180 mm / 7"
	06-54-220	210 mm / 8 ¹ / ₄ "
	06-54-222	230 mm / 9"
ohne Sperre without catch · sans fermeture sin cerradura · senza serratura		
 $\frac{1}{1}$ 0,3 mm	CASTROVIEJO JACOBSON	
	06-54-219	145 mm / 5 ³ / ₄ "
	06-54-118	180 mm / 7"
	06-54-221	210 mm / 8 ¹ / ₄ "
	06-54-223	230 mm / 9"
ohne Sperre without catch · sans fermeture sin cerradura · senza serratura		

TC

Artikel-Nr. Cat. No.	Gesamtlänge Total length		
02-13-001	145 mm / 5 ³ / ₄ "	CASTROVIEJO JACOBSON	 1/1
06-54-224	180 mm / 7"		
06-54-226	210 mm / 8 ¹ / ₄ "		
06-54-228	230 mm / 9"		
mit Sperre with catch · avec fermeture con cerradura · con serratura			
02-63-001	145 mm / 5 ³ / ₄ "	CASTROVIEJO JACOBSON	 1/1
06-54-225	180 mm / 7"		
06-54-227	210 mm / 8 ¹ / ₄ "		
06-54-229	230 mm / 9"		
mit Sperre with catch · avec fermeture con cerradura · con serratura			
02-13-002	145 mm / 5 ³ / ₄ "	CASTROVIEJO JACOBSON	 1/1 0,3 mm
02-13-004	180 mm / 7"		
02-13-005	210 mm / 8 ¹ / ₄ "		
02-63-230	230 mm / 9"		
mit Sperre with catch · avec fermeture con cerradura · con serratura			
02-63-002	145 mm / 5 ³ / ₄ "	CASTROVIEJO JACOBSON	 1/1 0,3 mm
02-63-004	180 mm / 7"		
02-63-005	210 mm / 8 ¹ / ₄ "		
02-63-231	230 mm / 9"		
mit Sperre with catch · avec fermeture con cerradura · con serratura			



1/1







8

TC



1/1

	Artikel-Nr. Cat. No.	Gesamtlänge Total length
 $\frac{1}{1}$ $\varnothing 1 \text{ mm}$	06-54-937	150 mm / 6"
	06-54-938	180 mm / 7"
	06-54-939	210 mm / 8 $\frac{1}{4}$ "
Ringe gerieft <i>Rings serrated · Anneaux striés</i> <i>Anillos estriados · Anelli striati</i>		
 $\frac{1}{1}$ $\varnothing 1 \text{ mm}$	06-54-940	150 mm / 6"
	06-54-941	180 mm / 7"
	06-54-942	210 mm / 8 $\frac{1}{4}$ "
Ringe diamantbeschichtet <i>Rings diamond dust coated · Anneaux à couche diamantée</i> <i>Anillos diamantados · Anelli diamantati</i>		
 $\frac{1}{1}$ $\varnothing 2 \text{ mm}$	06-54-943	150 mm / 6"
	06-54-944	180 mm / 7"
	06-54-945	210 mm / 8 $\frac{1}{4}$ "
Ringe gerieft <i>Rings serrated · Anneaux striés</i> <i>Anillos estriados · Anelli striati</i>		
 $\frac{1}{1}$ $\varnothing 2 \text{ mm}$	06-54-946	150 mm / 6"
	06-54-947	180 mm / 7"
	06-54-948	210 mm / 8 $\frac{1}{4}$ "
Ringe diamantbeschichtet <i>Rings diamond dust coated · Anneaux à couche diamantée</i> <i>Anillos diamantados · Anelli diamantati</i>		

Lieferbare Ausführungen · deliverable models · modèles disponibles · modelos disponibles · modelli disponibili

Standard Line

Oberfläche matt gebürstet

Surface polished · Surface brossée mate
Superficie cepillada mate · Superficie spazzolata

Bestellbeispiel

How to order · Exemple pour commander · Ejemplo para pedir · Esempio per comandare: 06-54-937
Black Line

 Oberfläche schwarz, titanbeschichtet · *Surface black, titanium-coated · Surface noir, enduite de titane · Superficie negra, recubierto de titanio · Superficie nera, ricoperta di titanio*
 Bestellbeispiel

How to order · Exemple pour commander · Ejemplo para pedir · Esempio per comandare: 06-54-937 B

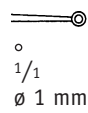
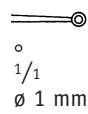
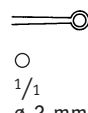
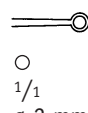
Artikel-Nr. Cat. No.	Gesamtlänge Total length	
06-54-937T	150 mm / 6"	 ∅ 1 mm
06-54-938T	180 mm / 7"	
06-54-939T	210 mm / 8 ¹ / ₄ "	
	Ringe gerieft Rings serrated · Anneaux striés Anillos estriados · Anelli striati	
06-54-940T	150 mm / 6"	 ∅ 1 mm
06-54-941T	180 mm / 7"	
06-54-942T	210 mm / 8 ¹ / ₄ "	
	Ringe diamantbeschichtet Rings diamond dust coated · Anneaux à couche diamantée Anillos diamantados · Anelli diamantati	
06-54-943T	150 mm / 6"	 ∅ 2 mm
06-54-944T	180 mm / 7"	
06-54-945T	210 mm / 8 ¹ / ₄ "	
	Ringe gerieft Rings serrated · Anneaux striés Anillos estriados · Anelli striati	
06-54-946T	150 mm / 6"	 ∅ 2 mm
06-54-947T	180 mm / 7"	
06-54-948T	210 mm / 8 ¹ / ₄ "	
	Ringe diamantbeschichtet Rings diamond dust coated · Anneaux à couche diamantée Anillos diamantados · Anelli diamantati	

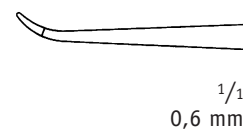
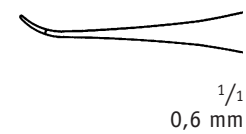
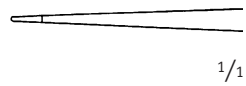
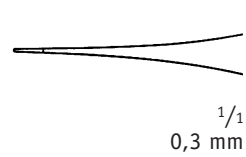

1/1

 Artikel-Nr.
 Cat. No.

 Gesamtlänge
 Total length

06-04-280

120 mm / 4³/₄"

06-04-284

150 mm / 6"

06-54-286

180 mm / 7"

06-54-288

210 mm / 8¹/₄"

06-54-280

120 mm / 4³/₄"

06-54-284

150 mm / 6"

06-04-286

180 mm / 7"

06-54-290

210 mm / 8¹/₄"

06-04-288

230 mm / 9"

06-04-281

120 mm / 4³/₄"

06-04-285

150 mm / 6"

06-54-287

180 mm / 7"

06-54-289

210 mm / 8¹/₄"

06-54-281

120 mm / 4³/₄"

06-54-285

150 mm / 6"

06-04-287

180 mm / 7"

06-54-291

210 mm / 8¹/₄"

06-54-293

230 mm / 9"

Lieferbare Ausführungen · deliverable models · modèles disponibles · modelos disponibles · modelli disponibili

Standard Line

Oberfläche matt gebürstet

Surface polished · Surface brossée mate

Superficie cepillada mate · Superficie spazzolata

Bestellbeispiel

How to order · Exemple pour commander · Ejemplo para pedir · Esempio per comandare: 06-04-280

Black Line

Oberfläche schwarz, titanbeschichtet · Surface black, titanium-coated · Surface noir, enduite de titane · Superficie negra, recubierto de titanio · Superficie nera, ricoperta di titanio

 Bestellbeispiel
 How to order · Exemple pour commander · Ejemplo para pedir · Esempio per comandare: 06-04-280 B

Diamond Line

Maul diamantbeschichtet

Mouth diamond dust coated · Bouche diamantée

Boca diamantada · Bocca diamantata

Bestellbeispiel

How to order · Exemple pour commander · Ejemplo para pedir · Esempio per comandare: 06-04-280 D



Artikel-Nr. Cat. No.	Gesamtlänge Total length
06-04-284T	150 mm / 6"
06-54-286T	180 mm / 7"
06-54-288T	210 mm / 8 ¹ / ₄ "
06-54-284T	150 mm / 6"
06-04-286T	180 mm / 7"
06-54-290T	210 mm / 8 ¹ / ₄ "
06-04-285T	150 mm / 6"
06-54-287T	180 mm / 7"
06-54-289T	210 mm / 8 ¹ / ₄ "
06-54-285T	150 mm / 6"
06-04-287T	180 mm / 7"
06-54-291T	210 mm / 8 ¹ / ₄ "

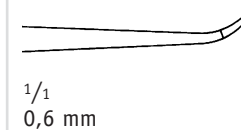
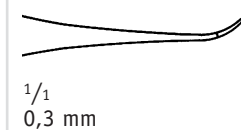
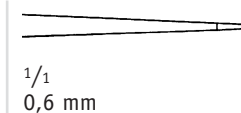
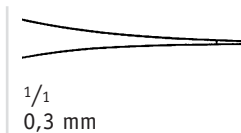

Lieferbare Ausführungen · deliverable models · modèles disponibles · modelos disponibles · modelli disponibili

Diamond Line

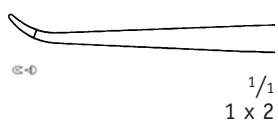
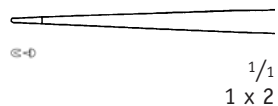
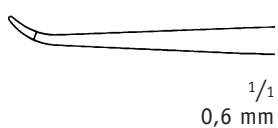
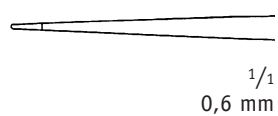

Maul diamantbeschichtet
 Mouth diamond dust coated · Bouche diamantée ·
 Boca diamantada · Bocca diamantata
 Bestellbeispiel
 How to order · Exemple pour commander · Ejemplo
 para pedir · Esempio per comandare: 06-04-284T D

 Artikel-Nr.
 Cat. No.

 Gesamtlänge
 Total length

06-54-950

150 mm / 6"

06-54-951

180 mm / 7"

06-54-952

210 mm / 8¹/₄"
 mit Gegengewicht
 with counter weight · avec contre-poids
 con contrapeso · con contrappeso

06-54-953

150 mm / 6"

06-54-954

180 mm / 7"

06-54-955

210 mm / 8¹/₄"
 mit Gegengewicht
 with counter weight · avec contre-poids
 con contrapeso · con contrappeso

06-54-960

150 mm / 6"

06-54-961

180 mm / 7"

06-54-962

210 mm / 8¹/₄"
 mit Gegengewicht
 with counter weight · avec contre-poids
 con contrapeso · con contrappeso

06-54-963

150 mm / 6"

06-54-964

180 mm / 7"

06-54-965

210 mm / 8¹/₄"
 mit Gegengewicht
 with counter weight · avec contre-poids
 con contrapeso · con contrappeso



Lieferbare Ausführungen · deliverable models · modèles disponibles · modelos disponibles · modelli disponibili

Standard Line
 Oberfläche matt gebürstet
 Surface polished · Surface brossée mate ·
 Superficie cepillada mate · Superficie spazzolata
 Bestellbeispiel

 How to order · Exemple pour commander · Ejemplo
 para pedir · Esempio per comandare: 06-54-950
Black Line
 Oberfläche schwarz, titanbeschichtet · Surface black, tita-
 num-coated · Surface noir, enduite de titane · Superficie negra,
 recubierto de titanio · Superficie nera, ricoperta di titanio
 Bestellbeispiel

 How to order · Exemple pour commander · Ejemplo
 para pedir · Esempio per comandare: 06-54-950 B
Diamond Line
 Maul diamantbeschichtet
 Mouth diamond dust coated · Bouche diamantée ·
 Boca diamantada · Bocca diamantata
 Bestellbeispiel

 How to order · Exemple pour commander · Ejemplo
 para pedir · Esempio per comandare: 06-54-950 D

Artikel-Nr. Cat. No.	Gesamtlänge Total length	
06-54-970	150 mm / 6"	 ◦ 1/1 Ø 1 mm
06-54-971	180 mm / 7"	
06-54-972	210 mm / 8 ¹ / ₄ "	
mit Gegengewicht with counter weight · avec contre-poids con contrapeso · con contrappeso		
06-54-973	150 mm / 6"	 ○ 1/1 Ø 2 mm
06-54-974	180 mm / 7"	
06-54-975	210 mm / 8 ¹ / ₄ "	
mit Gegengewicht with counter weight · avec contre-poids con contrapeso · con contrappeso		



1/1

Lieferbare Ausführungen · deliverable models · modèles disponibles · modelos disponibles · modelli disponibili

Standard Line

Oberfläche matt gebürstet
 Surface polished · Surface brossée mate ·
 Superficie cepillada mate · Superficie spazzolata
 Bestellbeispiel
 How to order · Exemple pour commander · Ejemplo
 para pedir · Esempio per comandare: 06-54-970

Black Line

Oberfläche schwarz, titanbeschichtet · Surface black, tita-
 um-coated · Surface noir, enduite de titane · Superficie negra,
 recubierto de titanio · Superficie nera, ricoperta di titanio
 Bestellbeispiel
 How to order · Exemple pour commander · Ejemplo
 para pedir · Esempio per comandare: 06-54-970 B

Diamond Line

Maul diamantbeschichtet
 Mouth diamond dust coated · Bouche diamantée ·
 Boca diamantada · Bocca diamantata
 Bestellbeispiel
 How to order · Exemple pour commander · Ejemplo
 para pedir · Esempio per comandare: 06-54-950 D

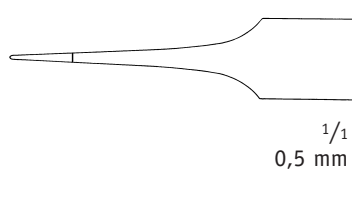

LAZAR

 Artikel-Nr.
 Cat. No.

 Gesamtlänge
 Total length

02-04-260

155 mm / 6"

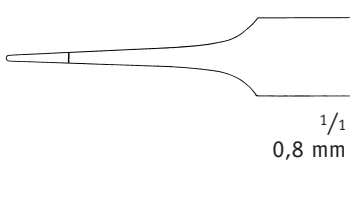

LAZAR

02-04-261

155 mm / 6"

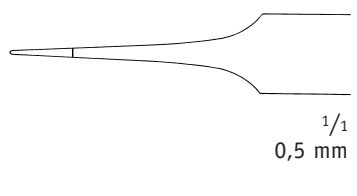

02-04-264

185 mm / 7¹/₄"

1/1

Lieferbare Ausführungen · deliverable models · modèles disponibles · modelos disponibles · modelli disponibili

Standard Line

Oberfläche matt gebürstet

Surface polished · Surface brossée mate ·

Superficie cepillada mate · Superficie spazzolata

Bestellbeispiel

 How to order · Exemple pour commander · Ejemplo
 para pedir · Esempio per comandare: 02-04-260
Diamond Line





Maul diamantbeschichtet

Mouth diamond dust coated · Bouche diamantée ·

Boca diamantada · Bocca diamantata

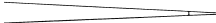
Bestellbeispiel

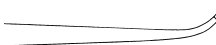
 How to order · Exemple pour commander · Ejemplo
 para pedir · Esempio per comandare: 02-04-260 D

Artikel-Nr. Cat. No.	Gesamtlänge Total length		
02-04-338	120 mm / 4 ³ / ₄ "		 1/1 0,3 mm
02-04-336	135 mm / 5 ¹ / ₄ "	WISE	 1/1 0,3 mm
02-04-337	135 mm / 5 ¹ / ₄ "	WISE	 1/1 0,3 mm
02-04-345	135 mm / 5 ¹ / ₄ "	WISE	 1/1 1 x 2



1/1

Lieferbare Ausführungen · deliverable models · modèles disponibles · modelos disponibles · modelli disponibili









Standard Line





Oberfläche matt gebürstet
 Surface polished · Surface brossée mate ·
 Superficie cepillada mate · Superficie spazzolata
 Bestellbeispiel
 How to order · Exemple pour commander · Ejemplo
 para pedir · Esempio per comandare: 02-04-338

Diamond Line

Maul diamantbeschichtet
 Mouth diamond dust coated · Bouche diamantée ·
 Boca diamantada · Bocca diamantata
 Bestellbeispiel
 How to order · Exemple pour commander · Ejemplo
 para pedir · Esempio per comandare: 02-04-338 D

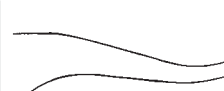

 1/1	 1/1	Artikel-Nr. Cat. No.	Gesamtlänge Total length 02-04-335 120 mm / 4 ³ / ₄ "
 1/1	 1/1	Artikel-Nr. Cat. No.	Gesamtlänge Total length 02-54-331 110 mm / 4 ¹ / ₄ " fein <i>delicate · délicate · fina · fina</i>
 1/1	 1/1	Artikel-Nr. Cat. No.	Gesamtlänge Total length 02-54-332 110 mm / 4 ¹ / ₄ "
 1/1	 1/1	Artikel-Nr. Cat. No.	Gesamtlänge Total length 02-54-333 110 mm / 4 ¹ / ₄ "

Artikel-Nr. Cat. No.	Gesamtlänge Total length	
02-04-331	110 mm / 4 ³ / ₈ "	 1/1 ø 0,15 mm
02-04-330	110 mm / 4 ³ / ₈ "	 1/1 ø 0,2 mm
02-04-329	110 mm / 4 ³ / ₈ "	 1/1 ø 0,3 mm
02-04-333	115 mm / 4 ¹ / ₂ "	 1/1 ø 0,2 mm
02-04-343	115 mm / 4 ¹ / ₂ "	 1/1



1/1



1/1



8



Bulldogklemmen, Gefäßclips
Bulldog Clamps, Vessel Clips · Clamps Bulldog, Clips vasculaires
Clamps Bulldog, Clips vasculares · Pinze Bulldog, Clips vascolari

// 01

Atraumatische Gefäßklemmen
Atraumatic Vascular Clamps · Pincés vasculaires atraumatiques
Pinzas vasculares atraumáticas · Pinze vascolari atraumatiche

// 02

Atraumatische Pinzetten
Atraumatic Tissue Forceps · Pincés atraumatiques
Pinzas atraumáticas · Pinze atraumatiche

// 03

Rippensperrer
Rib Spreaders · Ecarteurs pour costaux
Separadores costales · Divaricatori costali

// 04

Atrium, Aorta-Instrumente
Atrium-, Aortic Instruments · Instruments pour l'oreillette et l'aorte
Instrumentos para el atrium y la aorta · Strumenti per atrio e aorta

// 05

Wundhaken, Wundspreizer
Retractors · Ecarteurs
Separadores · Divaricatori

// 06

Sonden, Dilatationsinstrumente
Probes, Instruments for dilatation · Sondes, Instruments pour la dilatation
Sondas, Instrumentos para la dilatación · Sonda, Strumenti a dilatazione

// 07

Mikro-Instrumente
Micro Instruments · Micro instruments
Instrumentos para microcirugía · strumenti per microchirurgia

// 08

Allgemeinchirurgische Instrumente
General surgery instruments · Instruments pour la chirurgie générale
Instrumentos para la cirugía general · Strumenti per chirurgia generale

// 09

Orthopädische Instrumente
Orthopaedic Instruments · Instruments pour l'orthopédie
Instrumentos para ortopedia · Strumenti per ortopedia

// 10





Gr.
 3

Skalpellegriffe, passend für auswechselbare Skalpelleklingen Fig. 10, 11, 12, 13, 15

Scalpel Handles for scalpel blades fig. 10, 11, 12, 13, 15

Manches pour bistouris, allant avec les lames de bistouris interchangeables fig. 10, 11, 12, 13, 15

Mangos de bisturías para hojas intercambiables fig. 10, 11, 12, 13, 15

Manici per bisturi, per fissare le lame intercambiabili fig. 10, 11, 12, 13, 15



1/2

 Artikel-Nr.
 Cat. No.

 Gesamtlänge
 Total length

02-02-073

 125 mm / 4³/₄"
 No. 3

02-52-073

 125 mm / 5"
 No. 3

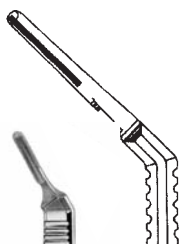
 mit Zentimeter-Graduierung
 cm-graduation · gradué en cm
 graduado en cm · graduato in cm

1/2

02-02-075

 210 mm / 8¹/₂"
 No. 3L

02-52-075

 210 mm / 8¹/₂"
 No. 3L

 abgewinkelt
 angled · coudé · angulado · angolato

1/2

Skalpellgriffe, passend für auswechselbare Skalpellklingen Fig. 10, 11, 12, 13, 15
 Scalpel Handles for scalpel blades fig. 10, 11, 12, 13, 15
 Manches pour bistouris, allant avec les lames de bistouris interchangeables fig. 10, 11, 12, 13, 15
 Mangos de bisturíes para hojas intercambiables fig. 10, 11, 12, 13, 15
 Manici per bisturi, per fissare le lame intercambiabili fig. 10, 11, 12, 13, 15

Gr.
3

Artikel-Nr. Cat. No.	Gesamtlänge Total length
02-02-063	145 mm / 5 ³ / ₄ " No. 3R rund <i>round · rond · redondo · rotondo</i>



02-52-063	140 mm / 5 ³ / ₄ " No. 3R rund, abgewinkelt <i>round, angled · rond, coudé</i> <i>redondo, angulado · rotondo, angolato</i>
------------------	---



02-52-060	Skalpellklingen-Entferner <i>Scalpel Blade Remover · Enlève-lames</i> <i>Quita hojas · Distributore lame</i>
------------------	--

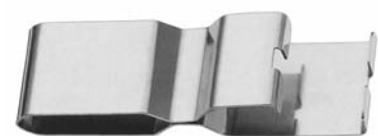

Gr.
 3

Skalpellgriffe, passend für auswechselbare Skalpellklingen Fig. 10, 11, 12, 13, 15

Scalpel Handles for scalpel blades fig. 10, 11, 12, 13, 15

Manches pour bistouris, allant avec les lames de bistouris interchangeables fig. 10, 11, 12, 13, 15

Mangos de bisturías para hojas intercambiables fig. 10, 11, 12, 13, 15

Manici per bisturi, per fissare le lame intercambiabili fig. 10, 11, 12, 13, 15

 $\frac{2}{3}$

 $\frac{2}{3}$
 $\frac{2}{3}$

5

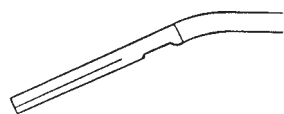
 Artikel-Nr.
 Cat. No.

 Gesamtlänge
 Total length

02-52-078

 160 mm / 6¹/₄"
 No. 5

02-02-078

 215 mm / 8¹/₂"
 No. 5

02-02-079

 210 mm / 8¹/₄"
 No. 5

 abgewinkelt
angled · coudé · angulado · angolato

Skalpellgriffe, passend für auswechselbare Skalpellklingen Fig. 10, 11, 12, 13, 15
 Scalpel Handles for scalpel blades fig. 10, 11, 12, 13, 15
 Manches pour bistouris, allant avec les lames de bistouris interchangeables fig. 10, 11, 12, 13, 15
 Mangos de bisturíes para hojas intercambiables fig. 10, 11, 12, 13, 15
 Manici per bisturi, per fissare le lame intercambiabili fig. 10, 11, 12, 13, 15

Gr.
3

Artikel-Nr. Cat. No.	Gesamtlänge Total length
02-02-077	160 mm / 6 ¹ / ₄ " No. 7



02-52-077	125 mm / 5" No. 7K
-----------	-----------------------



02-52-079	220 mm / 8 ³ / ₄ " No. 7L
-----------	--



Gr.
 4

Skalpellegriffe, passend für auswechselbare Skalpelleklingen Fig. 18, 19, 20, 21, 22, 23, 24, 25, 34, 36
 Scalpel Handles for scalpel blades fig. 18, 19, 20, 21, 22, 23, 24, 25, 34, 36
 Manches pour bistouris, allant avec les lames de bistouris interchangeables fig. 18, 19, 20, 21, 22, 23, 24, 25, 34, 36
 Mangos de bisturías para hojas intercambiables fig. 18, 19, 20, 21, 22, 23, 24, 25, 34, 36
 Manici per bisturi, per fissare le lame intercambiabili fig. 18, 19, 20, 21, 22, 23, 24, 25, 34, 36

 Artikel-Nr.
 Cat. No.

 Gesamtlänge
 Total length

02-02-084

 135 mm / 5¹/₄"
 No. 4

02-52-084

 135 mm / 5¹/₄"
 No. 4

 mit Zentimeter-Graduierung
 cm-graduation · gradué en cm
 graduado en cm · graduato in cm

02-02-085

 210 mm / 8¹/₄"
 No. 4L











02-52-085

 210 mm / 8¹/₄"
 No. 4L

 abgewinkelt
 angled · coudé · angulado · angolato

1/2

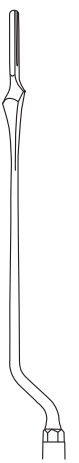
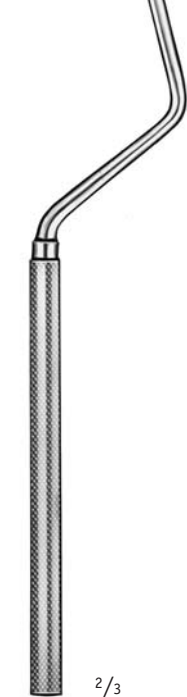

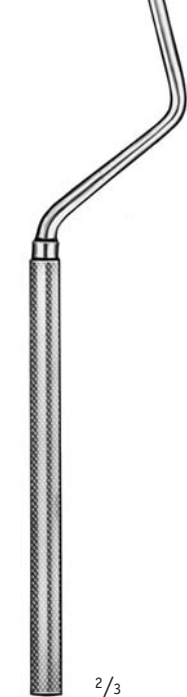
4L



Artikel-Nr. Cat. No.	Gesamtlänge Total length	LANDOLT	 1/2	 1/2	 2/3
02-02-053	210 mm / 8 ¹ / ₄ "	LANDOLT	 1/2	 1/2	 2/3
02-02-057	250 mm / 10"	für mikrochirurgische Klagen for microsurgery blades pour lames microchirurgicaux para hojas microquirúrgicas per lame microchirurgici		 1/2	 2/3
02-02-071	210 mm / 8 ¹ / ₄ " horizontal horizontal · horizontal · horizontal · orizzontale		 1/2	 1/2	 2/3
02-52-071	210 mm / 8 ¹ / ₄ " vertikal vertical · vertical · vertical · verticale			 1/2	 2/3





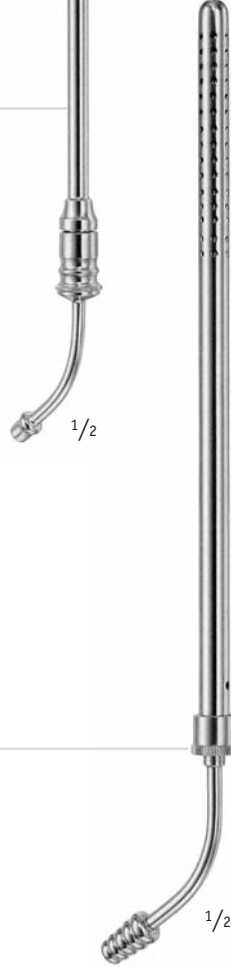



	Artikel-Nr. Cat. No.	Gesamtlänge Total length
 1/1	02-02-046	135 mm / 5 ¹ / ₄ " für mikrochirurgische Klengen <i>for microsurgery blades</i> <i>pour lames microchirurgicaux</i> <i>para hojas microquirúrgicas</i> <i>per lame microchirurgici</i>
 1/1	02-02-048	155 mm / 6" für mikrochirurgische Klengen <i>for microsurgery blades</i> <i>pour lames microchirurgicaux</i> <i>para hojas microquirúrgicas</i> <i>per lame microchirurgici</i>
 1/1	CASPAR 02-02-052	180 mm / 7" für mikrochirurgische Klengen <i>for microsurgery blades</i> <i>pour lames microchirurgicaux</i> <i>para hojas microquirúrgicas</i> <i>per lame microchirurgici</i>
 1/1	02-02-054	200 mm / 8" für mikrochirurgische Klengen <i>for microsurgery blades</i> <i>pour lames microchirurgicaux</i> <i>para hojas microquirúrgicas</i> <i>per lame microchirurgici</i>

1/1





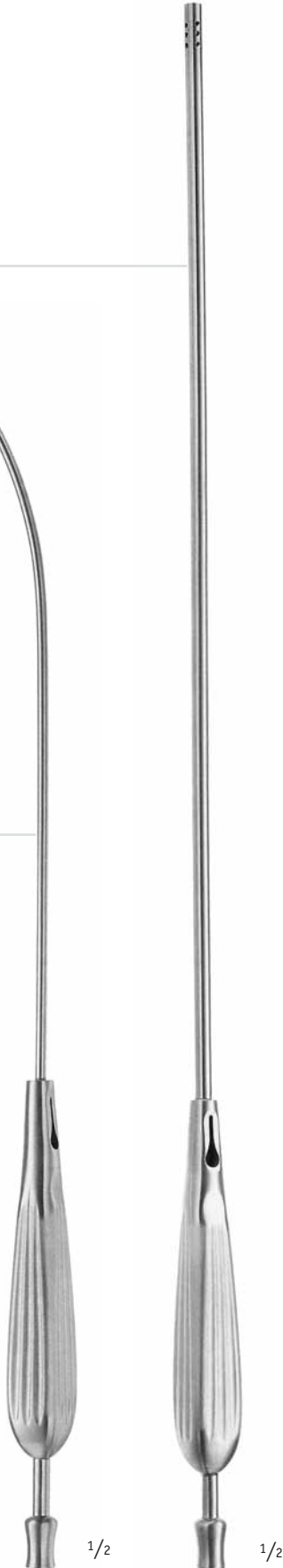

Artikel-Nr. Cat. No.	Gesamtlänge Total length		
07-06-862	230 mm / 8 ³ / ₄ " ø 10 mm, 30 Fr.	POOLE	
07-56-863	200 mm / 10" ø 5,5 mm, 16-17 Fr.	BABY- POOLE	 
07-06-860	230 mm / 8 ³ / ₄ " ø 8 mm, 23-24 Fr.	POOLE	

	Artikel-Nr. Cat. No.	Gesamtlänge Total length
 1/2	COOLEY 07-56-800	350 mm / 14" ø 8 mm
 1/2	COOLEY 07-56-801	310 mm / 12 ¹ / ₂ " ø 9 mm
 1/2	COOLEY 07-56-802	300 mm / 12" ø 8 mm



Artikel-Nr. Cat. No.	Gesamtlänge Total length		
07-56-805	450 mm / 17 ³ / ₄ " Nutzlänge 320 mm / 12 ¹ / ₂ " working length 320 mm / 12 ¹ / ₂ " longueur utile 320 mm / 12 ¹ / ₂ " largura útil 320 mm / 12 ¹ / ₂ " lunghezza utile 320 mm / 12 ¹ / ₂ "	D'AMICO	
07-56-806	450 mm / 17 ³ / ₄ " Nutzlänge 320 mm / 12 ¹ / ₂ " working length 320 mm / 12 ¹ / ₂ " longueur utile 320 mm / 12 ¹ / ₂ " largura útil 320 mm / 12 ¹ / ₂ " lunghezza utile 320 mm / 12 ¹ / ₂ "	D'AMICO	
07-56-807	310 mm / 12 ¹ / ₄ " Nutzlänge 170 mm / 6 ³ / ₄ " working length 170 mm / 6 ³ / ₄ " longueur utile 170 mm / 6 ³ / ₄ " largura útil 170 mm / 6 ³ / ₄ " lunghezza utile 170 mm / 6 ³ / ₄ "	WOLF	
07-56-809	360 mm / 14 ¹ / ₄ " Nutzlänge 220 mm / 8 ³ / ₄ " working length 220 mm / 8 ³ / ₄ " longueur utile 220 mm / 8 ³ / ₄ " largura útil 220 mm / 8 ³ / ₄ " lunghezza utile 220 mm / 8 ³ / ₄ "	WOLF	
07-56-808	310 mm / 12 ¹ / ₄ " Nutzlänge 170 mm / 6 ³ / ₄ " working length 170 mm / 6 ³ / ₄ " longueur utile 170 mm / 6 ³ / ₄ " largura útil 170 mm / 6 ³ / ₄ " lunghezza utile 170 mm / 6 ³ / ₄ "	WOLF	
07-56-810	360 mm / 14 ¹ / ₄ " Nutzlänge 220 mm / 8 ³ / ₄ " working length 220 mm / 8 ³ / ₄ " longueur utile 220 mm / 8 ³ / ₄ " largura útil 220 mm / 8 ³ / ₄ " lunghezza utile 220 mm / 8 ³ / ₄ "	WOLF	



		Artikel-Nr. Cat. No.	Gesamtlänge Total length
	YANKAUER-BABY	07-56-943	220 mm / 8 ³ / ₄ "
	YANKAUER	07-06-944	285 mm / 11 ¹ / ₄ " mit zentraler Bohrung ø 2,0 mm with central nub ø 2,0 mm avec trou central ø 2,0 mm con cono central ø 2,0 mm con perforazione centrale ø 2,0 mm
	YANKAUER	07-56-945	270 mm / 10 ¹ / ₄ " komplett mit Saugspitze und Schlaucholive complete with suction tip and connector complet avec pointe d'aspiration et raccord completo con punta de succión y conector completo con punta d'aspirazione e raccordo
		07-56-946	Saugspitze Suction Tip · Pointe d'aspiration Cabezal para aspiración · Punta per aspirazione
		07-56-947	Schlaucholive Olive · Olive · Oliva · Oliva
	WALTON YANKAUER	07-56-948	320 mm / 12 ¹ / ₂ " ø 10 mm (30 Charr.) mit Absperrventil und abschraubbarem Rohr with stopcock and tube to be screwed off avec robinet et canule extérieure démontable con interruptor y tubo desenroscable con interruttore e tubo svitabile

Artikel-Nr. Cat. No.	Gesamtlänge Total length	ANDREWS- PYNCHON	
07-56-949	240 mm / 9 ¹ / ₂ " ø 6 mm		
07-06-946	280 mm / 11"	DE BAKEY	
07-06-947 07-06-948	160 mm / 6 ¹ / ₄ " ø 5 mm 270 mm / 10 ³ / ₄ " ø 5 mm Saugkanülen mit Unterbrecher und Mandrin Suction Cannulae with finger cut-off and stylet Canules d'aspiration avec interrupteur à doigt Cánulas para aspiración con interruptor y estilete Cannule per aspirazione con interruttore e stiletto	DE BAKEY	

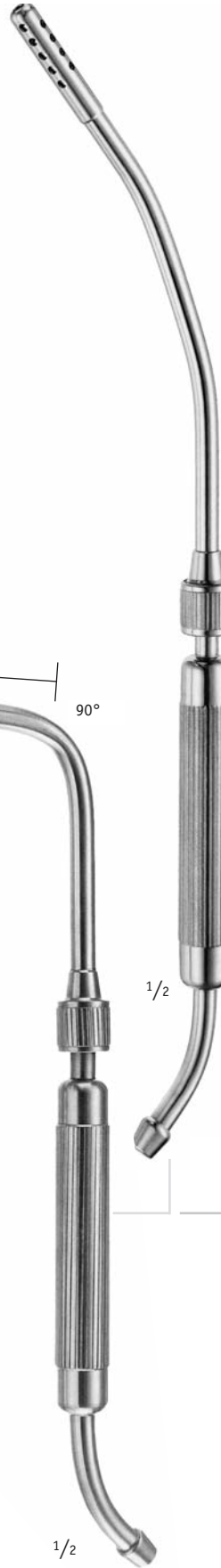
 Artikel-Nr.
 Cat. No.

 Gesamtlänge
 Total length

COOLEY

07-56-803

 330 mm / 13¹/₄"
 ø 8 mm

 130 mm / 5¹/₂"
 90°

1/2

COOLEY

07-56-804



 250 mm / 10"
 ø 9 mm

1/2

Artikel-Nr. Cat. No.	Gesamtlänge Total length	
07-06-867	320 mm / 12 ³ / ₄ "	FINSTERER
Saug- und Spülkanüle <i>Suction and Irrigation Cannula</i> <i>Canule d'aspiration et d'irrigation</i> <i>Cánula para aspiración e irrigación</i> <i>Cannule per aspirazione e irrigazione</i>		

07-56-868	310 mm / 12 ¹ / ₄ "	BRAUN-RALPH
------------------	---	--------------------

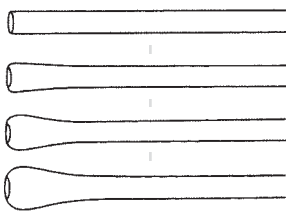

	SCHMID	Artikel-Nr. Cat. No.	Gesamtlänge Total length
		06-02-153 06-02-154 06-02-155 06-02-156	150 mm / 6" ø 3 mm ø 4 mm ø 5 mm ø 6 mm Gefäßspülkanülen versilbert, biegsam, mit Luer-Lock Ansatz <i>Vascular irrigation Cannulae</i> <i>silver plated, malleable, with Luer-Lock connection</i> <i>Aiguilles vasculaires pour irrigation</i> <i>argentées, malléables, avec cône Luer-Lock</i> <i>Cánulas vasculares para irrigación</i> <i>plateadas, maleables, con conexión Luer-Lock</i> <i>Aghi vascolari per irrigazione</i> <i>argentati, malleabili, attacco Luer-Lock</i>
	ADSON	07-56-900	210 mm / 8 ¹ / ₄ " ø 4 mm Saugkanülen mit Unterbrecher und Mandrin <i>Suction Cannulae with finger cut-off and stylet</i> <i>Canules d'aspiration avec interrupteur à doigt</i> <i>Cánulas para aspiración con interruptor y estilete</i> <i>Cannule per aspirazione con interruttore e stiletto</i>
	ADSON	07-56-902	210 mm / 8 ¹ / ₄ " ø 4 mm Saugkanülen mit Unterbrecher und Mandrin <i>Suction Cannulae with finger cut-off and stylet</i> <i>Canules d'aspiration avec interrupteur à doigt</i> <i>Cánulas para aspiración con interruptor y estilete</i> <i>Cannule per aspirazione con interruttore e stiletto</i>

Artikel-Nr. Cat. No.	Gesamtlänge Total length
07-06-939	195 mm / 7 ³ / ₄ " ø 1,5 mm
07-06-940	195 mm / 7 ³ / ₄ " ø 2 mm
07-06-941	195 mm / 7 ³ / ₄ " ø 2,5 mm
07-06-942	195 mm / 7 ³ / ₄ " ø 3 mm

mit Saugunterbrecher und Mandrin, LUER-Bohrung
 with finger cut-off and stylet, LUER hub
 avec interrupteur à doigt, avec trou LUER
 con interruptor y estilete, con cono LUER
 con interruttore e stiletto, con perforazione LUER

PLESTER



1/2

07-56-915	130 mm / 5" ø 1,6 mm
07-56-916	130 mm / 5" ø 2 mm
07-56-917	130 mm / 5" ø 2,3 mm
07-56-918	130 mm / 5" ø 2,7 mm
07-56-919	130 mm / 5" ø 3 mm
07-56-920	130 mm / 5" ø 3,3 mm
07-56-921	130 mm / 5" ø 4 mm
07-56-922	130 mm / 5" ø 5 mm

mit Saugunterbrecher und Mandrin, LUER-Bohrung
 with finger cut-off and stylet, LUER hub
 avec interrupteur à doigt, avec trou LUER
 con interruptor y estilete, con cono LUER
 con interruttore e stiletto, con perforazione LUER

POPPEN



2/3



1/2

 Artikel-Nr.
 Cat. No.

 Gesamtlänge
 Total length

180 mm / 7 1/4"

FRAZIER**07-06-927**

F.G. Charr. 6, ø 2,0 mm, 30°

07-56-927

F.G. Charr. 7, ø 2,3 mm, 30°

07-06-928

F.G. Charr. 8, ø 2,7 mm, 30°

07-06-929

F.G. Charr. 9, ø 3,0 mm, 30°

07-56-930

F.G. Charr. 10, ø 3,3 mm, 30°

07-56-931

F.G. Charr. 11, ø 3,7 mm, 30°

07-06-930

F.G. Charr. 12, ø 4,0 mm, 30°

07-06-931

F.G. Charr. 15, ø 5,0 mm, 30°

Saugkanülen mit Unterbrecher und Mandrin
 Suction Cannulae with finger cut-off and stylet
 Canules d'aspiration avec interrupteur à doigt
 Cánulas para aspiración con interruptor y estilete
 Cannule per aspirazione con interruttore e stiletto

180 mm / 7 1/4"

FRAZIER**07-56-933**

F.G. Charr. 6, ø 2,0 mm, 75°

07-56-934

F.G. Charr. 7, ø 2,3 mm, 75°

07-56-935

F.G. Charr. 8, ø 2,7 mm, 75°

07-56-936

F.G. Charr. 9, ø 3,0 mm, 75°

07-56-937

F.G. Charr. 10, ø 3,3 mm, 75°

07-56-938

F.G. Charr. 11, ø 3,7 mm, 75°







07-56-939

F.G. Charr. 12, ø 4,0 mm, 75°

07-56-940

F.G. Charr. 15, ø 5,0 mm, 75°

Saugkanülen mit Unterbrecher und Mandrin
 Suction Cannulae with finger cut-off and stylet
 Canules d'aspiration avec interrupteur à doigt
 Cánulas para aspiración con interruptor y estilete
 Cannule per aspirazione con interruttore e stiletto

Artikel-Nr. Cat. No.	Gesamtlänge Total length			
07-56-850	1,2 x 80 mm			
07-56-851	1,5 x 80 mm			
Venenkanülen, Knopfende mit Schlaucholive Vein Cannulae, button end with tube connector Canules veineuses, aboutonné avec connection pour tubes Cánulas para venas, abotonado con conexión para tubos Cannule per vene, a bottone con raccordo per tubi				
07-56-852	4,0 x 150 mm	DE BAKEY		
07-56-853	8,0 x 109 mm	GARRETT		
07-56-854	15,0 x 120 mm			
Heparininjektor, biegsam, LUER-LOCK Ansatz Heparin Injector, malleable, LUER-LOCK connection Injecteur pour héparine, malléable, connection LUER-LOCK Iniettore per eparina, malleabili, raccordo LUER-LOCK				
07-56-855	1,5 x 53 mm	I.M.A.		
07-56-856	2,0 x 45 mm			
07-56-857	3,0 x 45 mm			
07-56-858	3,7 x 54 mm	ZANGER		
07-56-859	4,0 x 63 mm			
07-56-860	5,0 x 160 mm			
07-56-861	3,0 x 65 mm	MOCK (DE BAKEY)		

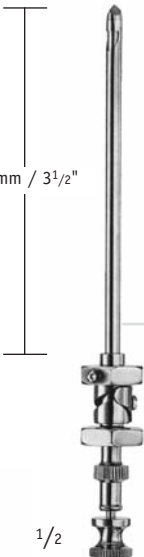

90 mm / 3 1/2"

ABRAMS
 Artikel-Nr.
 Cat. No.
05-10-183
 Gesamtlänge
 Total length

 ø 4 mm (8 G)
 140 mm / 5 1/2"

 Pleurabiopsie-Nadel, mit LUER-LOCK Ansatz
Pleural Biopsy Needle, with LUER-LOCK connection
Aiguille de biopsie pleurale, avec cône LUER-LOCK
Aguja de la biopsia pleural, con conexión LUER-LOCK
Ago per biopsia pleurica, attacco LUER-LOCK

1/2

RAMEL**05-60-184**

ø 3 mm (11 G)



65 mm / 2 1/2"

1/2

COPE**05-60-185**

ø 3 mm (11 G)

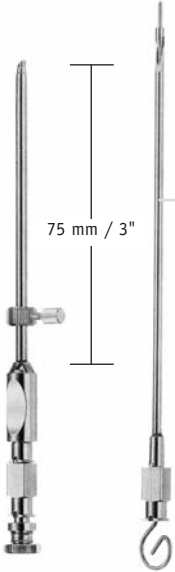

75 mm / 3"

1/2

Brustfell-Trokare, Pleurabiopsie-Nadel

Thoracic trocars, Pleural Biopsy Needle · Trocars, Aiguille de biopsie pleurale · Trócares, Aguja de la biopsia pleural · Trequarti, Ago per biopsia pleurica

Artikel-Nr. Cat. No.	Trokare Trocars	für Katheter for catheters
05-10-192	10 Charr.	6 Charr.
05-10-194	12 Charr.	8 Charr.
05-60-195	14 Charr.	10 Charr.
05-10-196	16 Charr.	12 Charr.
05-10-198	18 Charr.	14 Charr.
05-60-199	20 Charr.	16 Charr.
05-60-200	22 Charr.	18 Charr.
05-60-201	24 Charr.	20 Charr.
05-60-202	28 Charr.	24 Charr.

OCHSNER

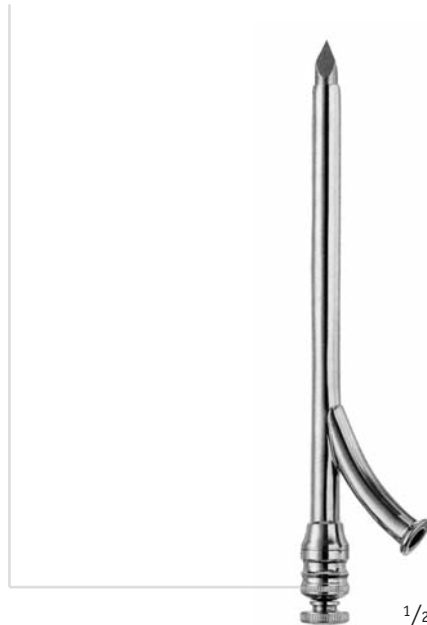

Artikel-Nr. Cat. No.	Außen-Ø Outer Ø	Innen-Ø Inner Ø
	200 mm / 8"	
05-60-203	8,3 mm / 25 Charr.	7,3 mm
05-60-204	10 mm / 30 Charr.	9,0 mm
05-60-205	11 mm / 33 Charr.	10 mm
05-60-206	11,7 mm / 35 Charr.	10,7 mm

NELSON





STANDARD

 Artikel-Nr.
 Cat. No.

 Artikel-Nr.
 Cat. No.

 Gesamtlänge
 Total length

 02-53-311
 02-53-312
 02-03-313

 02-53-230
 02-53-232

 105 mm / 4¹/₄"
 115 mm / 4¹/₂"
 130 mm / 5¹/₈"

 02-03-314
 02-03-315
 02-03-316

 02-53-230
 02-53-232

 145 mm / 5³/₄"
 150 mm / 6"
 165 mm / 6¹/₂"

 02-03-317
 02-53-318
 02-53-319

 02-53-234
 02-53-236

 175 mm / 7"
 185 mm / 7¹/₄"
 200 mm / 8"

STANDARD

 02-53-410
 02-03-411
 02-03-413

 02-53-231
 02-53-233

 105 mm / 4¹/₄"
 115 mm / 4¹/₂"
 130 mm / 5¹/₈"

 02-03-414
 02-03-415
 02-03-416

 02-03-231
 02-53-233

 145 mm / 5³/₄"
 150 mm / 6"
 165 mm / 6¹/₂"

 02-03-417
 02-53-418
 02-53-419

 02-53-235
 02-53-237

 175 mm / 7"
 185 mm / 7¹/₄"
 200 mm / 8"

TC
STANDARD
Supercut
 02-53-040
 02-53-041
 02-53-042

 02-53-056
 02-53-057

 105 mm / 4¹/₄"
 115 mm / 4¹/₂"
 130 mm / 5"

 02-53-043
 02-53-044
 02-53-045

 02-53-056
 02-53-057

 145 mm / 5³/₄"
 150 mm / 6"
 165 mm / 6¹/₂"

 02-53-046
 02-53-047

 02-53-056
 02-53-057

 185 mm / 7¹/₄"
 200 mm / 8"
STANDARD
Supercut
 02-53-048
 02-53-049
 02-53-050

 02-53-058
 02-53-059

 105 mm / 4¹/₄"
 115 mm / 4¹/₂"
 130 mm / 5"

 02-53-051
 02-53-052
 02-53-053

 02-53-058
 02-53-059

 145 mm / 5³/₄"
 150 mm / 6"
 165 mm / 6¹/₂"

 02-53-054
 02-53-055

 02-53-058
 02-53-059

 185 mm / 7¹/₄"
 200 mm / 8"

 1/2
 SUPERCUT

Artikel-Nr. Cat. No.	Artikel-Nr. Cat. No.	Gesamtlänge Total length
02-03-320		105 mm / 4 ¹ / ₄ "
02-03-321		115 mm / 4 ¹ / ₂ "
02-03-323		130 mm / 5"
02-03-324	02-03-224	145 mm / 5 ³ / ₄ "
02-03-325		150 mm / 6"
02-03-326		165 mm / 6 ¹ / ₂ "
02-03-327	02-53-206	175 mm / 7"
02-03-328		185 mm / 7 ¹ / ₄ "
02-03-330		200 mm / 8"

STANDARD



02-53-420		105 mm / 4 ¹ / ₄ "
02-03-421		115 mm / 4 ¹ / ₂ "
02-03-423		130 mm / 5"
02-03-424	02-03-234	145 mm / 5 ³ / ₄ "
02-03-425		150 mm / 6"
02-03-426		165 mm / 6 ¹ / ₂ "
02-03-427	02-53-207	175 mm / 7"
02-03-428		185 mm / 7 ¹ / ₄ "
02-53-429		200 mm / 8"

STANDARD

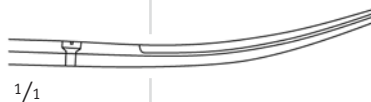

TC

02-53-060	02-53-074	115 mm / 4 ¹ / ₂ "
02-53-061		130 mm / 5"
02-53-062		145 mm / 5 ³ / ₄ "
02-53-063	02-53-075	150 mm / 6"
02-53-064		165 mm / 6 ¹ / ₂ "
02-53-065		185 mm / 7 ¹ / ₄ "
02-53-066		200 mm / 8"

STANDARD
Supercut



02-53-067	02-53-076	115 mm / 4 ¹ / ₂ "
02-53-068		130 mm / 5"
02-53-069		145 mm / 5 ³ / ₄ "
02-53-070	02-53-077	150 mm / 6"
02-53-071		165 mm / 6 ¹ / ₂ "
02-53-072		185 mm / 7 ¹ / ₄ "
02-53-073		200 mm / 8"

STANDARD
Supercut



 Artikel-Nr.
 Cat. No.

 Artikel-Nr.
 Cat. No.

 Gesamtlänge
 Total length

 02-53-340
 02-03-341
 02-03-343

 02-03-228
 02-53-200

 105 mm / 4¹/₄"
 115 mm / 4¹/₂"
 130 mm / 5"

 02-03-344
 02-03-345
 02-03-346

 02-03-228
 02-53-200

 145 mm / 5³/₄"
 150 mm / 6"
 165 mm / 6¹/₂"

 02-53-347
 02-53-348
 02-53-349

 02-53-202
 02-53-204

 175 mm / 7"
 185 mm / 7¹/₄"
 200 mm / 8"

STANDARD

 02-53-440
 02-03-441
 02-03-443

 02-53-199
 02-53-201

 105 mm / 4¹/₄"
 115 mm / 4¹/₂"
 130 mm / 5"

 02-03-444
 02-03-445
 02-53-446

 02-53-199
 02-53-201

 145 mm / 5³/₄"
 150 mm / 6"
 165 mm / 6¹/₂"

 02-53-447
 02-53-448
 02-53-449

 02-53-203
 02-53-205

 175 mm / 7"
 185 mm / 7¹/₄"
 200 mm / 8"

TC

 STANDARD
 Supercut

 02-53-080
 02-53-081
 02-53-082

 02-53-096
 02-53-097

 105 mm / 4¹/₄"
 115 mm / 4¹/₂"
 130 mm / 5"

 02-53-083
 02-53-084
 02-53-085

 02-53-096
 02-53-097

 145 mm / 5³/₄"
 150 mm / 6"
 165 mm / 6¹/₂"

 02-53-086
 02-53-087

 02-53-096
 02-53-097

 185 mm / 7¹/₄"
 200 mm / 8"

 STANDARD
 Supercut

 02-53-088
 02-53-089
 02-53-090

 02-53-098
 02-53-099

 105 mm / 4¹/₄"
 115 mm / 4¹/₂"
 130 mm / 5"

 02-53-091
 02-53-092
 02-53-093

 02-53-098
 02-53-099

 145 mm / 5³/₄"
 150 mm / 6"
 165 mm / 6¹/₂"

 02-53-094
 02-53-095

 02-53-098
 02-53-099

 185 mm / 7¹/₄"
 200 mm / 8"

SUPERCUT

Artikel-Nr. Cat. No.	Artikel-Nr. Cat. No.	Gesamtlänge Total length
02-03-544	02-03-250	140 mm / 5 ¹ / ₂ "
02-03-545		155 mm / 6"
02-03-547	02-03-252	170 mm / 6 ³ / ₄ "
02-53-548		190 mm / 7 ¹ / ₂ "
02-53-549	02-53-254	230 mm / 9"
02-53-550		280 mm / 11"

MAYO

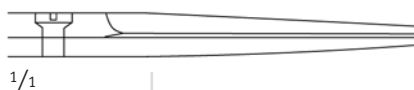

1/1

02-03-554	02-03-251	140 mm / 5 ¹ / ₂ "
02-03-555		155 mm / 6"
02-03-557	02-03-253	170 mm / 6 ³ / ₄ "
02-53-558		190 mm / 7 ¹ / ₂ "
02-53-559	02-53-255	230 mm / 9"
02-53-560		280 mm / 11"

MAYO



1/1



1/2

TC

02-53-466	02-53-477	140 mm / 5 ¹ / ₂ "
02-53-467	02-53-478	170 mm / 6 ³ / ₄ "
02-53-475	02-53-479	230 mm / 9"

MAYO
Supercut

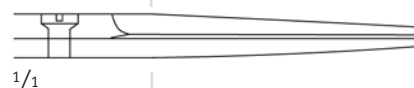

1/1

02-53-468	02-53-480	140 mm / 5 ¹ / ₂ "
02-53-469		170 mm / 6 ³ / ₄ "
02-53-476	02-53-481	230 mm / 9"

MAYO
Supercut



1/1



1/2

SUPERCUT

MAYO-STILLE

 Artikel-Nr.
 Cat. No.

 Artikel-Nr.
 Cat. No.

 Gesamtlänge
 Total length

02-03-570

02-53-278

140 mm / 5¹/₂"

02-03-572

02-53-280

170 mm / 6³/₄"

02-53-574

200 mm / 8"

02-53-576

210 mm / 8¹/₄"

1/1

MAYO-STILLE

02-03-573

02-53-279

140 mm / 5¹/₂"

02-03-575

02-53-281

170 mm / 6³/₄"

02-53-577

200 mm / 8"

02-53-579

210 mm / 8¹/₄"

1/1

TC

LEXER-FINO

02-53-590

160 mm / 6¹/₄"

1/1

LEXER-FINO

02-53-591

160 mm / 6¹/₄"

1/1

1/2

Artikel-Nr. Cat. No.	Artikel-Nr. Cat. No.	Gesamtlänge Total length
02-03-590	02-53-282	165 mm / 6 ¹ / ₂ "
02-53-592	02-53-284	210 mm / 8 ¹ / ₄ "
02-03-591	02-03-283	165 mm / 6 ¹ / ₂ "
02-53-593	02-53-285	210 mm / 8 ¹ / ₄ "

LEXER

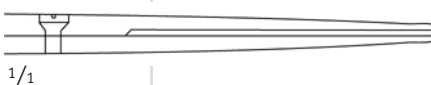

1/1

LEXER



1/1



1/2

TC

02-53-580	02-53-584	165 mm / 6 ¹ / ₄ "
02-53-581	02-53-585	210 mm / 6 ¹ / ₄ "
02-53-582	02-53-586	165 mm / 6 ¹ / ₄ "
02-53-583	02-53-587	210 mm / 6 ¹ / ₄ "

LEXER
Supercut



1/1

LEXER
Supercut

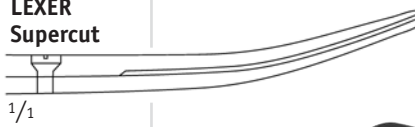

1/1



1/2

SUPERCUT

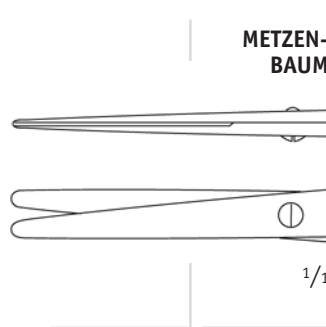

1/2

**METZEN-BAUM**Artikel-Nr.
Cat. No.Artikel-Nr.
Cat. No.Gesamtlänge
Total length

02-53-599

02-03-256

115 mm / 4 1/2"

02-03-601

02-03-260

145 mm / 5 3/4"

02-03-602

02-03-262

180 mm / 7"

02-03-604

02-03-274

200 mm / 8"

02-03-611

02-03-276

230 mm / 9"

02-03-612

02-53-276

250 mm / 10"

02-03-613

02-53-286

280 mm / 11"

02-03-614

02-53-288

300 mm / 12"

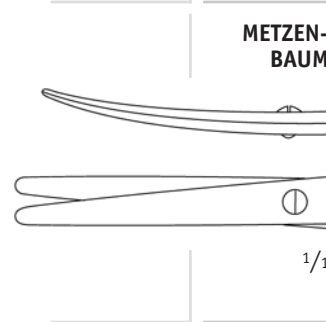
**METZEN-BAUM**

02-53-601

02-03-257

115 mm / 4 1/2"

02-03-605

02-03-261

145 mm / 5 3/4"

02-03-606

02-03-263

180 mm / 7"

02-03-607

02-03-265

200 mm / 8"

02-03-615

02-03-277

230 mm / 9"

02-03-616

02-03-279

250 mm / 10"

02-03-618

02-03-281

280 mm / 11"

02-03-619

02-03-289

300 mm / 12"

TC



1/2

SUPERCUT

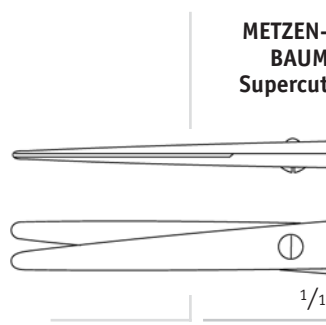
**METZEN-BAUM
Supercut**

02-53-130

02-53-143

115 mm / 4 1/2"

02-53-131

02-53-144

145 mm / 5 3/4"

02-53-132

02-53-145

180 mm / 7"

02-53-133

02-53-146

200 mm / 8"

02-53-134

02-53-147

230 mm / 9"

02-53-135

02-53-148

250 mm / 10"

02-53-136

02-53-149

280 mm / 11"

02-53-137

02-53-150

300 mm / 12"

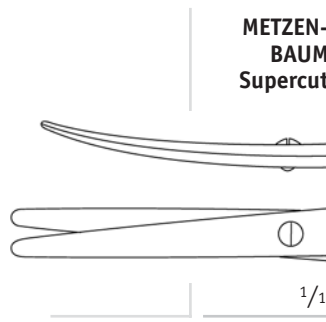
**METZEN-BAUM
Supercut**

02-53-138

02-53-151

115 mm / 4 1/2"

02-53-430

02-53-152

145 mm / 5 3/4"

02-53-431

02-53-153

180 mm / 7"

02-53-432

02-53-154

200 mm / 8"

02-53-139

02-53-155

230 mm / 9"

02-53-140

02-53-156

250 mm / 10"

02-53-141

02-53-157

280 mm / 11"

02-53-142

02-53-158

300 mm / 12"

Artikel-Nr. Cat. No.	Artikel-Nr. Cat. No.	Gesamtlänge Total length
02-53-620	02-53-630	145mm / 5 ³ / ₄ "
02-53-622	02-53-632	180 mm / 7"
02-53-624	02-53-634	200 mm / 8"
02-53-626	02-53-636	230 mm / 9"
02-53-628	02-53-638	250 mm / 10"
02-53-610	02-53-612	280 mm / 11"

**METZEN-
BAUM
FINO**



1/1

02-53-621	02-53-631	145 mm / 5 ³ / ₄ "
02-53-623	02-53-633	180 mm / 7"
02-53-625	02-53-635	200 mm / 8"
02-53-627	02-53-637	230 mm / 9"
02-53-629	02-53-639	250 mm / 10"
02-53-611	02-53-613	280 mm / 11"

**METZEN-
BAUM
FINO**



1/1



1/2

TC

02-53-490	02-53-500	145mm / 5 ³ / ₄ "
02-53-491	02-53-501	180 mm / 7"
02-53-492	02-53-502	200 mm / 8"
02-53-493	02-53-503	230 mm / 9"
02-53-494	02-53-504	250 mm / 10"
02-53-495	02-53-505	280 mm / 11"

**METZEN-
BAUM FINO
Supercut**

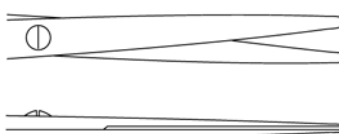

1/1

02-53-462	02-53-506	145 mm / 5 ³ / ₄ "
02-53-463	02-53-507	180 mm / 7"
02-53-464	02-53-508	200 mm / 8"
02-53-496	02-53-509	230 mm / 9"
02-53-497	02-53-510	250 mm / 10"
02-53-498	02-53-511	280 mm / 11"

**METZEN-
BAUM FINO
Supercut**



1/1



1/2

SUPERCUT

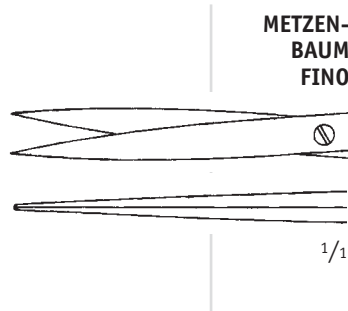
**METZEN-
BAUM
FINO**

 Artikel-Nr.
Cat. No.

 Artikel-Nr.
Cat. No.

 Gesamtlänge
Total length

02-53-520

02-53-528

140 mm / 5 1/2"

02-53-521

02-53-529

180 mm / 7"

02-53-522

02-53-530

200 mm / 8"

02-53-523

02-53-531

230 mm / 9"

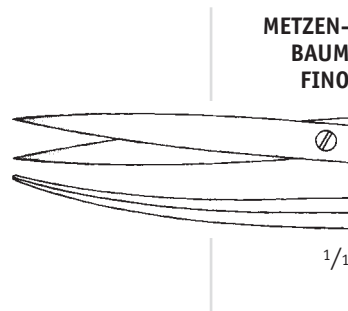
TC

**METZEN-
BAUM
FINO**

02-53-524

02-53-532

140 mm / 5 1/2"

02-53-525

02-53-533

180 mm / 7"

02-53-526

02-53-534

200 mm / 8"

02-53-527

02-53-535

230 mm / 9"

Artikel-Nr. Cat. No.	Artikel-Nr. Cat. No.	Gesamtlänge Total length
02-53-514	02-53-515	180 mm / 7"
	TC	



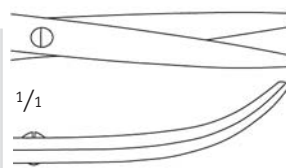



**METZEN-
BAUM FINO
"S"**

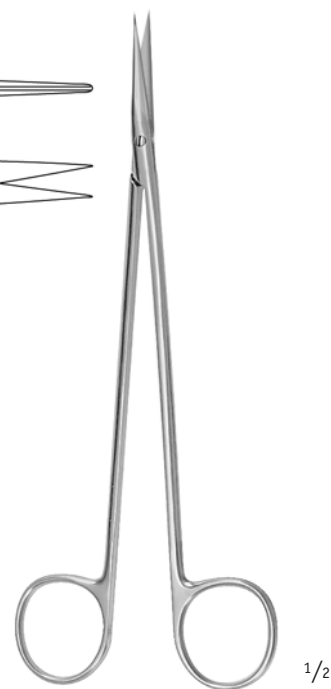
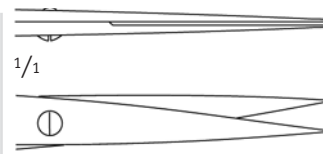

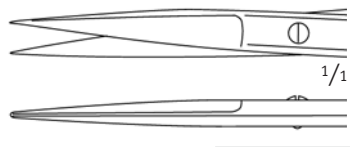
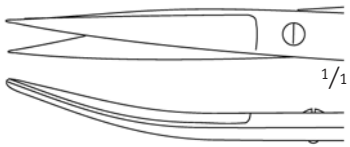
02-53-516		180 mm / 7"
02-53-517		200 mm / 8"

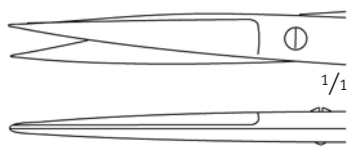
**METZEN-
BAUM
NELSON**



 1/2	 1/1	SANVENERO	02-53-126		140 mm / 5 1/2"
	 1/1	SANVENERO	02-53-127		140 mm / 5 1/2"
 1/2	 1/1	JOSEPH	02-03-156		150 mm / 6"
	 1/1	JOSEPH	02-03-157		150 mm / 6"
 1/2	 1/1	KILNER	02-03-166	02-53-266	125 mm / 5"
	 1/1		02-03-168	02-53-268	150 mm / 6"
				TC	

Artikel-Nr. Cat. No.	Artikel-Nr. Cat. No.	Gesamtlänge Total length
02-53-178	02-53-179	145 mm / 5 ³ / ₄ "

REYNOLDS

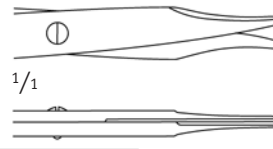

02-03-180	02-53-180	145 mm / 5 ³ / ₄ "
02-03-181		175 mm / 7"

REYNOLDS

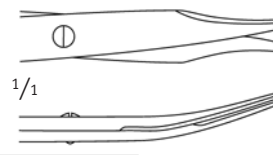

TC

02-03-100	02-03-210	90 mm / 3 ¹ / ₂ "
02-03-110		110 mm / 4 ³ / ₈ "
02-03-106		115 mm / 4 ¹ / ₂ "
02-03-064		120 mm / 4 ³ / ₄ "



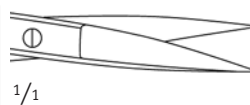

IRIS

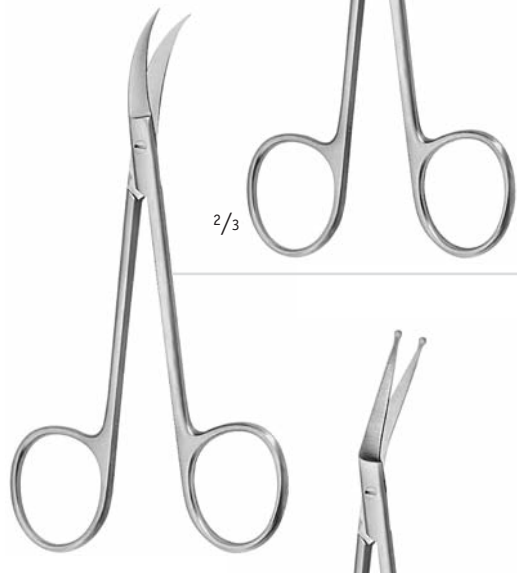

02-03-101	02-03-211	90 mm / 3 ¹ / ₂ "
02-03-111		110 mm / 4 ³ / ₈ "
02-03-107		115 mm / 4 ¹ / ₂ "
02-03-065		120 mm / 4 ³ / ₄ "

IRIS

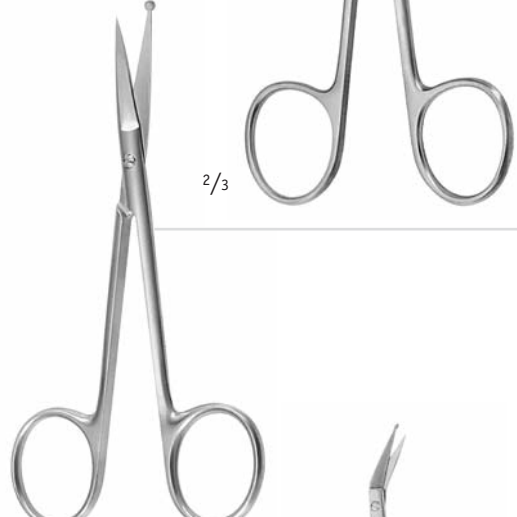

		Artikel-Nr. Cat. No.	Gesamtlänge Total length
	IRIS	02-03-117	110 mm / 4 ³ / ₈ "
	IRIS	02-53-032	115 mm / 4 ¹ / ₂ "
	IRIS	02-03-033	115 mm / 4 ¹ / ₂ "
	PER- WITZCHKY	02-03-030	115 mm / 4 ¹ / ₂ "
	PER- WITZCHKY	15-13-489	100 mm / 4"

Artikel-Nr.
 Cat. No.

Gesamtlänge
 Total length

02-53-035

150 mm / 6"

spitz
 pointed · pointu · aguda · acuta

BEAL
Circumflex

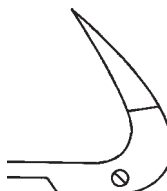

$\frac{1}{1}$
 115°

02-53-036

150 mm / 6"

stumpf
 blunt · mousse · roma · smusso

BEAL
Circumflex



$\frac{1}{1}$
 115°

02-53-037

190 mm / 7 $\frac{1}{2}$ "

POTTS
SMITH

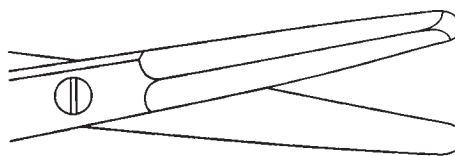

$\frac{1}{1}$



$\frac{1}{2}$

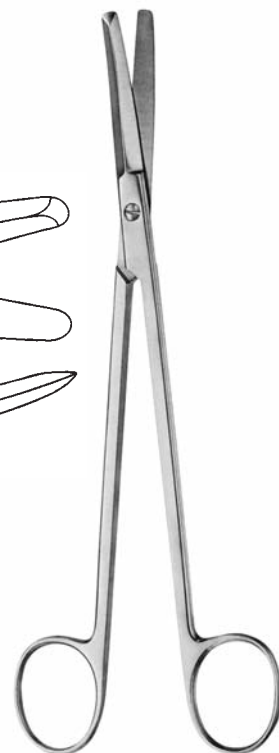

$\frac{1}{2}$

 Artikel-Nr.
 Cat. No.

 Gesamtlänge
 Total length

02-03-642

225 mm / 9"

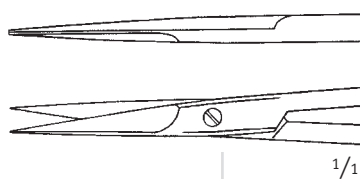
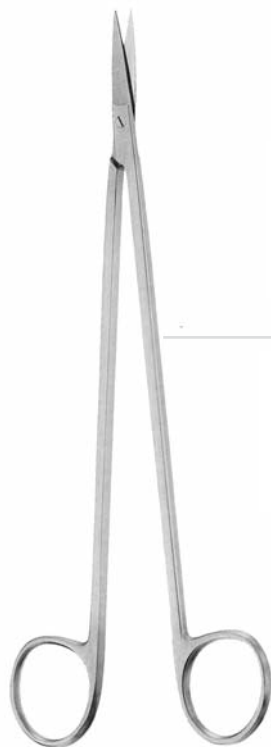
 spitz / spitz
 sharp / sharp · pointue / pointue
 aguda / aguda · acuta / acuta

02-53-038

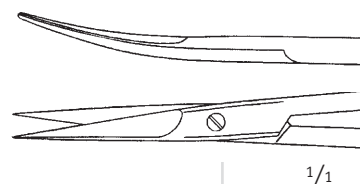
190 mm / 7 1/2"

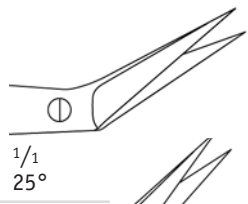
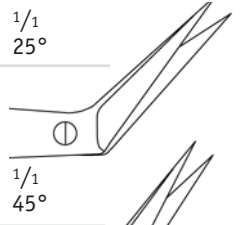
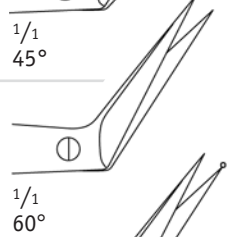
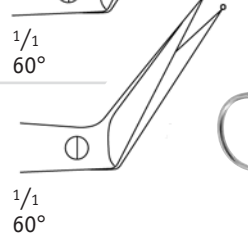

02-53-039

190 mm / 7 1/2"

Artikel-Nr. Cat. No.	TC	Gesamtlänge Total length		
02-03-647	02-53-658	185 mm / 7 ¹ / ₄ "	POTTS-DE MARTELL	
02-03-648	02-53-659	185 mm / 7 ¹ / ₄ "	POTTS-DE MARTELL	
02-03-649	02-53-660	185 mm / 7 ¹ / ₄ "	POTTS-DE MARTELL	
02-03-651		220 mm / 8 ³ / ₄ "	MILLS	

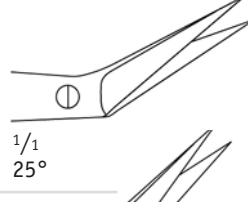
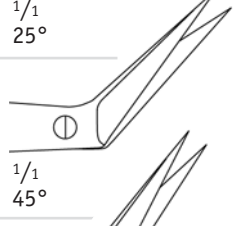
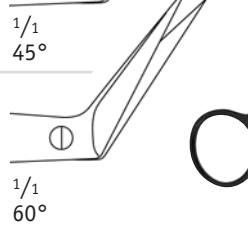

02-53-680	02-53-683	185 mm / 7 ¹ / ₄ "	POTTS-DE MARTELL Supercut	
02-53-681	02-53-684	185 mm / 7 ¹ / ₄ "	POTTS-DE MARTELL Supercut	
02-53-682	02-53-685	185 mm / 7 ¹ / ₄ "	POTTS-DE MARTELL Supercut	

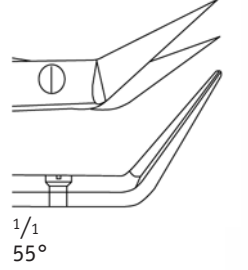

	TC			
02-03-646		180 mm / 7"	POTTS-SMITH	

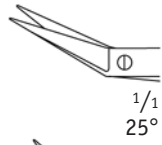
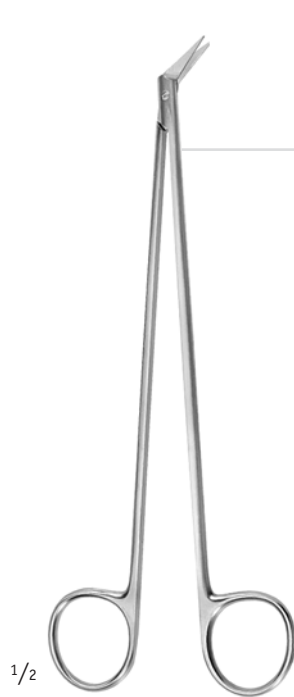

**DIETHRICH-HEGEMANN**
 Artikel-Nr.
 Cat. No.

02-03-662

 Gesamtlänge
 Total length

180 mm / 7"

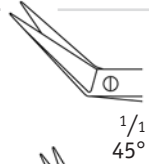
**DIETHRICH-HEGEMANN**

02-03-663

180 mm / 7"

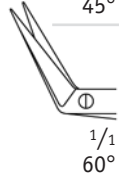
**DIETHRICH-HEGEMANN**

02-03-664

180 mm / 7"

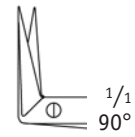
**DIETHRICH-HEGEMANN**

02-03-653

180 mm / 7"

**DIETHRICH-HEGEMANN**

02-03-654

180 mm / 7"

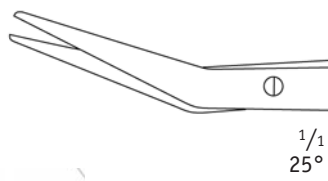
**DE BAKEY**

02-53-661

02-53-655

160 mm / 6¹/₄"

02-53-690

02-53-693

180 mm / 7"

02-53-662

02-53-694

230 mm / 9"

02-53-663

280 mm / 11"

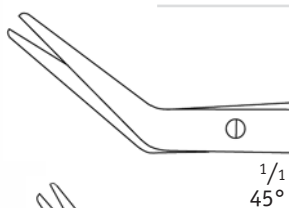
**DE BAKEY**

02-53-664

02-53-656

160 mm / 6¹/₄"

02-53-691

02-53-695

180 mm / 7"

02-53-665

02-53-696

230 mm / 9"

02-53-666

02-53-697

280 mm / 11"

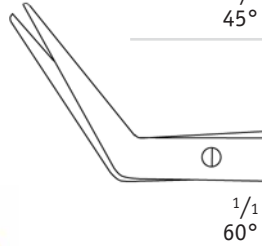
**DE BAKEY**

02-53-667

02-53-657

160 mm / 6¹/₄"

02-53-692

02-53-698

180 mm / 7"

02-53-668

02-03-245

230 mm / 9"

02-53-669

280 mm / 11"

TC

Artikel-Nr. Cat. No.	Gesamtlänge Total length
02-53-673	180 mm / 7"

DIETRICH



02-03-650	210 mm / 8 $\frac{1}{4}$ "
02-53-674	240 mm / 9 $\frac{1}{2}$ "

POTTS-DE MARTEL

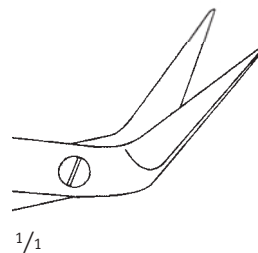

02-03-652	180 mm / 7"
-----------	-------------

POTTS-SMITH

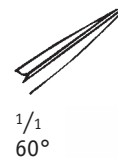

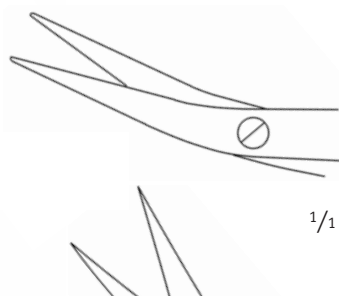
**DE BAKEY**
 Artikel-Nr.
 Cat. No.
02-53-679
 Gesamtlänge
 Total length

155 mm / 6"

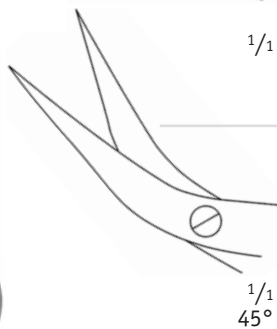
 Offsetschere
 Offset scissors · Ciseaux compensé
 Tijeras compensar · Forbici compensare
**DE BAKEY****02-03-669**

155 mm / 6"

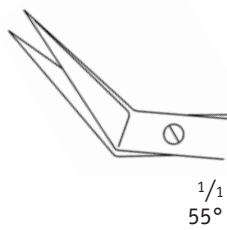
 Offsetschere
 Offset scissors · Ciseaux compensé
 Tijeras compensar · Forbici compensare
**FAVALORO****02-03-670**

140 mm / 5 1/2"

 Coronararterien-Schere
 Coronary artery scissors
 Ciseaux artère coronaire
 Tijeras de la arteria coronaria
 Forbici per arterie coronarica

Artikel-Nr.
 Cat. No.

Gesamtlänge
 Total length

02-03-273

175 mm / 7"

TOENNIS-ADSON

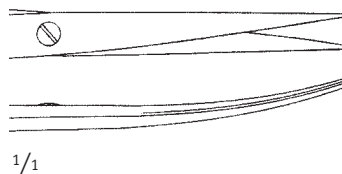

TC

02-03-644

220 mm / 8³/₄"

spitz
 pointed · pointu · aguda · acuta

STRULLY

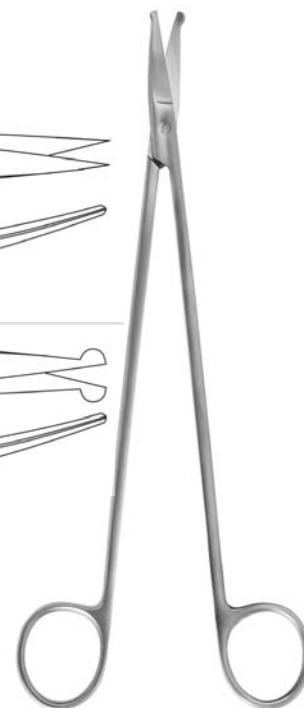
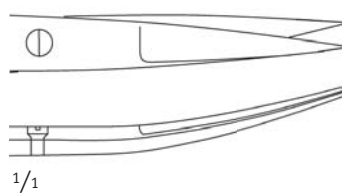

02-03-645

220 mm / 8³/₄"

geknöpft
 probe pointed · sonde boutonnée
 punta de prueba abotonada · sonda abbottonata

STRULLY

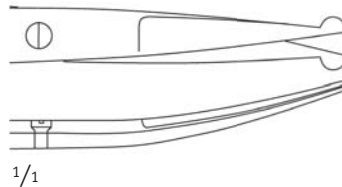



1/2

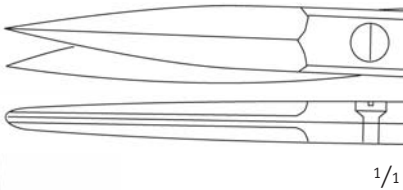

1/1

MC INDOE

 Artikel-Nr.
 Cat. No.

02-03-672

 Gesamtlänge
 Total length

190 mm / 7½"

 Knorpelschere, gezahnt
 Cartilage Scissors, toothed
 Ciseaux pour cartilage, dentelé
 Tijera para cartilago, dentada
 Forbici per cartilagini, dentata

1/2



1/1

02-53-670

150 mm / 6"

 Nerv-Präparierschere
 Nerve dissecting scissors
 Ciseaux à préparation de nerfs
 Tijera para preparación del nervio
 Forbici per preparazione di nervi

1/1

02-03-628

150 mm / 6"

 Nerv-Präparierschere
 Nerve dissecting scissors
 Ciseaux à préparation de nerfs
 Tijera para preparación del nervio
 Forbici per preparazione di nervi



Artikel-Nr.
 Cat. No.

Schaftlänge
 Length of shaft

	In-situ-Venenklappe Schere <i>In-situ venous valve scissors</i> <i>In-situ ciseaux valve veineuse</i> <i>In-situ tijeras de la válvula venosa</i> <i>In-situ forbici valvole venose</i>	
02-53-700	100 mm / 4" gerade <i>straight · droite · recta · dritto</i>	
02-53-701	230 mm / 9" gerade <i>straight · droite · recta · dritto</i>	
02-53-702	300 mm / 12" gerade <i>straight · droite · recta · dritto</i>	
02-53-703	300 mm / 12" für den linken Oberschenkel <i>for left thigh · pour la cuisse gauche</i> <i>de muslo izquierdo · per coscia sinistra</i>	
02-53-704	300 mm / 12" für den rechten Oberschenkel <i>for right thigh · pour la cuisse droite</i> <i>para el muslo derecho · per coscia destra</i>	

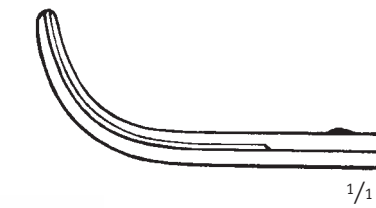
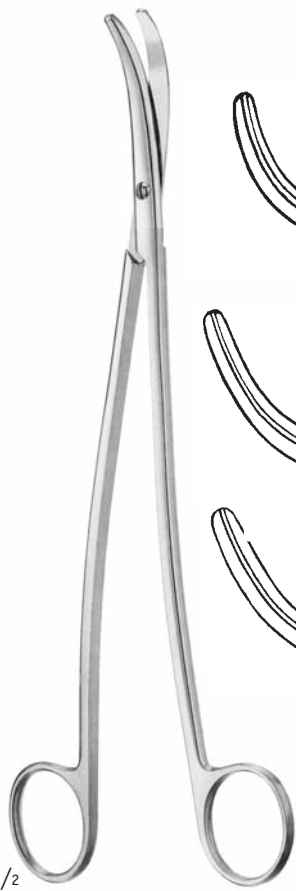

**HOHEN-
FELLNER**

 Artikel-Nr.
Cat. No.

02-53-705

 Gesamtlänge
Total length

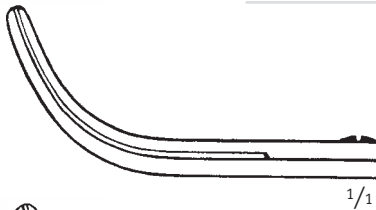
180 mm / 7"

**HOHEN-
FELLNER**
02-53-706

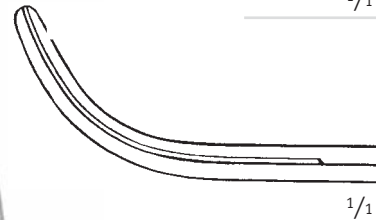
 210 mm / 8¹/₄"

**HOHEN-
FELLNER**
02-53-707

 240 mm / 9¹/₂"

Artikel-Nr. Cat. No.	Gesamtlänge Total length
02-53-708	180 mm / 7"

SATINSKY



1/2

02-53-709	210 mm / 8 1/4"
-----------	-----------------

SATINSKY



1/2

02-03-641	245 mm / 9 1/4"
-----------	-----------------

für die Vena Cava
 for Vena Cava · pour la veine cave
 para la vena cava · per la vena cava

SATINSKY

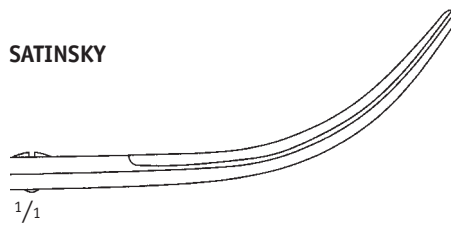

1/1

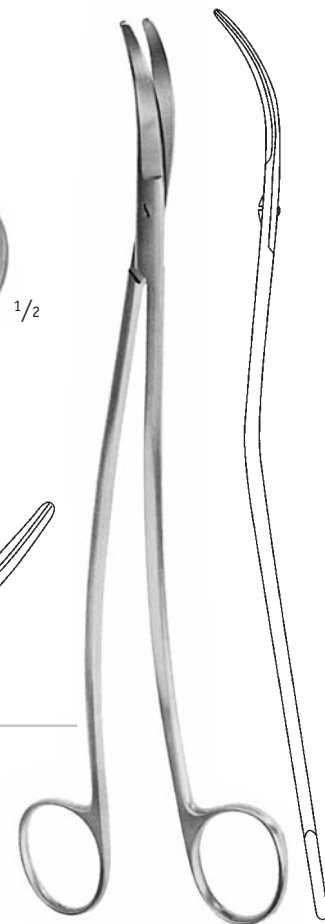

1/2

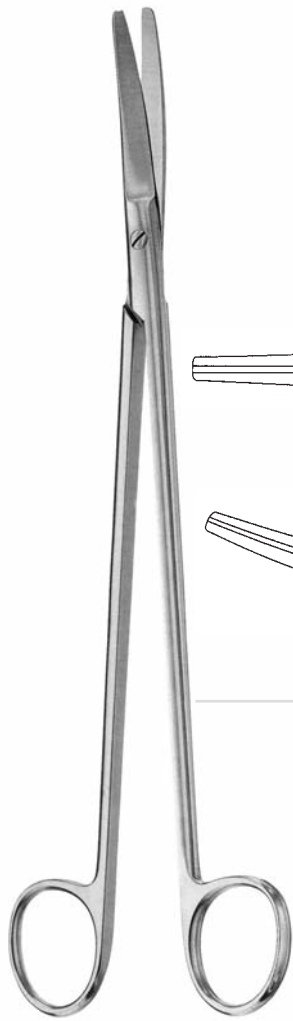

1/2

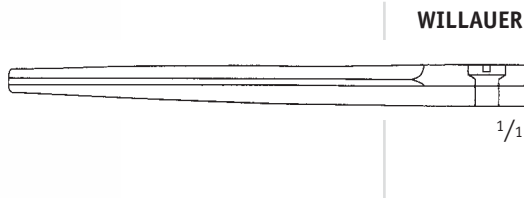

WILLAER

 Artikel-Nr.
 Cat. No.

02-53-710

 Gesamtlänge
 Total length

255 mm / 10"

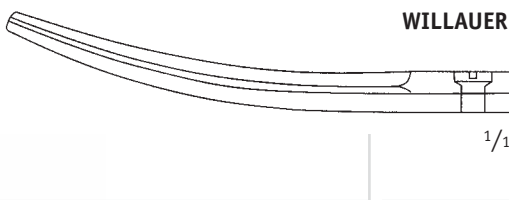

WILLAER

02-53-711

255 mm / 10"



1/2



THOREK

02-03-636

190 mm / 7 1/2"

02-53-712

250 mm / 10"

Artikel-Nr.
Cat. No.

Gesamtlänge
Total length

02-53-713

300 mm / 12"

CRAFOORD

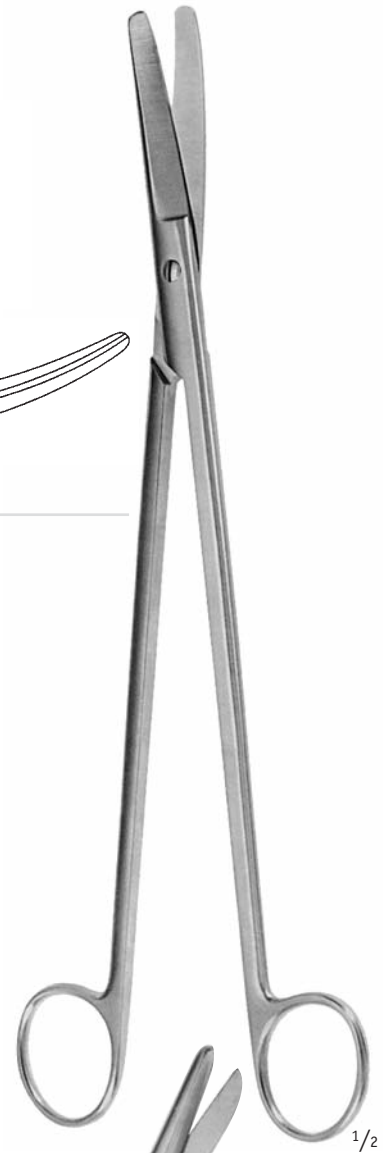

05-20-141

200 mm / 8"

Sternumschere
Sternum scissors · Ciseaux à sternum
Tijera de esternón · Forbici per sterno

**BRAUN-
STADLER**

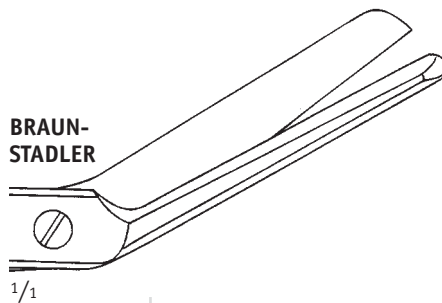

JORGENSEN

 Artikel-Nr.
 Cat. No.

02-53-714

 Gesamtlänge
 Total length

 220 mm / 8³/₄"

02-53-715

280 mm / 11"

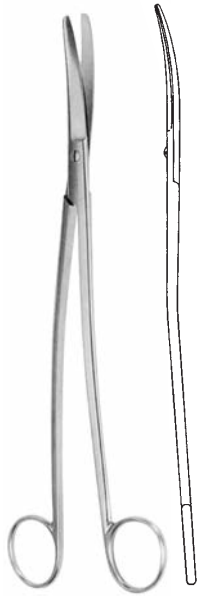

1/3

**KLINKEN-
BERGH-
LOTH**
02-03-640

230 mm / 9"

1/1

1/3

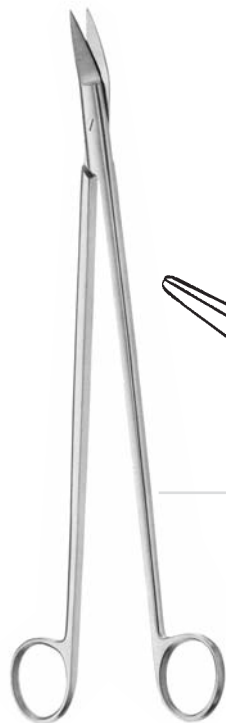
FINOCHIETTO
02-53-716

 270 mm / 10³/₄"

 Lungenlappenschere
 Lobectomy scissors · Ciseaux à lobectomie
 Tijeras para lobectomía · Forbici per lobo polmonare

1/1

1/3

Artikel-Nr. Cat. No.	Gesamtlänge Total length	SPENCER		1/1		1/2
02-03-801	90 mm / 3 1/2"	SPENCER		1/1		1/2
02-03-802	110 mm / 4 1/4"	SPENCER		1/1		1/2
02-53-800	120 mm / 4 3/4"	SPENCER		1/1		1/2
02-03-803	140 mm / 5 1/2"	LITTAUER		1/1		1/2



2/3

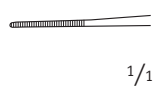

1/1

 Artikel-Nr.
 Cat. No.

15-03-020

 Gesamtlänge
 Total length

100 mm / 4"

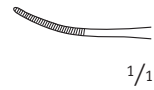

1/1

15-03-021

100 mm / 4"

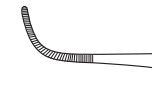

1/1

15-03-022

100 mm / 4"



2/3

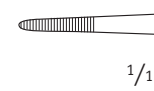

1/1

02-04-210

115 mm / 4 1/2"

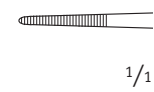

1/1

SEMKEN

02-04-215

125 mm / 5"

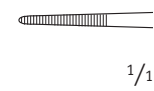

1/1

SEMKEN

02-04-215T

125 mm / 5"

 Titan
 Titanium · Titane · Titanio · Titanio

1/1

SEMKEN

02-04-668

125 mm / 5"

02-04-669

145 mm / 5 3/4"

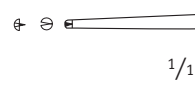

1/1

SEMKEN

02-04-665

125 mm / 5"

02-04-667

150 mm / 6"











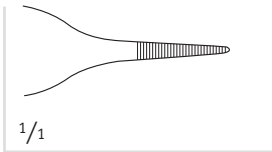

1/1

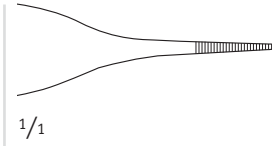
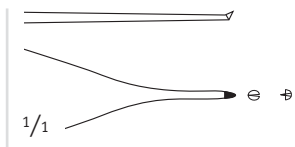

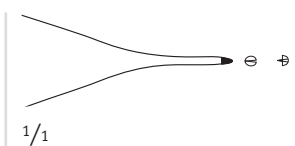
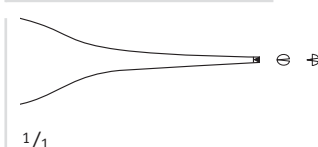
SEMKEN

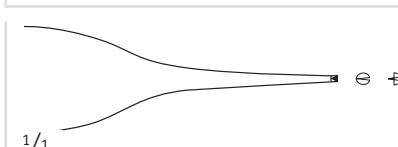
02-04-666

125 mm / 5"

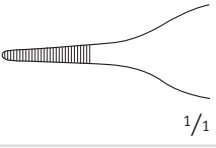
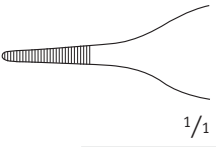
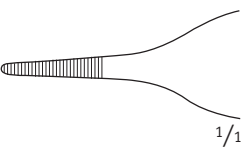
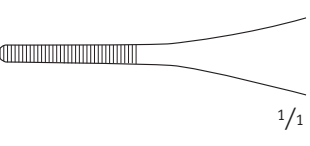
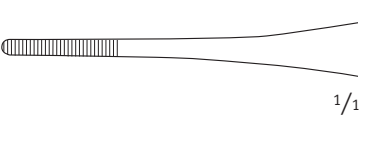

Artikel-Nr. Cat. No.	Gesamtlänge Total length				
02-04-220	120 mm / 4 ³ / ₄ "	MICRO-ADSON		1/1	
02-04-223	150 mm / 6"	MICRO-ADSON		1/1	
02-04-509	120 mm / 4 ³ / ₄ "	MICRO-ADSON BIEMER		1/1	
02-04-510	120 mm / 4 ³ / ₄ "	MICRO-ADSON BIEMER		1/1	
02-04-520	150 mm / 6"	MICRO-ADSON		1/1	
02-54-521	180 mm / 7"	MICRO-ADSON		1/1	
02-54-522	120 mm / 4 ³ / ₄ "	MICRO-ADSON		1/1	
02-54-523	150 mm / 6"	MICRO-ADSON		1/1	
TC					

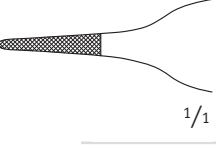
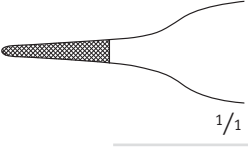
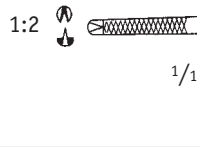
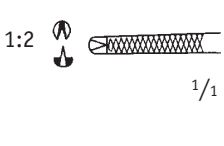
		Artikel-Nr. Cat. No.	Gesamtlänge Total length
 $\frac{2}{3}$	 $\frac{1}{1}$	ADSON 02-04-222	120 mm / 4 $\frac{3}{4}$ "
	 $\frac{1}{1}$	ADSON 02-04-222T	120 mm / 4 $\frac{3}{4}$ " Titan Titanium · Titane · Titanio · Titanio
	 $\frac{1}{1}$	ADSON 02-54-223	150 mm / 6"
	 $\frac{1}{1}$	ADSON 02-04-224	180 mm / 7"
	 $\frac{1}{1}$	JEFFERSON 02-04-226	180 mm / 7"
 $\frac{2}{3}$	 $\frac{1}{1}$	ADSON 02-04-151	120 mm / 4 $\frac{3}{4}$ "
	 $\frac{1}{1}$	ADSON 02-54-152	150 mm / 6"
	 $\frac{1}{1}$	ADSON 02-54-153	120 mm / 4 $\frac{3}{4}$ "
	 $\frac{1}{1}$	ADSON 02-54-154	150 mm / 6"
			TC

Artikel-Nr. Cat. No.	Gesamtlänge Total length			
02-04-511	120 mm / 4 ³ / ₄ "	ADSON		
02-04-512 02-54-513	120 mm / 4 ³ / ₄ " 150 mm / 6"	ADSON		
02-04-522	180 mm / 7"	ADSON		
02-04-523	180 mm / 7"	JEFFERSON		
02-04-506	120 mm / 4 ³ / ₄ "	ADSON		
02-04-508	120 mm / 4 ³ / ₄ "	ADSON		
02-04-507	120 mm / 4 ³ / ₄ "	ADSON		
02-04-513	120 mm / 4 ³ / ₄ "	ADSON		
02-04-521	150 mm / 6"	ADSON		

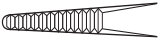
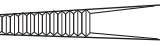
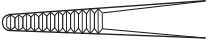
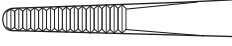
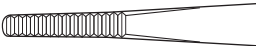
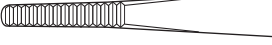
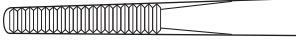
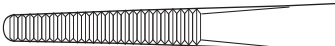

		Artikel-Nr. Cat. No.	Gesamtlänge Total length
	STANDARD	02-04-043	115 mm / 4 ¹ / ₂ "
	STANDARD	02-04-045	130 mm / 5 ¹ / ₈ "
	STANDARD	02-04-047	145 mm / 5 ³ / ₄ "
	STANDARD	02-04-049	160 mm / 6 ¹ / ₄ "
	STANDARD	02-04-050	180 mm / 7"
	STANDARD	02-04-051	200 mm / 8"
	STANDARD	02-04-052	250 mm / 10"
	STANDARD	02-04-053	300 mm / 12"

1/1

1/1

1/1

1/1







1/1

1/1

1/1

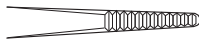
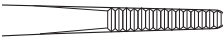
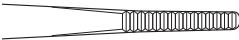
1/1

1/1









Artikel-Nr. Cat. No.	Gesamtlänge Total length		
02-04-023	115 mm / 4 ¹ / ₂ "	schmal narrow · étroite · estrecha · stretta	 1/1
02-04-025	130 mm / 5 ¹ / ₈ "	schmal narrow · étroite · estrecha · stretta	 1/1
02-04-027	145 mm / 5 ³ / ₄ "	schmal narrow · étroite · estrecha · stretta	 1/1
02-04-029	160 mm / 6 ¹ / ₄ "	schmal narrow · étroite · estrecha · stretta	 1/1
02-04-030	180 mm / 7"	schmal narrow · étroite · estrecha · stretta	 1/1
02-04-031	200 mm / 8"	schmal narrow · étroite · estrecha · stretta	 1/1
02-04-032	250 mm / 10"	schmal narrow · étroite · estrecha · stretta	 1/1
02-04-033	300 mm / 12"	schmal narrow · étroite · estrecha · stretta	 1/1





1/1

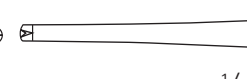

1/1

		Artikel-Nr. Cat. No.	Gesamtlänge Total length
	STANDARD	02-04-553	115 mm / 4 ¹ / ₂ "
	STANDARD	02-04-555	130 mm / 5 ¹ / ₈ "
	STANDARD	02-04-557	145 mm / 5 ³ / ₄ "
	STANDARD	02-04-559	160 mm / 6 ¹ / ₄ "
	STANDARD	02-04-560	180 mm / 7"
	STANDARD	02-04-561	200 mm / 8"
	STANDARD	02-54-561	230 mm / 8"
	STANDARD	02-04-562	250 mm / 10"
	STANDARD	02-04-563	300 mm / 12"

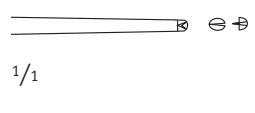
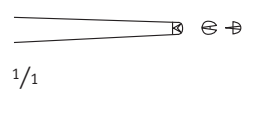
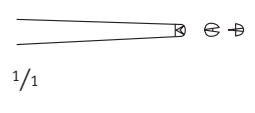
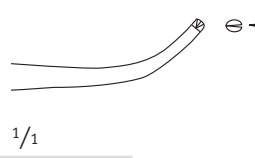
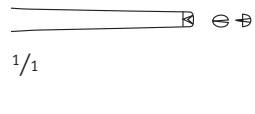
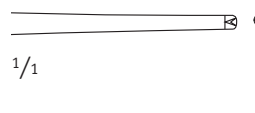

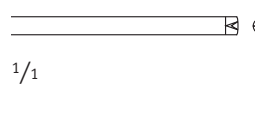
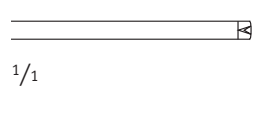
Artikel-Nr. Cat. No.	Gesamtlänge Total length		
02-04-533	115 mm / 4 ¹ / ₂ "	schmal narrow · étroite · estrecha · stretta	
02-04-535	130 mm / 5 ¹ / ₈ "	schmal narrow · étroite · estrecha · stretta	
02-04-537	145 mm / 5 ³ / ₄ "	schmal narrow · étroite · estrecha · stretta	
02-04-527	145 mm / 5 ³ / ₄ "	schmal narrow · étroite · estrecha · stretta	
02-04-539	160 mm / 6 ¹ / ₄ "	schmal narrow · étroite · estrecha · stretta	
02-04-540	180 mm / 7"	schmal narrow · étroite · estrecha · stretta	
02-04-541	200 mm / 8"	schmal narrow · étroite · estrecha · stretta	
02-04-542	250 mm / 10"	schmal narrow · étroite · estrecha · stretta	
02-04-543	300 mm / 12"	schmal narrow · étroite · estrecha · stretta	











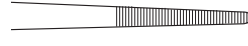

1/1



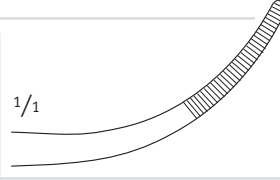



1/1

		Artikel-Nr. Cat. No.	Gesamtlänge Total length
		02-04-154	145 mm / 5 ³ / ₄ "
		02-54-155	160 mm / 6 ¹ / ₄ "
		02-04-156	180 mm / 7"
		02-04-157	200 mm / 8"
		02-04-158	230 mm / 9"
		02-04-159	250 mm / 10"
		TC	
	STANDARD	02-04-164	145 mm / 5 ³ / ₄ "
	STANDARD	02-04-165	200 mm / 8"
	STANDARD	02-04-166	250 mm / 10"

Artikel-Nr. Cat. No.	Gesamtlänge Total length			
02-04-238	180 mm / 7"	CUSHING	 1/1	 1/2
02-04-239	200 mm / 8"	CUSHING	 1/1	
02-04-243	200 mm / 8"	CUSHING	 1/1	
02-04-240	250 mm / 10"	CUSHING	 1/1	
02-04-246	200 mm / 8"	BROPHY	 1/1	 1/2
02-04-247	200 mm / 8"	BROPHY	 1/1	
02-54-248	300 mm / 8"	BROPHY	 1/1	
02-04-231	185 mm / 7 1/4"		 1/1	
02-04-232	200 mm / 8"		 1/1	
02-04-257	200 mm / 8"		 1/1	



1/1

	Artikel-Nr. Cat. No.	Gesamtlänge Total length
 1/1	02-54-574	115 mm / 4 ¹ / ₂ "
 1/1	02-04-575	130 mm / 5"
 1/1	02-04-577	145 mm / 5 ³ / ₄ "
 1/1	02-04-579	160 mm / 6 ¹ / ₄ "
 1/1	02-04-580	180 mm / 7"
 1/1	02-04-581	200 mm / 8"
 1/1	02-54-582	250 mm / 10"

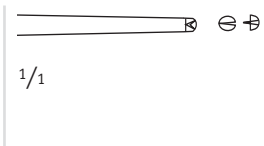
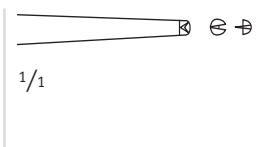
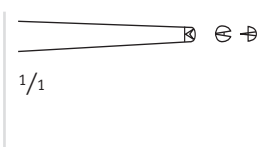
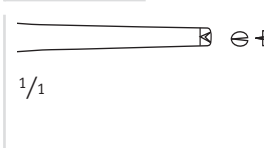
Artikel-Nr. Cat. No.	Gesamtlänge Total length		
02-54-600	180 mm / 7"	POTTS-SMITH	 1/1
02-54-601	210 mm / 8 ¹ / ₄ "	POTTS-SMITH	 1/1
02-54-602	250 mm / 10"	POTTS-SMITH	 1/1
02-54-603	400 mm / 16"	POTTS-SMITH	 1/1







1/1













		Artikel-Nr. Cat. No.	Gesamtlänge Total length
	MC INDOE	02-04-236	150 mm / 6"
	MC INDOE	02-54-237 TC	150 mm / 6"
	MC INDOE	02-04-236T	150 mm / 6" Titan Titanium · Titane · Titanio · Titanio
	MC INDOE	02-04-661	150 mm / 6"



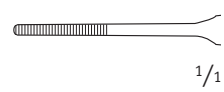
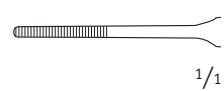
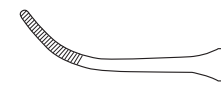
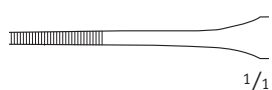

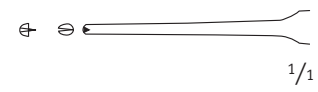
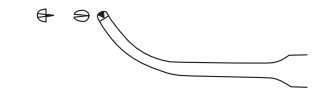
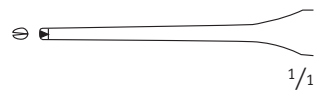

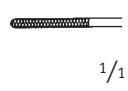









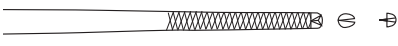

	GILLIES	02-04-213	150 mm / 6"
	GILLIES	02-04-660	150 mm / 6"
	GILLIES	02-54-661	150 mm / 6"
		TC	

Artikel-Nr. Cat. No.	Gesamtlänge Total length			
02-04-268	175 mm / 7"	CAIRNS-DOTT	 1/1	 1/2
02-54-269	170 mm / 6 ³ / ₄ "	CUSHING	 1/1	
02-04-269	215 mm / 8 ¹ / ₂ "	CAIRNS-DOTT	 1/1	

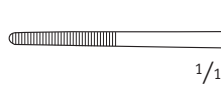
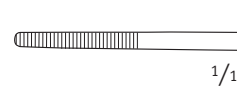
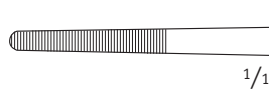
02-04-160	180 mm / 7"	CUSHING	 1/1	 1/2
02-54-161	170 mm / 6 ³ / ₄ "	CUSHING	 1/1	
02-54-162	170 mm / 6 ³ / ₄ "	CUSHING	 1/1	
TC				

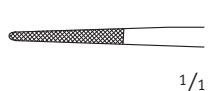
 <p>1/2</p>	 <p>1/1</p>	GERALD	02-04-228	175 mm / 7"
	 <p>1/1</p>	GERALD	02-04-228T	175 mm / 7" Titan Titanium · Titane · Titanio · Titanio
	 <p>1/1</p>	GERALD	02-04-229	175 mm / 7"
	 <p>1/1</p>	GERALD	02-04-230	230 mm / 9"
 <p>1/2</p>	 <p>1/1</p>	GERALD	02-04-662	175 mm / 7"
	 <p>1/1</p>	GERALD	02-04-663	175 mm / 7"
	 <p>1/1</p>	GERALD	02-04-664	230 mm / 9"
 <p>1/2</p>	 <p>1/1</p>	GERALD	02-54-665	175 mm / 7"
	 <p>1/1</p>	GERALD	02-54-666	175 mm / 7"
	TC			

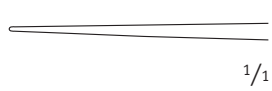
Artikel-Nr. Cat. No.	Gesamtlänge Total length	WAUGH		
02-54-668	150 mm / 5"	WAUGH		
			1/1	
02-54-669	200 mm / 8"	WAUGH		
			1/1	
02-04-670	180 mm / 7"	WAUGH		
			1/1	
02-04-671	200 mm / 8"	WAUGH		
			1/1	
02-04-672	250 mm / 10"	WAUGH		
			1/1	
02-04-679	305 mm / 12"	WAUGH		
			1/1	

		Artikel-Nr. Cat. No.	Gesamtlänge Total length
 <p>1/2</p>	 <p>1/1</p>	LUCAE 02-04-878	140 mm / 5 1/2"
	 <p>1/1</p>	JANSEN 02-04-880	160 mm / 6 1/4"
	 <p>1/1</p>	ADSON 02-04-870	175 mm / 7"
 <p>1/2</p>	 <p>1/1</p>	GRUENWALD 02-04-168	185 mm / 7 1/4"
	 <p>1/1</p>	GRUENWALD 02-04-883	200 mm / 8"
 <p>1/2</p>	 <p>1/1</p>	02-04-885	185 mm / 7 1/4"
	 <p>1/1</p>	LUCAE 02-04-879	140 mm / 5 1/2"
	 <p>1/1</p>	02-04-886	200 mm / 8"

TC

Artikel-Nr.
 Cat. No.

Gesamtlänge
 Total length

02-54-800

155 mm / 6"

NELSON

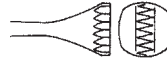

1/1

02-54-801

180 mm / 7"

02-04-802

230 mm / 9"

02-54-803

300 mm / 12"



1/2

02-04-171

155 mm / 6"

WANGEN-
 STEEN



1/1

02-04-173

230 mm / 9"

02-54-174

250 mm / 10"

TC



1/2



 Russ.
Mod.

 Artikel-Nr.
Cat. No.

 Gesamtlänge
Total length

02-04-755

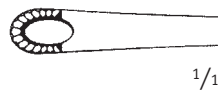
150 mm / 6"

 Russ.
Mod.

02-04-760

200 mm / 8"

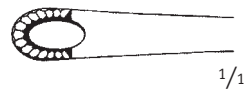
 Russ.
Mod.

02-54-761

250 mm / 10"

1/2



SELMAN

02-54-770

150 mm / 5"





02-54-771



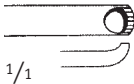

200 mm / 8"

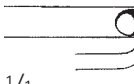
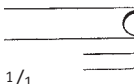
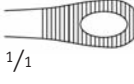

02-54-772



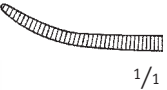

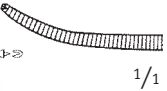

250 mm / 10"

1/2



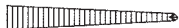
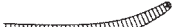
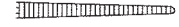





Artikel-Nr. Cat. No.	Gesamtlänge Total length			
02-54-775	140 mm / 5 ³ / ₄ "	DURANTE		
02-54-776	160 mm / 6 ¹ / ₄ "	DURANTE		
02-54-777	200 mm / 8"	DURANTE		
02-54-799 02-04-801	180 mm / 7" 230 mm / 9"	SINGLEY-TUTTLE		

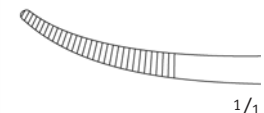

		Artikel-Nr. Cat. No.	Gesamtlänge Total length
		BABY-MOSQUITO 02-08-104	100 mm / 4"
		BABY-MOSQUITO 02-08-105	100 mm / 4"
		BABY-MOSQUITO 02-08-114	100 mm / 4"
		BABY-MOSQUITO 02-08-115	100 mm / 4"

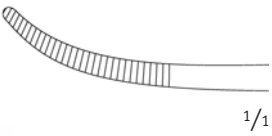

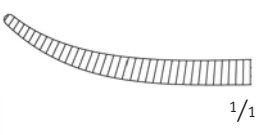
		02-58-090	120 mm / 4 ³ / ₄ " Fadenklemme, Maul kreuzgerieft <i>Ligature Forceps, cross serrations</i> <i>Pince à ligatures, mors à rainures croisées</i> <i>Pinza para hilos, bocas con estrias cruzadas</i> <i>Pinza per legature, morso con striatura cruciforme</i>
---	---	------------------	---

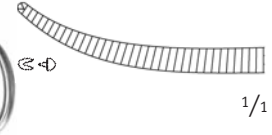
Artikel-Nr. Cat. No.		Gesamtlänge Total length		
02-08-110	02-08-110T	125 mm / 5"	HALSTEAD-MOSQUITO	 1/1
02-08-140	Titan	140 mm / 5 ¹ / ₂ "		
02-08-202	Titanium	180 mm / 7"		
02-08-210	Titane	210 mm / 8 ¹ / ₄ "		
	Titano			
	Titano			
02-08-111	02-08-111T	125 mm / 5"	HALSTEAD-MOSQUITO	 1/1
02-08-141	Titan	140 mm / 5 ¹ / ₂ "		
02-08-203	Titanium	180 mm / 7"		
02-08-211	Titane	210 mm / 8 ¹ / ₄ "		
	Titano			
	Titano			
02-08-120	02-08-120T	125 mm / 5"	HALSTEAD-MOSQUITO	 1/1
02-08-150	Titan	140 mm / 5 ¹ / ₂ "		
02-08-212	Titanium	180 mm / 7"		
02-08-214	Titane	210 mm / 8 ¹ / ₄ "		
	Titano			
	Titano			
02-08-121	02-08-121T	125 mm / 5"	HALSTEAD-MOSQUITO	 1/1
02-08-151	Titan	140 mm / 5 ¹ / ₂ "		
02-08-213	Titanium	180 mm / 7"		
02-08-215	Titane	210 mm / 8 ¹ / ₄ "		
	Titano			
	Titano			
02-58-106		100 mm / 4"	HALSTEAD-MOSQUITO micro	 1/1
02-08-108		125 mm / 5"		
02-58-107		100 mm / 4"	HALSTEAD-MOSQUITO micro	 1/1
02-08-109		125 mm / 5"		
02-58-116		100 mm / 4"	HALSTEAD-MOSQUITO micro	 1/1
02-08-118		125 mm / 5"		
02-58-117		100 mm / 4"	HALSTEAD-MOSQUITO micro	 1/1
02-08-119		125 mm / 5"		

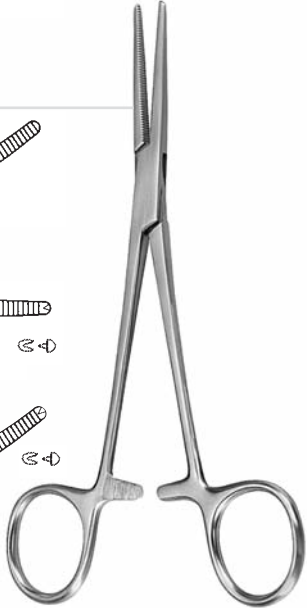
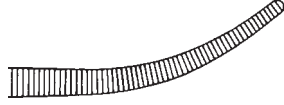

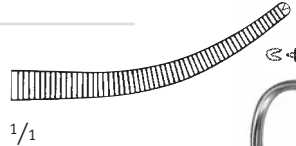
		Artikel-Nr. Cat. No.	Gesamtlänge Total length
 1/2	 1/1	KELLY 02-08-134 02-08-134T Titan Titanium · Titane Titanio · Titanio	140 mm / 5 1/2"
	 1/1	KELLY 02-08-135 02-08-135T Titan Titanium · Titane Titanio · Titanio	140 mm / 5 1/2"
 1/2	 1/1	RANKIN 02-08-164	160 mm / 6 1/4"
	 1/1	RANKIN 02-08-165	160 mm / 6 1/4"
 1/2	 1/1	CRILE 02-08-144 02-08-144T Titan Titanium · Titane Titanio · Titanio	140 mm / 5 1/2"
	 1/1	CRILE 02-08-145 02-08-145T Titan Titanium · Titane Titanio · Titanio	140 mm / 5 1/2"
 1/2	 1/1	CRILE 02-08-154	140 mm / 5 1/2"
	 1/1	CRILE 02-08-155	140 mm / 5 1/2"

Artikel-Nr. Cat. No.	Gesamtlänge Total length			
02-08-166	160 mm / 6 ¹ / ₄ "	CRILE	 1/1	 1/2
02-08-167	160 mm / 6 ¹ / ₄ "	CRILE	 1/1	
02-08-176	160 mm / 6 ¹ / ₄ "	CRILE	 1/1	
02-08-177	160 mm / 6 ¹ / ₄ "	CRILE	 1/1	

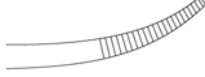
02-08-130	140 mm / 5 ¹ / ₂ "	PROVIDENCE-HOSPITAL	 1/1	 1/2
02-08-131	140 mm / 5 ¹ / ₂ "	PROVIDENCE-HOSPITAL	 1/1	

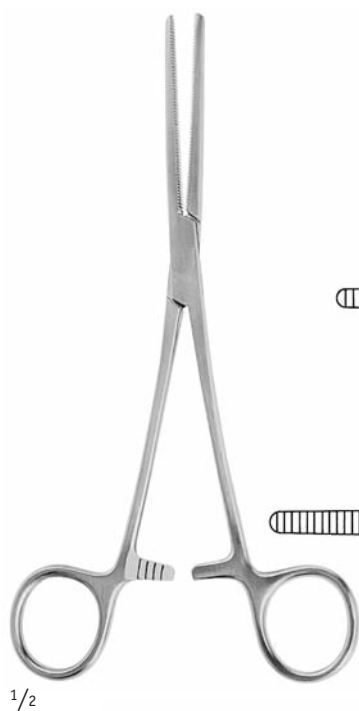

1/2

**ROCHESTER-
PEAN**

 Artikel-Nr.
Cat. No.

 Gesamtlänge
Total length

02-08-424

140 mm / 5¹/₂"

1/1

**ROCHESTER-
PEAN**

02-08-442

160 mm / 6¹/₄"

1/1

**ROCHESTER-
PEAN**

02-08-444

180 mm / 7"



1/1

**ROCHESTER-
PEAN**

02-08-446

200 mm / 8"



1/1

**ROCHESTER-
PEAN**

02-08-448

220 mm / 8³/₄"

1/1

**ROCHESTER-
PEAN**

02-08-450

240 mm / 9¹/₂"

1/1

**ROCHESTER-
PEAN**

02-08-472

260 mm / 10¹/₄"

1/1





**ROCHESTER-
PEAN**

02-08-474

300 mm / 12"



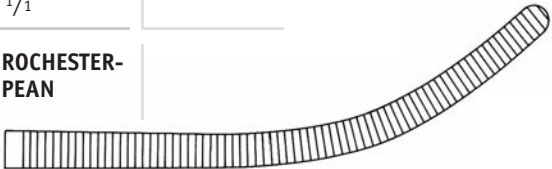
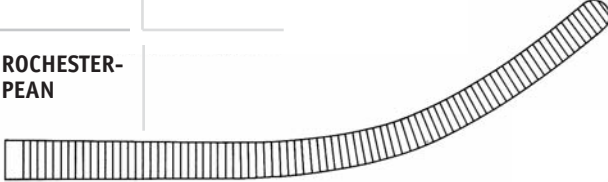
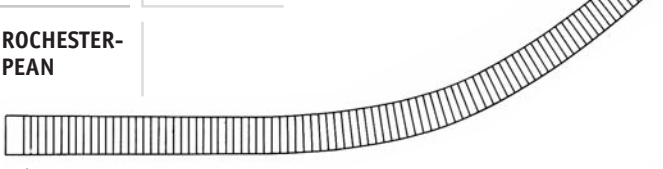
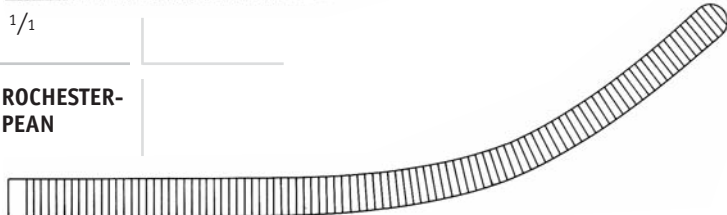

1/1



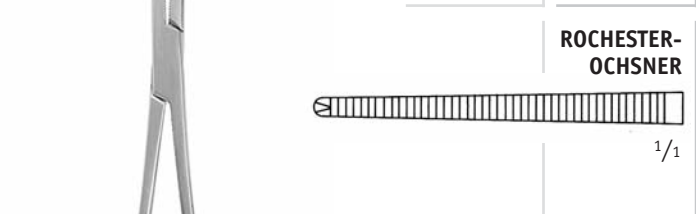
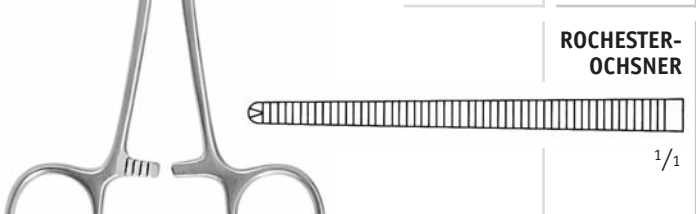
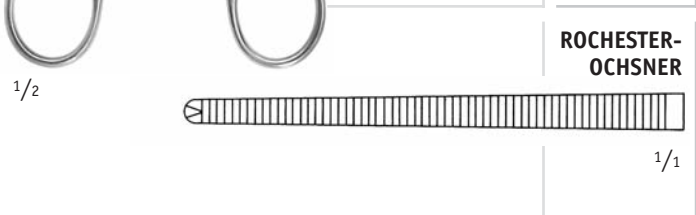
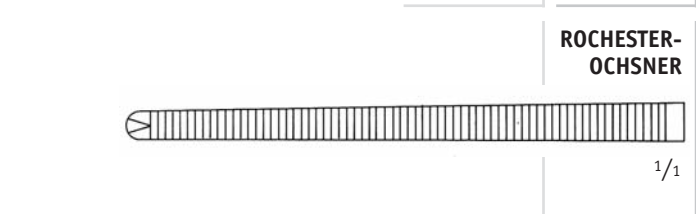
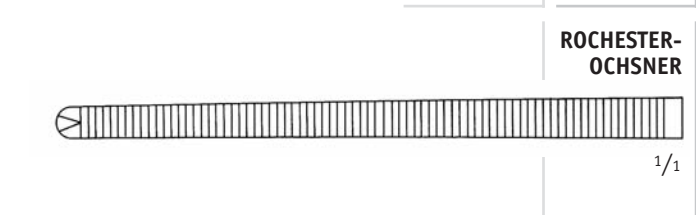
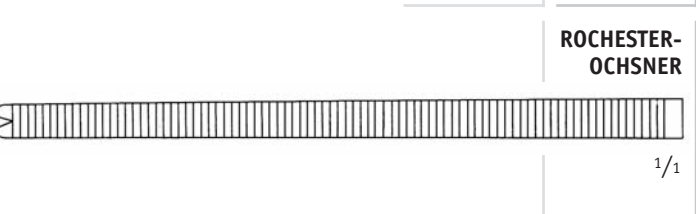
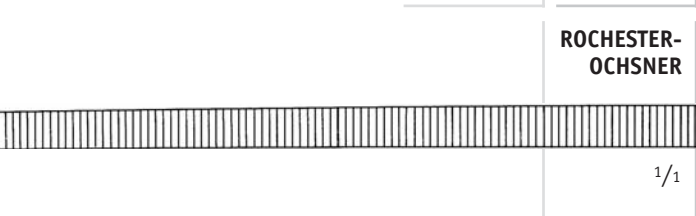



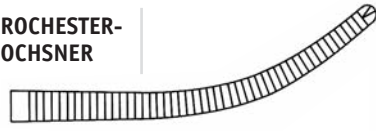
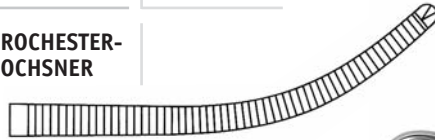
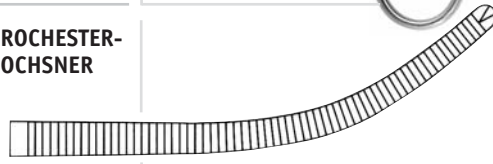
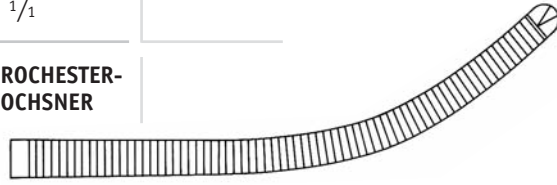
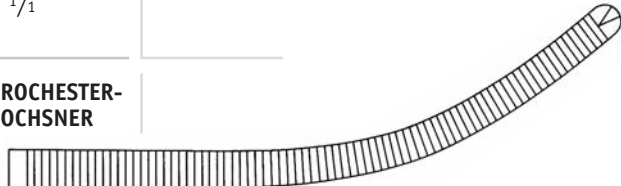
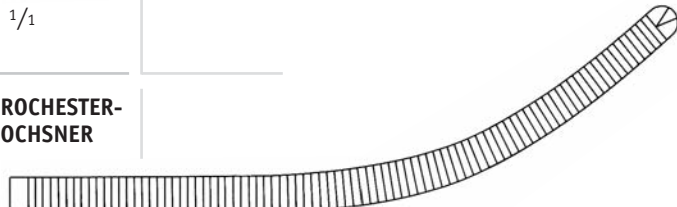
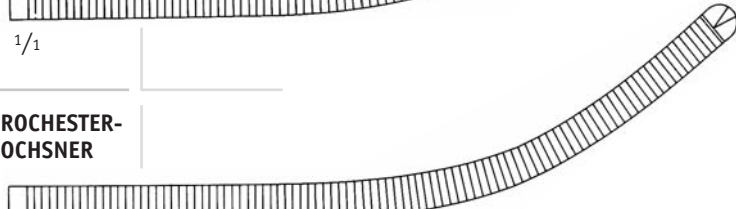

Artikel-Nr. Cat. No.	Gesamtlänge Total length	
02-08-425	140 mm / 5½"	<p>ROCHESTER-PEAN</p>  <p>1/1</p>
02-08-443	160 mm / 6¼"	<p>ROCHESTER-PEAN</p>  <p>1/1</p>
02-08-445	180 mm / 7"	<p>ROCHESTER-PEAN</p>  <p>1/1</p>
02-08-447	200 mm / 8"	<p>ROCHESTER-PEAN</p>  <p>1/1</p>
02-08-449	220 mm / 8¾"	<p>ROCHESTER-PEAN</p>  <p>1/1</p>
02-08-451	240 mm / 9½"	<p>ROCHESTER-PEAN</p>  <p>1/1</p>
02-08-473	260 mm / 10¼"	<p>ROCHESTER-PEAN</p>  <p>1/1</p>
02-08-475	300 mm / 12"	<p>ROCHESTER-PEAN</p>  <p>1/1</p>



	Artikel-Nr. Cat. No.	Gesamtlänge Total length
	ROCHESTER- OCHSNER 02-08-618	140 mm / 5 ¹ / ₂ "
	ROCHESTER- OCHSNER 02-08-642	160 mm / 6 ¹ / ₄ "
	ROCHESTER- OCHSNER 02-08-644	180 mm / 7"
	ROCHESTER- OCHSNER 02-08-646	200 mm / 8"
	ROCHESTER- OCHSNER 02-08-648	220 mm / 8 ³ / ₄ "
	ROCHESTER- OCHSNER 02-08-650	240 mm / 9 ¹ / ₂ "
	ROCHESTER- OCHSNER 02-08-652	260 mm / 10 ¹ / ₄ "
	ROCHESTER- OCHSNER 02-08-654	300 mm / 12"

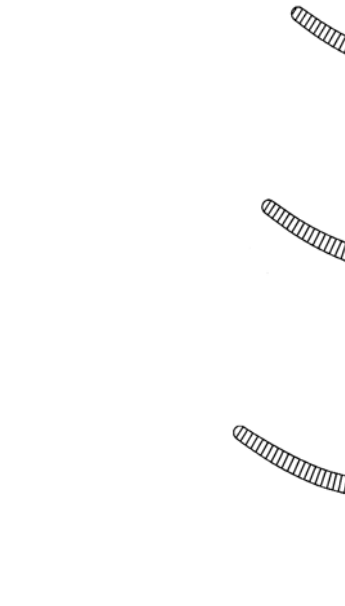





Artikel-Nr. Cat. No.	Gesamtlänge Total length	
02-08-619	140 mm / 5½"	<p>ROCHESTER-OCHSNER</p>  <p>1/1</p>
02-08-643	160 mm / 6¼"	<p>ROCHESTER-OCHSNER</p>  <p>1/1</p>
02-08-645	180 mm / 7"	<p>ROCHESTER-OCHSNER</p>  <p>1/1</p>
02-08-647	200 mm / 8"	<p>ROCHESTER-OCHSNER</p>  <p>1/1</p>
02-08-649	220 mm / 8¾"	<p>ROCHESTER-OCHSNER</p>  <p>1/1</p>
02-08-651	240 mm / 9½"	<p>ROCHESTER-OCHSNER</p>  <p>1/1</p>
02-08-653	260 mm / 10¼"	<p>ROCHESTER-OCHSNER</p>  <p>1/1</p>
02-08-655	300 mm / 12"	<p>ROCHESTER-OCHSNER</p>  <p>1/1</p>



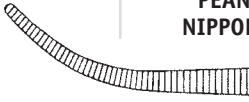

		Artikel-Nr. Cat. No.	Gesamtlänge Total length
 1/2	 1/1	PEAN 02-08-412	130 mm / 5" Graziles Modell Delicate Pattern · Modèle gracile Modelo delicado · Modello delicato
	 1/1	PEAN 02-08-414	140 mm / 5 1/2" Graziles Modell Delicate Pattern · Modèle gracile Modelo delicado · Modello delicato
	 1/1	PEAN 02-58-416	160 mm / 6 1/4" Graziles Modell Delicate Pattern · Modèle gracile Modelo delicado · Modello delicato
 1/2	 1/1	PEAN 02-08-413	130 mm / 5" Graziles Modell Delicate Pattern · Modèle gracile Modelo delicado · Modello delicato
	 1/1	PEAN 02-08-415	140 mm / 5 1/2" Graziles Modell Delicate Pattern · Modèle gracile Modelo delicado · Modello delicato
	 1/1	PEAN 02-58-417	160 mm / 6 1/4" Graziles Modell Delicate Pattern · Modèle gracile Modelo delicado · Modello delicato

Artikel-Nr. Cat. No.	Gesamtlänge Total length		
02-08-612	130 mm / 5"	KOCHER	 1/1
	Graziles Modell Delicate Pattern · Modèle gracile Modelo delicado · Modello delicato		
02-08-614	140 mm / 5½"	KOCHER	 1/1
	Graziles Modell Delicate Pattern · Modèle gracile Modelo delicado · Modello delicato		
02-58-616	160 mm / 6¼"	KOCHER	 1/1
	Graziles Modell Delicate Pattern · Modèle gracile Modelo delicado · Modello delicato		
02-58-613	130 mm / 5"	KOCHER	 1/1
	Graziles Modell Delicate Pattern · Modèle gracile Modelo delicado · Modello delicato		
02-08-615	140 mm / 5½"	KOCHER	 1/1
	Graziles Modell Delicate Pattern · Modèle gracile Modelo delicado · Modello delicato		
02-58-617	160 mm / 6¼"	KOCHER	 1/1
	Graziles Modell Delicate Pattern · Modèle gracile Modelo delicado · Modello delicato		

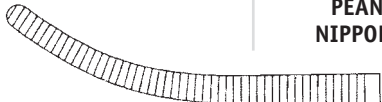

		Artikel-Nr. Cat. No.	Gesamtlänge Total length
	 <p>PEAN-NIPPON 1/1</p>	02-58-400	140 mm / 5½"
	 <p>PEAN-NIPPON 1/1</p>	02-58-402	160 mm / 6¼"
	 <p>PEAN-NIPPON 1/1</p>	02-58-404	180 mm / 7"
 <p>1/2</p>	 <p>PEAN-NIPPON 1/1</p>	02-58-401	140 mm / 5½"
	 <p>PEAN-NIPPON 1/1</p>	02-58-403	160 mm / 6¼"
	 <p>PEAN-NIPPON 1/1</p>	02-58-405	180 mm / 7"











Artikel-Nr. Cat. No.	Gesamtlänge Total length		
02-58-406	140 mm / 5½"	KOCHER-NIPPON	 1/1
02-58-408	160 mm / 6¼"	KOCHER-NIPPON	 1/1
02-58-410	180 mm / 7"	KOCHER-NIPPON	 1/1
02-58-407	140 mm / 5½"	KOCHER-NIPPON	 1/1
02-58-409	160 mm / 6¼"	KOCHER-NIPPON	 1/1
02-58-411	180 mm / 7"	KOCHER-NIPPON	 1/1













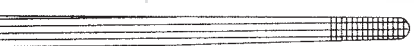



1/2







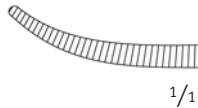

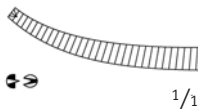

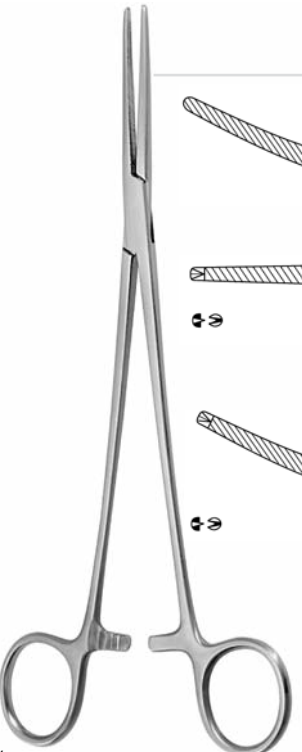

1/2

	Artikel-Nr. Cat. No.	Gesamtlänge Total length
 SPENCER- WELLS 1/1	02-08-332	130 mm / 5"
 SPENCER- WELLS 1/1	02-58-330	140 mm / 5½"
 SPENCER- WELLS 1/1	02-08-334	150 mm / 6"
 SPENCER- WELLS 1/1	02-08-336	180 mm / 7"
 SPENCER- WELLS 1/1	02-08-338	200 mm / 8"
 SPENCER- WELLS 1/1	02-08-333	130 mm / 5"
 SPENCER- WELLS 1/1	02-58-331	140 mm / 5½"
 SPENCER- WELLS 1/1	02-08-335	150 mm / 6"
 SPENCER- WELLS 1/1	02-08-337	180 mm / 7"
 SPENCER- WELLS 1/1	02-08-339	200 mm / 8"

Artikel-Nr. Cat. No.	Gesamtlänge Total length			
02-08-800	160 mm / 6 ¹ / ₄ "	ROCHESTER-CARMALT	 1/1	 1/2
02-08-804	200 mm / 8"	ROCHESTER-CARMALT	 1/1	
02-08-801	160 mm / 6 ¹ / ₄ "	ROCHESTER-CARMALT	 1/1	
02-08-805	200 mm / 8"	ROCHESTER-CARMALT	 1/1	
02-08-168	160 mm / 6 ¹ / ₄ "	DIXON-LOVELACE	 1/1	 1/2
02-08-178	160 mm / 6 ¹ / ₄ "	DIXON-LOVELACE	 1/1	
02-08-139	145 mm / 5 ³ / ₄ " seitlich gebogen laterally curved · courbe latéralement curva lateralmente · curva laterale	DANDY	 1/1	 1/2
02-08-143	145 mm / 5 ³ / ₄ " seitlich gebogen laterally curved · courbe latéralement curva lateralmente · curva laterale	DANDY	 1/1	

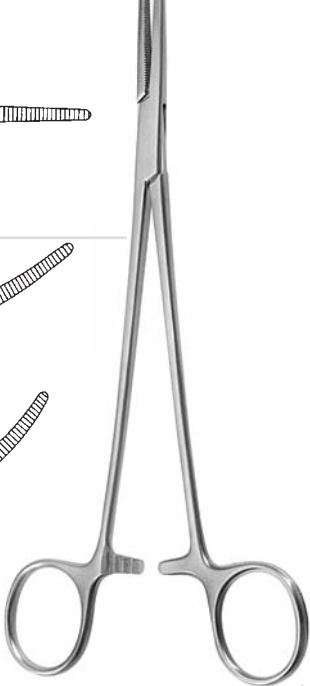
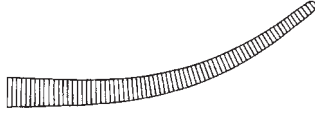
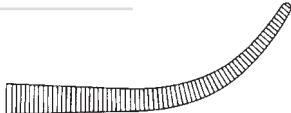
		Artikel-Nr. Cat. No.	Gesamtlänge Total length
 1/2	 1/1	LERICHE 02-08-160	150 mm / 6"
	 1/1	LERICHE 02-08-161	150 mm / 6"
	 1/1	LERICHE 02-08-170	150 mm / 6"
	 1/1	LERICHE 02-08-171	150 mm / 6"

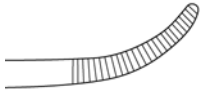
 1/2	 1/1	BENGOLEA 02-58-226	200 mm / 8"
		02-08-228	260 mm / 10 ¹ / ₄ "
	 1/1	BENGOLEA 02-58-227	200 mm / 8"
		02-08-229	260 mm / 10 ¹ / ₄ "
	 1/1	BENGOLEA 02-58-236	200 mm / 8"
		02-08-238	260 mm / 10 ¹ / ₄ "
	 1/1	BENGOLEA 02-58-237	200 mm / 8"
		02-08-239	260 mm / 10 ¹ / ₄ "

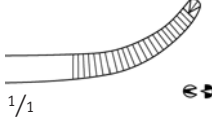
Artikel-Nr. Cat. No.	Gesamtlänge Total length			
02-08-206	200 mm / 8"	HEISS	 1/1	 1/2
02-08-207	200 mm / 8"	HEISS	 1/1	
02-08-209	200 mm / 8"	HEISS	 1/1	
02-08-200	185 mm / 7 1/4"	ADSON	 1/1	 1/2
02-08-201	185 mm / 7 1/4"	ADSON	 1/1	
02-58-202	185 mm / 7 1/4"	ADSON	 1/1	
02-58-203	185 mm / 7 1/4"	ADSON	 1/1	

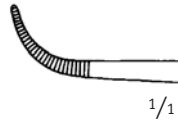
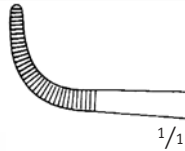
**BABY-ADSON**
 Artikel-Nr.
 Cat. No.
02-10-013
 Gesamtlänge
 Total length
140 mm / 5¹/₂"**BABY-ADSON****02-10-014**

180 mm / 7"

1/2

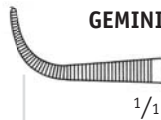
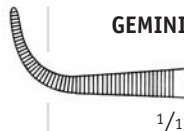
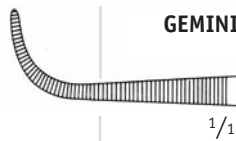
**GEMINI****02-10-100**130 mm / 5¹/₂"**GEMINI****02-60-101**160 mm / 6¹/₄"**GEMINI****02-10-102**

180 mm / 7"

**GEMINI****02-10-103**

200 mm / 8"

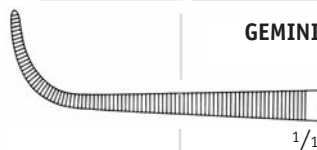
**GEMINI****02-10-104**

230 mm / 9"



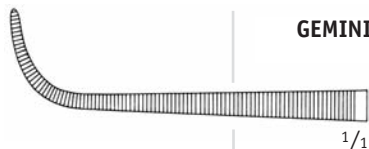



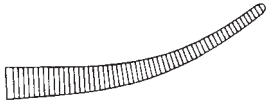

1/2

**GEMINI****02-60-105**

250 mm / 10"

**GEMINI****02-10-106**

280 mm / 11"

Artikel-Nr. Cat. No.	Gesamtlänge Total length			
02-08-198	190 mm / 7½"	FUCHSIG	 1/1	 1/2
02-60-110	180 mm / 7"	GEMINI mini	 1/1	 1/2
02-60-111	220 mm / 8¾"	GEMINI mini	 1/1	
02-60-112	250 mm / 10"	GEMINI mini	 1/1	
02-60-113	280 mm / 11"	GEMINI mini	 1/1	
02-10-009	135 mm / 5¼"	BABY-OVERHOLT	 1/1	 1/2



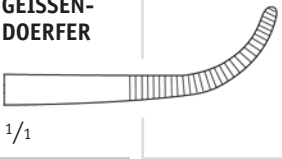
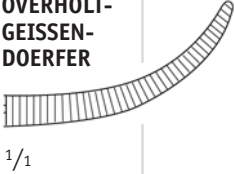
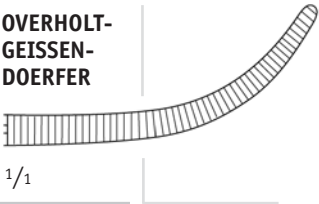
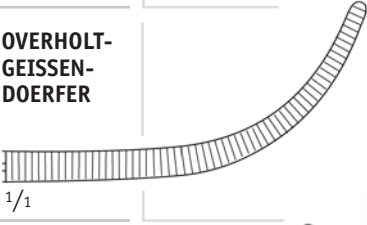
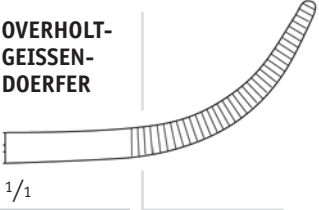
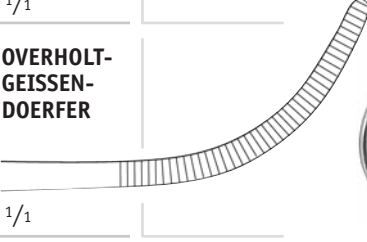
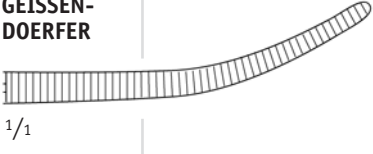

		Artikel-Nr. Cat. No.	Gesamtlänge Total length
 $\frac{1}{2}$	 OVERHOLT-GEISSEN-DOERFER $\frac{1}{1}$	02-10-020	195 mm / 7 $\frac{3}{4}$ "
	 OVERHOLT-GEISSEN-DOERFER $\frac{1}{1}$	02-10-021	210 mm / 8 $\frac{1}{4}$ "
	 OVERHOLT-GEISSEN-DOERFER $\frac{1}{1}$	02-10-022	220 mm / 8 $\frac{3}{4}$ "
	 OVERHOLT-GEISSEN-DOERFER $\frac{1}{1}$	02-10-023	225 mm / 9"
	 OVERHOLT-GEISSEN-DOERFER $\frac{1}{1}$	02-10-024	210 mm / 8 $\frac{1}{4}$ "
	 OVERHOLT-GEISSEN-DOERFER $\frac{1}{1}$	02-10-025	230 mm / 9"
	 OVERHOLT-GEISSEN-DOERFER $\frac{1}{1}$	02-10-026	225 mm / 9"



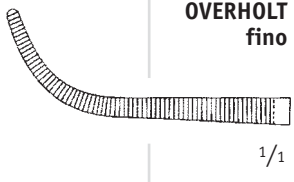
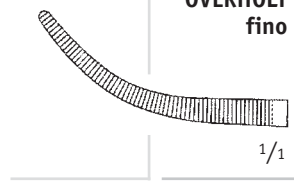
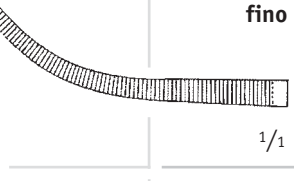
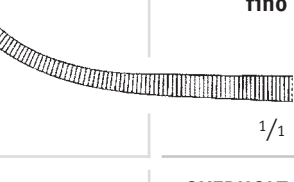

Artikel-Nr. Cat. No.	Gesamtlänge Total length		
02-60-030	270 mm / 10 ³ / ₄ "	OVERHOLT-GEISSEN-DOERFER	
02-10-031	260 mm / 10 ¹ / ₄ "	OVERHOLT-GEISSEN-DOERFER	
02-10-032	270 mm / 10 ³ / ₄ "	OVERHOLT-GEISSEN-DOERFER	
02-10-033	275 mm / 10 ³ / ₄ "	OVERHOLT-GEISSEN-DOERFER	
02-10-034	270 mm / 10 ³ / ₄ "	OVERHOLT-GEISSEN-DOERFER	
02-10-035	280 mm / 11"	OVERHOLT-GEISSEN-DOERFER	
02-60-036	270 mm / 10 ¹ / ₄ "	OVERHOLT-GEISSEN-DOERFER	

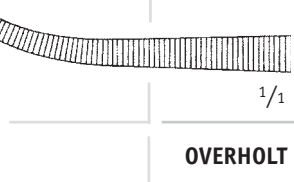



1/2

		Artikel-Nr. Cat. No.	Gesamtlänge Total length
 1/2	 OVERHOLT fino 1/1	02-10-080	215 mm / 8 ¹ / ₂ " Graziles Modell <i>Delicate Pattern · Modèle gracile</i> <i>Modelo delicado · Modello delicato</i>
	 OVERHOLT fino 1/1	02-10-081	210 mm / 8 ¹ / ₄ " Graziles Modell <i>Delicate Pattern · Modèle gracile</i> <i>Modelo delicado · Modello delicato</i>
	 OVERHOLT fino 1/1	02-10-082	220 mm / 8 ³ / ₄ " Graziles Modell <i>Delicate Pattern · Modèle gracile</i> <i>Modelo delicado · Modello delicato</i>
	 OVERHOLT fino 1/1	02-10-083	225 mm / 9" Graziles Modell <i>Delicate Pattern · Modèle gracile</i> <i>Modelo delicado · Modello delicato</i>
	 OVERHOLT fino 1/1	02-10-086	225 mm / 9" Graziles Modell <i>Delicate Pattern · Modèle gracile</i> <i>Modelo delicado · Modello delicato</i>
	 OVERHOLT 1/1	02-10-090	295 mm / 11 ³ / ₄ " Graziles Modell <i>Delicate Pattern · Modèle gracile</i> <i>Modelo delicado · Modello delicato</i>
	 OVERHOLT 1/1	02-10-091	295 mm / 11 ³ / ₄ " Graziles Modell <i>Delicate Pattern · Modèle gracile</i> <i>Modelo delicado · Modello delicato</i>
	 OVERHOLT 1/1	02-10-096	300 mm / 12" Graziles Modell <i>Delicate Pattern · Modèle gracile</i> <i>Modelo delicado · Modello delicato</i>



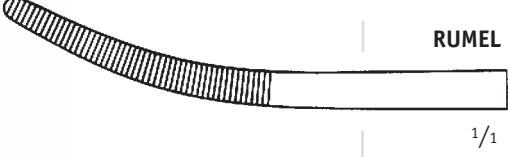
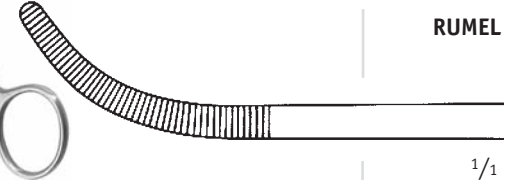
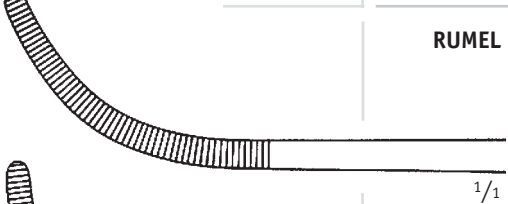
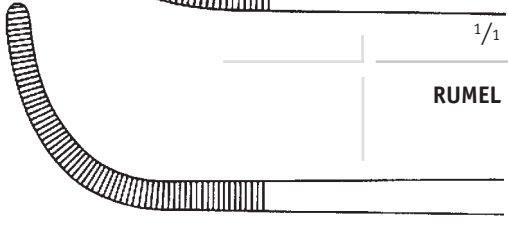
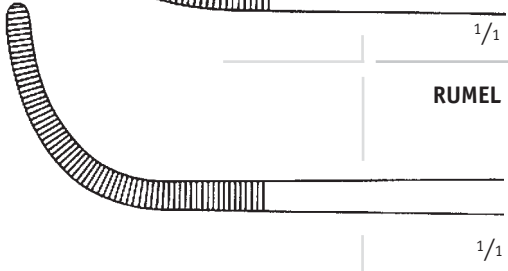

Artikel-Nr. Cat. No.	Gesamtlänge Total length	OVERHOLT	1/1	
02-10-015	185 mm / 7 ¹ / ₄ "	OVERHOLT	1/1	
02-10-016	205 mm / 8"	OVERHOLT	1/1	
02-10-017	210 mm / 8 ¹ / ₄ "	OVERHOLT	1/1	
02-10-018	215 mm / 8 ¹ / ₂ "	OVERHOLT	1/1	
02-60-019	240 mm / 9 ¹ / ₂ "	OVERHOLT	1/1	
02-10-019	210 mm / 8 ¹ / ₄ "	OVERHOLT-MIXTER	1/1	

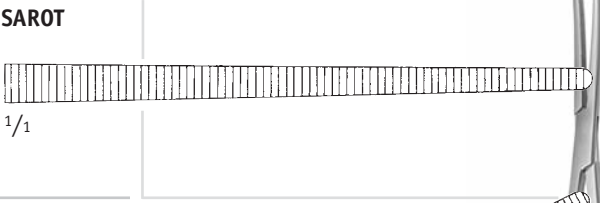
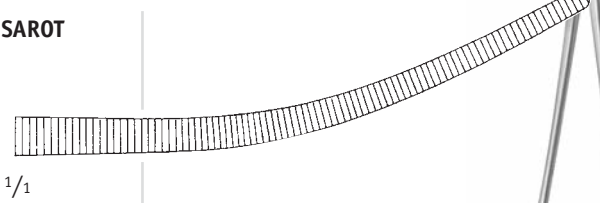
 1/3	 RUMEL 1/1	Artikel-Nr. Cat. No.	Gesamtlänge Total length
	 RUMEL 1/1	02-10-041	240 mm / 9 ¹ / ₂ "
	 RUMEL 1/1	02-10-042	240 mm / 9 ¹ / ₂ "
	 RUMEL 1/1	02-10-044	240 mm / 9 ¹ / ₂ "
	 RUMEL 1/1	02-10-045	240 mm / 9 ¹ / ₂ "
 1/3	VANDERBILT	02-60-001	215 mm / 8 ¹ / ₂ "

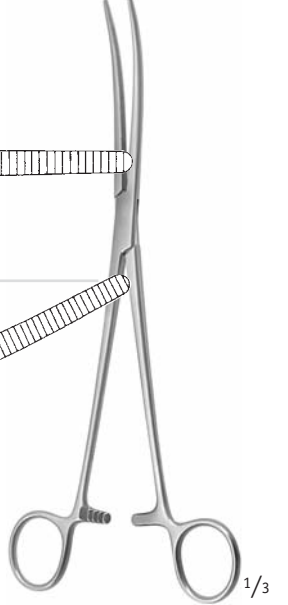
Artikel-Nr. Cat. No.	Gesamtlänge Total length		
02-08-224	240 mm / 9 ¹ / ₂ "	SAROT	
02-58-225	240 mm / 9 ¹ / ₂ "	SAROT	

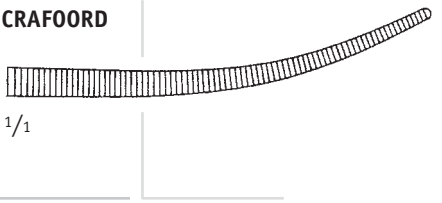
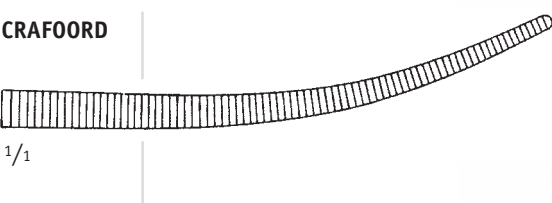

02-58-224	180 mm / 7"	CRAFOORD	
02-08-225	240 mm / 9 ¹ / ₂ "	CRAFOORD	





1/2

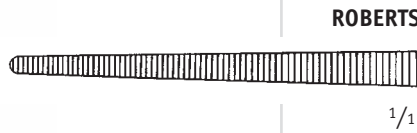

ROBERTS

1/1

 Artikel-Nr.
 Cat. No.

02-08-812

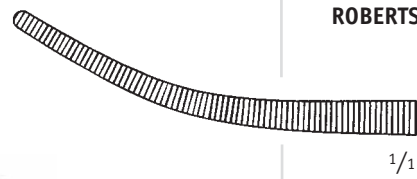
 Gesamtlänge
 Total length
220 mm / 8³/₄"

ROBERTS

1/1

02-08-813

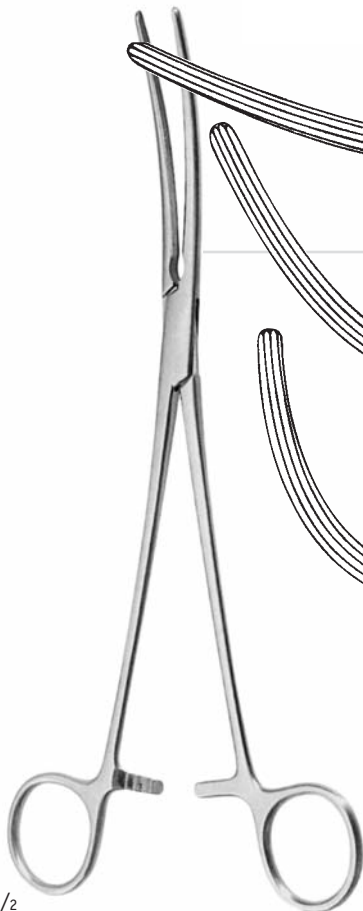
220 mm / 8³/₄"

1/2

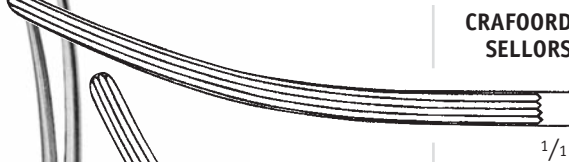
CRAFOORD
SELLORS

1/1

06-02-633

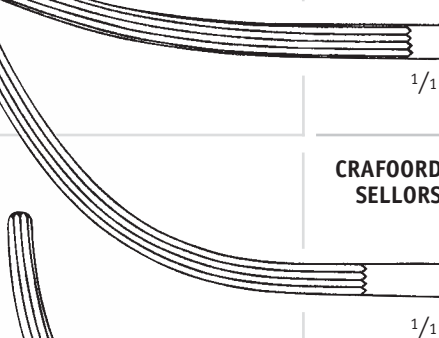
240 mm / 9¹/₂"CRAFOORD
SELLORS

1/1

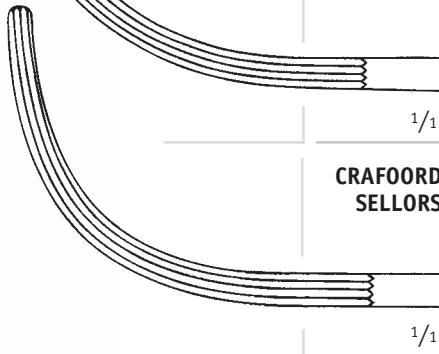

06-02-634



240 mm / 9¹/₂"CRAFOORD
SELLORS

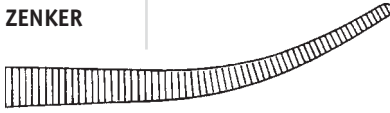

1/1

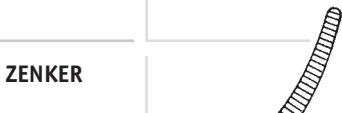

06-02-635

240 mm / 9¹/₂"

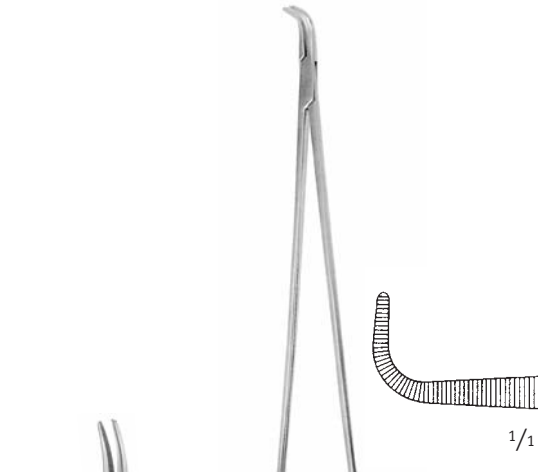
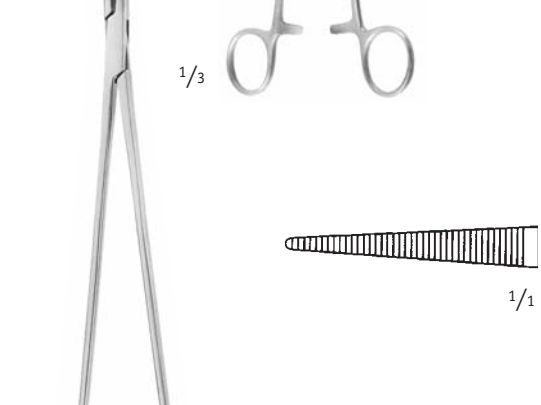
Artikel-Nr. Cat. No.	Gesamtlänge Total length			
02-10-047	295 mm /12"	ZENKER		
		$\frac{1}{1}$		
02-10-048	295 mm /12"	ZENKER		$\frac{1}{3}$
		$\frac{1}{1}$		

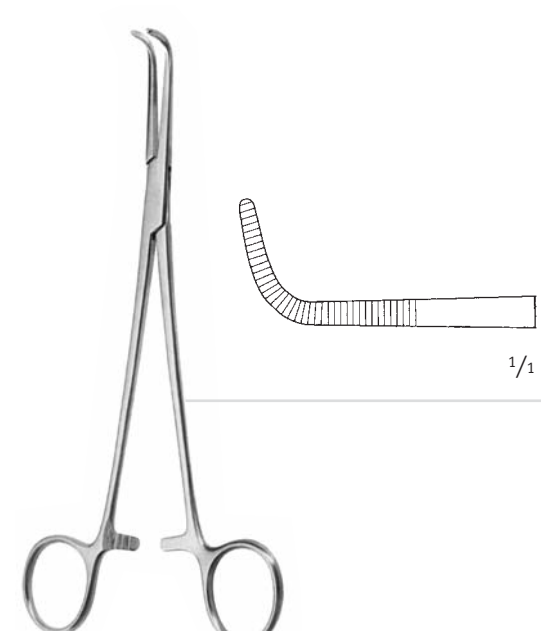
02-10-070	280 mm /11"	LAWRENCE		
		$\frac{1}{1}$		
				$\frac{1}{3}$

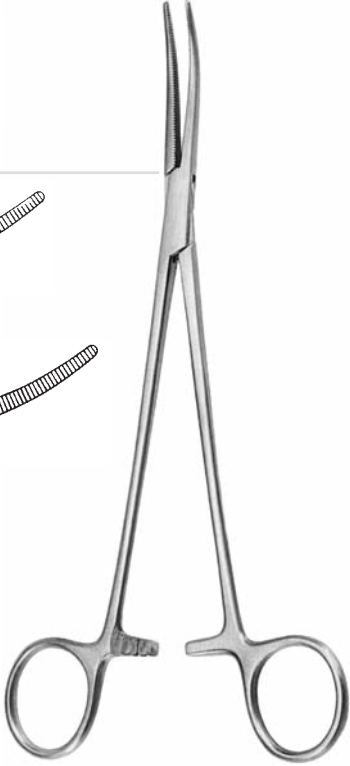
	MEEKER	Artikel-Nr. <i>Cat. No.</i> 02-58-240 02-58-241 02-58-242	Gesamtlänge <i>Total length</i> 180 mm / 7" 230 mm / 9" 280 mm / 11"
	BRIDGE	02-08-230	280 mm / 11"
	BRIDGE	02-08-231	280 mm / 11"
	KANTRO- WITZ	02-10-057 02-10-058 02-10-059	190 mm / 7 ¹ / ₂ " 240 mm / 9 ¹ / ₂ " 260 mm / 10 ¹ / ₄ "

Artikel-Nr. Cat. No.	Gesamtlänge Total length		
02-58-100	195 mm / 7 ³ / ₄ " Fig. 1	KELLY 1/1	
02-58-101	225 mm / 8 ³ / ₄ " Fig. 1	KELLY 1/1	
02-58-102	245 mm / 9 ³ / ₄ " Fig. 1	KELLY 1/1	
02-58-110	190 mm / 7 ¹ / ₂ " Fig. 2	KELLY 1/1	
02-58-111	220 mm / 8 ³ / ₄ " Fig. 2	KELLY 1/1	
02-58-112	240 mm / 9 ¹ / ₂ " Fig. 2	KELLY 1/1	
02-58-120	185 mm / 7 ¹ / ₄ " Fig. 3	KELLY 1/1	
02-58-121	215 mm / 8 ¹ / ₂ " Fig. 3	KELLY 1/1	
02-58-122	235 mm / 9 ¹ / ₄ " Fig. 3	KELLY 1/1	

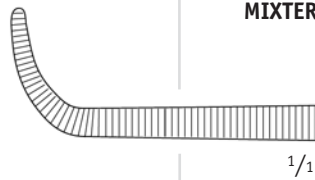
 Artikel-Nr.
 Cat. No.

 Gesamtlänge
 Total length

02-60-055

140 mm / 5¹/₂"

02-60-056

160 mm / 6¹/₄"

02-60-057

180 mm / 7"

02-60-058

230 mm / 9"

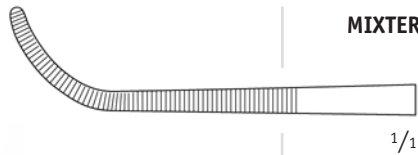

02-60-059

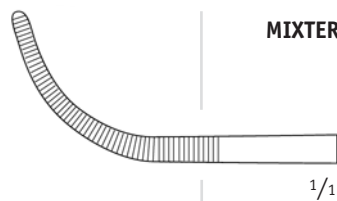
220 mm / 8³/₄"

02-10-055

230 mm / 9"

Artikel-Nr. Cat. No.	Gesamtlänge Total length
02-10-008	140 mm / 5½"

MICRO-ADSON

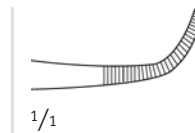

02-10-011	140 mm / 5½"
-----------	--------------

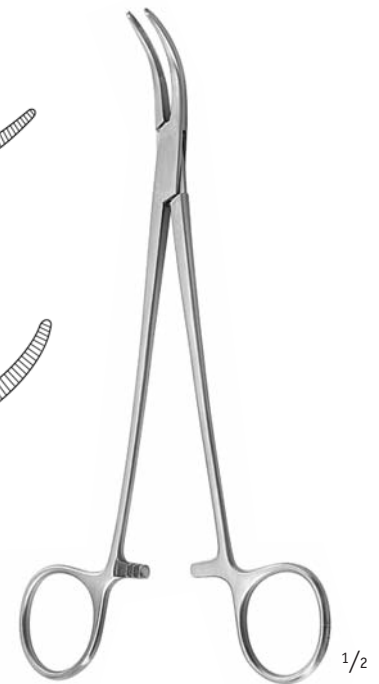
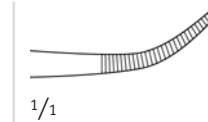

MIXTER BABY

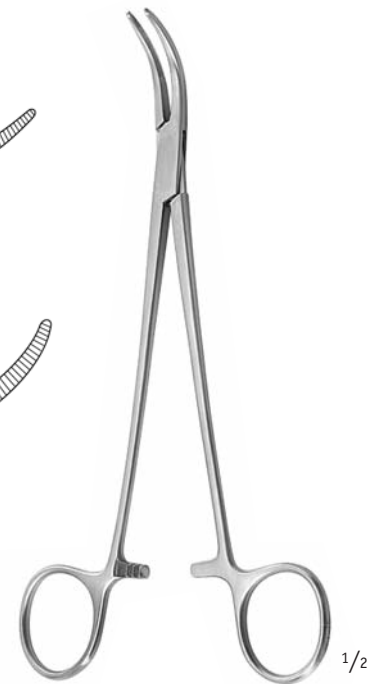
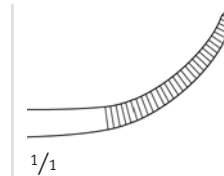

02-10-012	180 mm / 7"
-----------	-------------

MIXTER BABY

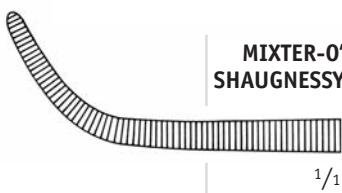
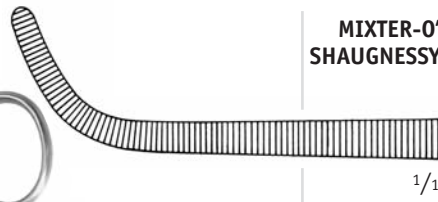

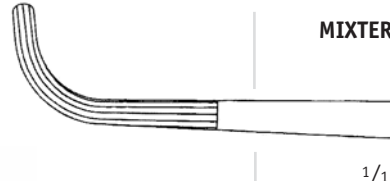
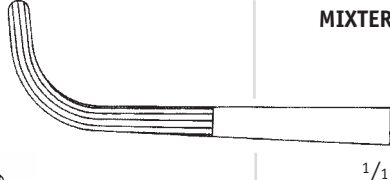
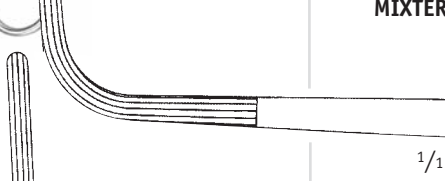
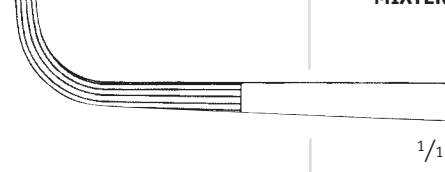
		MIXTER-O' SHAUGNESSY	02-60-049	155 mm / 6"
		MIXTER-O' SHAUGNESSY	02-10-050	190 mm / 7 1/2"
		MIXTER	02-60-060	180 mm / 7"
		MIXTER	02-10-061	220 mm / 8 3/4"
		MIXTER	02-10-062	250 mm / 9 3/4"
		MIXTER	02-60-063	280 mm / 11"

Artikel-Nr. Cat. No.	Gesamtlänge Total length	WICKSTROEM	1/1	1/2
02-10-051	210 mm / 8 ¹ / ₄ "	WICKSTROEM	1/1	1/2
02-60-052	240 mm / 9 ¹ / ₂ "	WICKSTROEM	1/1	1/2
02-60-053	220 mm / 8 ³ / ₄ "	MCQUIGG- MIXTER	1/1	1/2



1/2



LAHEY

1/1

 Artikel-Nr.
 Cat. No.

05-02-003

 Gesamtlänge
 Total length

190 mm / 7 1/2"



LAHEY

1/1

02-10-060

230 mm / 9"



1/2

MIKULICZ-
BABY

1/1

02-10-300

140 mm / 5 1/2"

Artikel-Nr. Cat. No.	Gesamtlänge Total length		
02-10-313	200 mm / 8"	MIKULICZ 1/1	
02-60-312	205 mm / 8"	MIKULICZ 1/1	
02-60-315	180 mm / 7"	MIKULICZ 1/1	
02-10-314	200 mm / 8"	MIKULICZ 1/1	

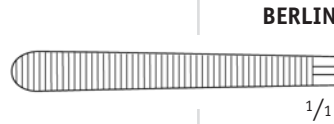

 Artikel-Nr.
 Cat. No.

 Gesamtlänge
 Total length

01-14-908

 145 mm / 5³/₄"

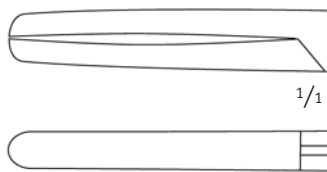
1/2

**PRESBY-
TERIAN
HOSPITAL**
01-14-909





 160 mm / 6¹/₄"

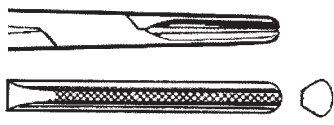

01-64-910

180 mm / 7"

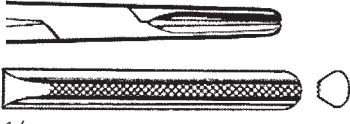
1/2

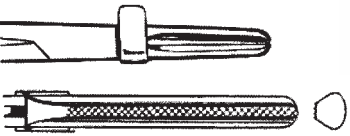

Artikel-Nr. Cat. No.	Gesamtlänge Total length	MURPHY	
01-64-911	150 mm / 6"		
		$1/1$	
01-14-911	180 mm / 7"		
		$1/1$	
01-14-913	200 mm / 8"		$1/2$
		$1/1$	

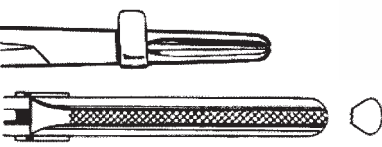
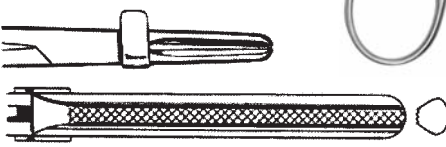
01-64-912	150 mm / 6"		
		$1/1$	
01-14-912	180 mm / 7"		
		$1/1$	
01-64-913	200 mm / 8"		$1/2$
		$1/1$	



1/2

**GUNNER-
HEY**

 Artikel-Nr.
Cat. No.

02-58-900

 Gesamtlänge
Total length
185 mm / 7¹/₄"

1/2

BROMPTON

02-58-901

150 mm / 6"



Artikel-Nr. Cat. No.	Gesamtlänge Total length
02-06-411	90 mm / 3 ¹ / ₂ "
	scharf sharp · tranchante · aguda · acuta

SCHAEDEL



2/3

02-06-401	55 mm / 2 ¹ / ₄ "
02-06-407	85 mm / 3 ¹ / ₄ "
	scharf sharp · tranchante · aguda · acuta

JONES



2/3

02-56-400	85 mm / 3 ¹ / ₄ "
	scharf, mit Schlauchhalter sharp, with tube holder · tranchante, avec porte-tuyau aguda, con porta-tubo · acuta, con porta tubo

JONES-CLIP

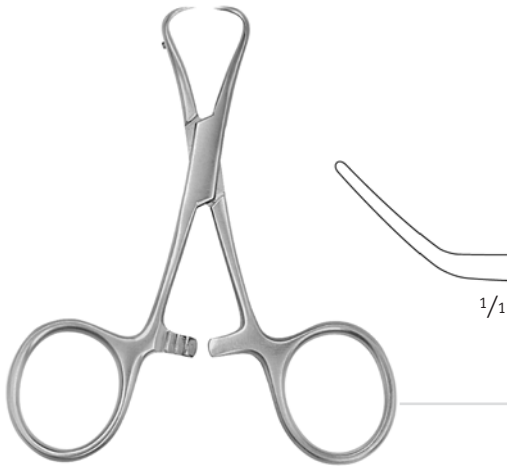

2/3

**BACKHAUS**
 Artikel-Nr.
 Cat. No.

 Gesamtlänge
 Total length

02-06-431

90 mm / 3¹/₂"

02-06-432

110 mm / 4¹/₄"

02-06-433

130 mm / 5"

02-56-434

150 mm / 6"

1/2

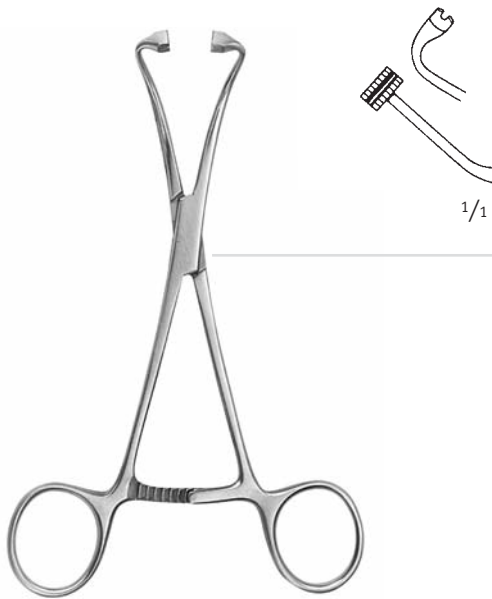
**PEERS
BERTRAM**

02-06-460

145 mm / 5³/₄"

weites Maul zur Schlauchfixierung
 wide jaw for tube fixation
 mors large pour la fixation du tuyau
 boca ancha para fijación de tubos
 morso spalancato per fissare il tubo

1/2



Artikel-Nr. Cat. No.	Gesamtlänge Total length
02-56-463	90 mm / 3 ¹ / ₂ "
02-56-464	100 mm / 4"
02-06-465	110 mm / 4 ¹ / ₄ "
02-06-464	130 mm / 5"
02-56-466	140 mm / 5 ¹ / ₂ "
02-56-467	160 mm / 6 ¹ / ₄ "

für Papierabdeckung
for paper clothes
pour la couverture du papier
para paños de papel
per copertura di carta

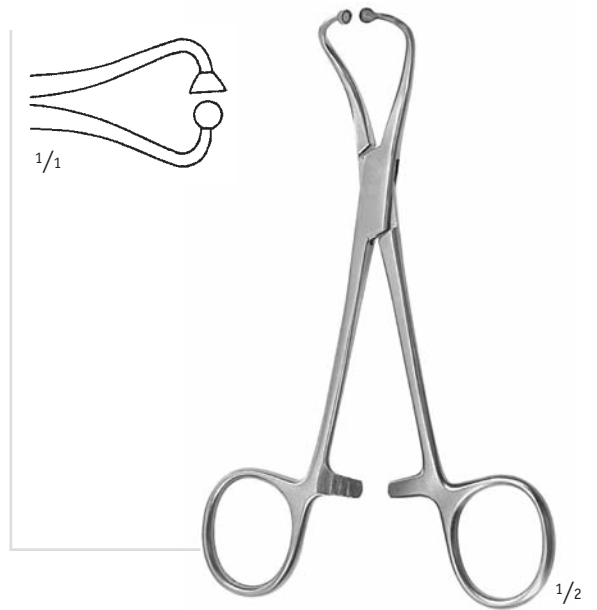

02-56-465	100 mm / 4"
-----------	-------------

stumpf
blunt
mousse
roma
smusso

TOHOKU

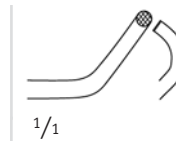

02-06-466	130 mm / 5"
-----------	-------------

stumpf
blunt
mousse
roma
smusso

TOHOKU

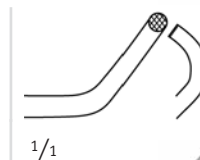

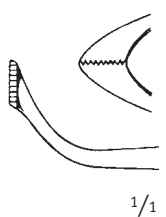

1/1

1/2

LORNA
 Artikel-Nr.
 Cat. No.

 Gesamtlänge
 Total length

02-56-460

90 mm / 3 1/2"

02-06-461

100 mm / 4"

02-06-463

130 mm / 5"

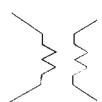
 fein gezahnt, breites Maul
 fine serrated, wide jaw
 dents fins, mors large
 delicadamente dentada, boca ancha
 con denti fini, marso largo
1/1
1 x 2

2/3

LANE

02-06-450

130 mm / 5"

02-06-451

155 mm / 6"

02-06-452

195 mm / 7 3/4"



Artikel-Nr.
 Cat. No.

Gesamtlänge
 Total length

02-56-042	140 mm / 5 ¹ / ₂ "
02-56-044	180 mm / 7"
02-06-046	200 mm / 8"
02-56-048	220 mm / 8 ³ / ₄ "
02-56-050	250 mm / 10"
02-06-058	270 mm / 10 ¹ / ₂ "
02-56-060	360 mm / 14 ¹ / ₄ "
02-56-062	400 mm / 16"

mit Sperre
 with ratchet · avec crémaillère
 con cerradura · con serratura

**GROSS-
 MAIER**



1/1

1/1



1/2

02-56-043	140 mm / 5 ¹ / ₂ "
02-56-045	180 mm / 7"
02-06-047	200 mm / 8"
02-56-049	220 mm / 8 ³ / ₄ "
02-56-051	250 mm / 10"
02-06-059	270 mm / 10 ¹ / ₂ "
02-56-061	360 mm / 14 ¹ / ₄ "
02-56-063	400 mm / 16"

mit Sperre
 with ratchet · avec crémaillère
 con cerradura · con serratura

**GROSS-
 MAIER**

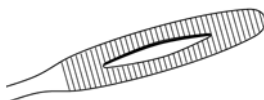

1/1





1/2

ULRICH
 Artikel-Nr.
 Cat. No.

 Gesamtlänge
 Total length
02-06-060220 mm / 8³/₄"**02-06-062**

250 mm / 10"

02-56-064270 mm / 10¹/₂"
 mit Sperre
 with ratchet · avec crémaillère
 con cerradura · con serratura



1/1

ULRICH**02-06-061**220 mm / 8³/₄"**02-06-063**

250 mm / 10"

02-56-065270 mm / 10¹/₂"
 mit Sperre
 with ratchet · avec crémaillère
 con cerradura · con serratura

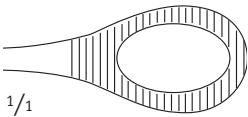
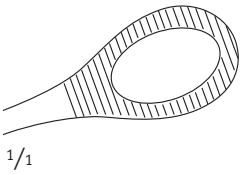
1/1

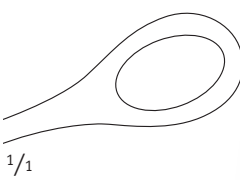
Artikel-Nr. Cat. No.	Gesamtlänge Total length		
02-06-112	180 mm / 7"	FOERSTER	
02-56-114	200 mm / 8"		
02-06-122	240 mm / 9 1/2"		
02-56-110	300 mm / 12"		
02-06-113	180 mm / 7"	FOERSTER	
02-56-115	200 mm / 8"		
02-06-123	240 mm / 9 1/2"		
02-56-111	300 mm / 12"		
02-56-116	180 mm / 7"	FOERSTER	
02-56-117	200 mm / 8"		
02-06-120	240 mm / 9 1/2"		
02-56-112	300 mm / 12"		
02-56-118	180 mm / 7"	FOERSTER	
02-56-119	200 mm / 8"		
02-06-121	240 mm / 9 1/2"		
02-56-113	300 mm / 12"		

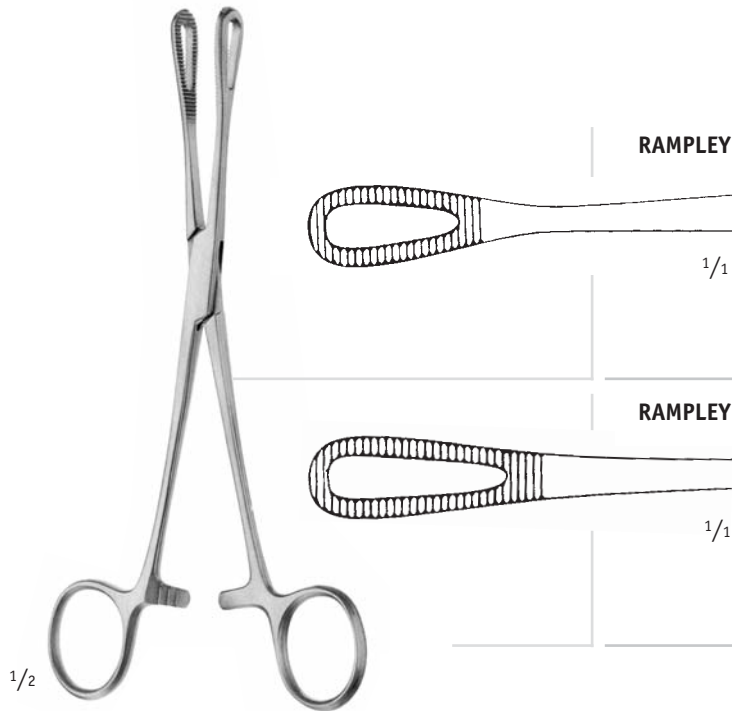

1/2

**RAMPLEY**
 Artikel-Nr.
 Cat. No.
02-06-116
 Gesamtlänge
 Total length

180 mm / 7"

 mit Sperre
 with ratchet · avec crémaillère
 con cerradura · con serratura
RAMPLEY**02-06-118**

250 mm / 10"

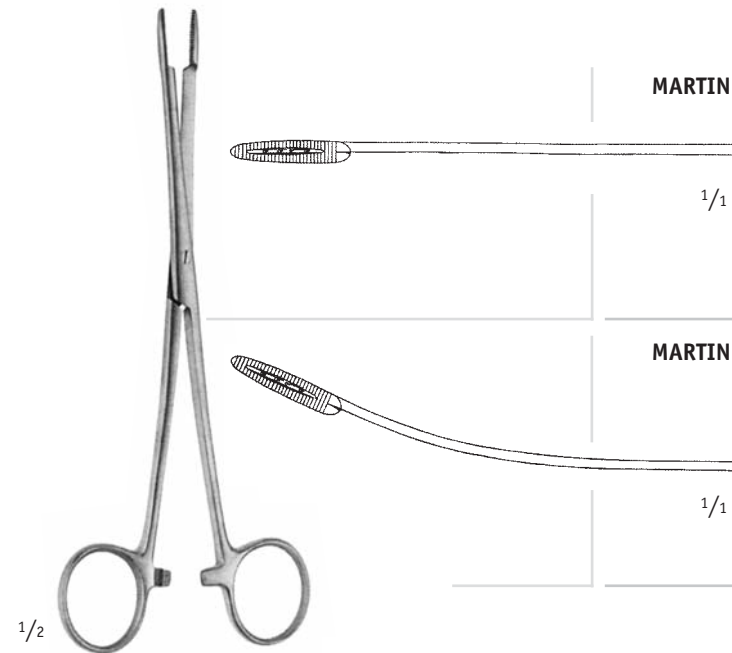
 mit Sperre
 with ratchet · avec crémaillère
 con cerradura · con serratura
**MARTIN****02-56-020**170 mm / 6³/₄"
 mit Sperre
 with ratchet · avec crémaillère
 con cerradura · con serratura
MARTIN**02-06-021**170 mm / 6³/₄"
 mit Sperre
 with ratchet · avec crémaillère
 con cerradura · con serratura

Artikel-Nr. Cat. No.	Gesamtlänge Total length
02-06-004	130 mm / 5"
Sinusklemme ohne Sperre Sinus forceps without ratchet Pince à sinus sans crémaillère Pinza para seno sin cerradura Pinze sinus senza serratura	
02-06-006	160 mm / 6 ¹ / ₄ "
Sinusklemme ohne Sperre Sinus forceps without ratchet Pince à sinus sans crémaillère Pinza para seno sin cerradura Pinze sinus senza serratura	
02-06-008	180 mm / 7"
Sinusklemme ohne Sperre Sinus forceps without ratchet Pince à sinus sans crémaillère Pinza para seno sin cerradura Pinze sinus senza serratura	

LISTER



LISTER



LISTER

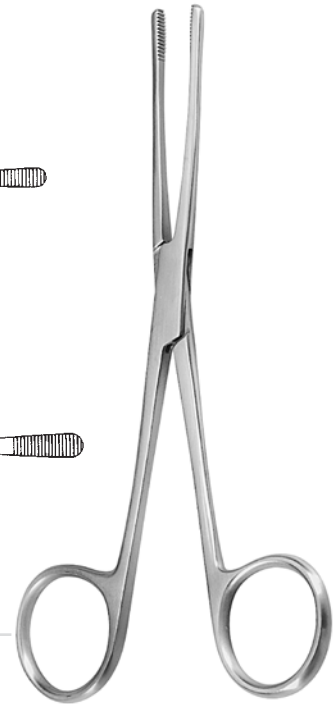

1/2

02-08-959	190 mm / 7 ¹ / ₂ "
Sinusklemme ohne Sperre Sinus forceps without ratchet Pince à sinus sans crémaillère Pinza para seno sin cerradura Pinze sinus senza serratura	
02-08-957	190 mm / 7 ¹ / ₂ "
Sinusklemme ohne Sperre Sinus forceps without ratchet Pince à sinus sans crémaillère Pinza para seno sin cerradura Pinze sinus senza serratura	

SCHNIDT

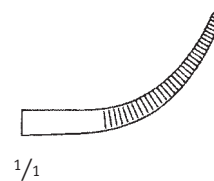

SCHNIDT

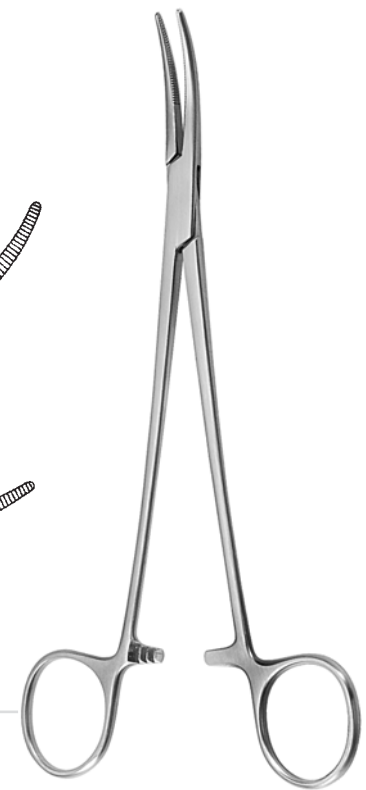
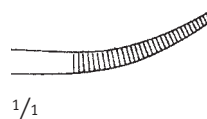

1/2

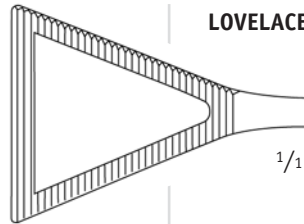

1/2

 Artikel-Nr.
 Cat. No.

05-51-040

 Gesamtlänge
 Total length

200 mm / 8"



1/2

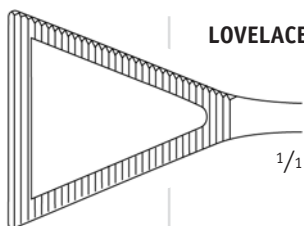

LOVELACE

05-51-041

200 mm / 8"

Artikel-Nr.
 Cat. No.

Gesamtlänge
 Total length

06-52-946

305 mm / 12¹/₂"

HARRINGTON



1/1



1/3

06-52-947

290 mm / 11³/₄"

HARRINGTON



1/1



1/3

06-52-948

310 mm / 12¹/₂"

HARRINGTON



1/1

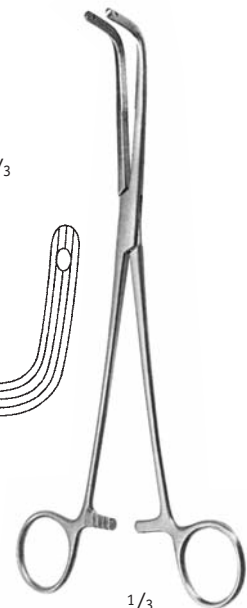

1/3

06-52-949

240 mm / 9¹/₂"

FINO-
 CHIETTO

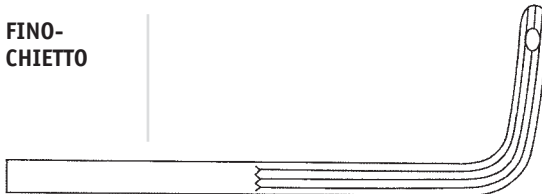

1/1

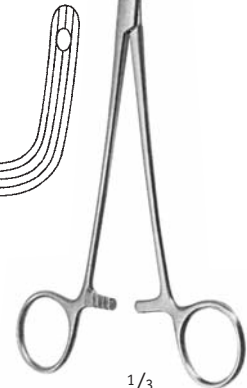

1/3

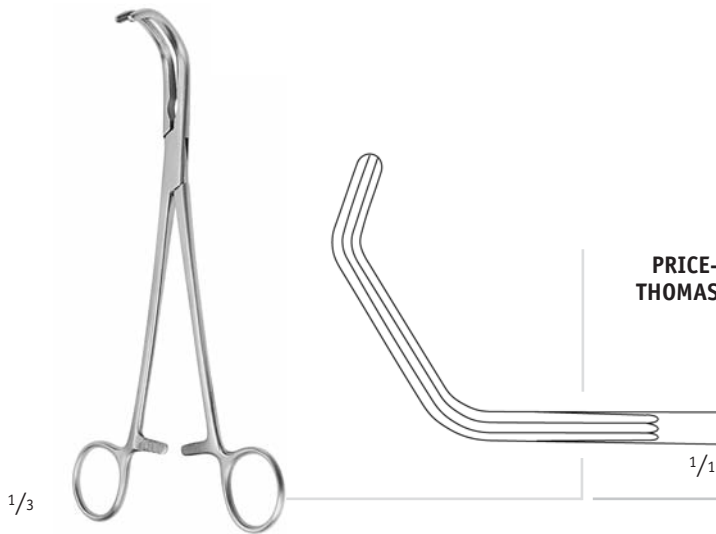
 Artikel-Nr.
 Cat. No.

06-02-950

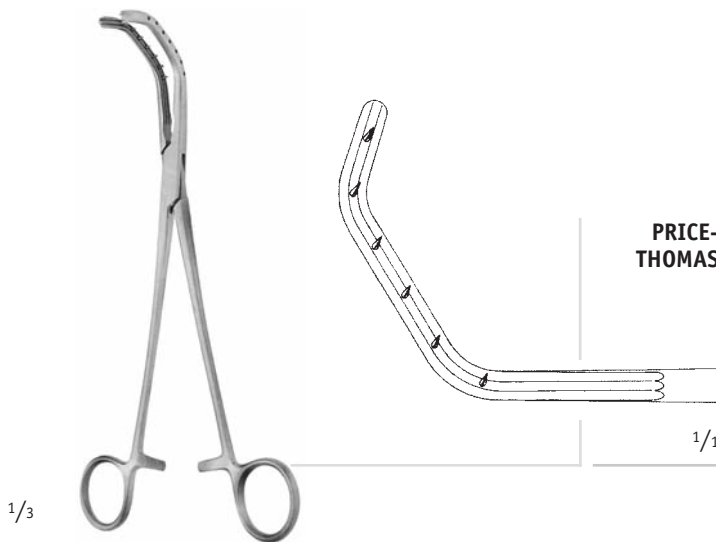
 Gesamtlänge
 Total length
220 mm / 8³/₄"

06-02-951

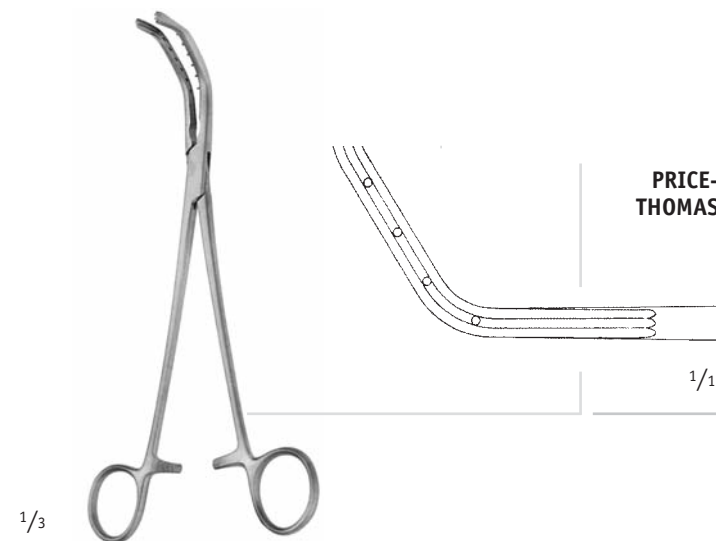
220 mm / 8³/₄"
 links
 left · à gauche · izquierda · sinistra

06-02-952

220 mm / 8³/₄"
 rechts
 right · à droite · derecha · destra

Artikel-Nr. Cat. No.	Gesamtlänge Total length
06-52-953	230 mm / 9"
links <i>left · à gauche · izquierda · sinistra</i>	
06-52-954	230 mm / 9"
rechts <i>right · à droite · derecha · destra</i>	

SAROT

1/1

SAROT

1/1



1/2

06-02-960	230 mm / 9"
Präparier- und Ligaturklemmen <i>Dissecting and Ligature Forceps</i> <i>Pincers à dissection et à ligature</i> <i>Pinzas para disección y ligaduras</i> <i>Pinze per dissezione e per legature (Passafili)</i>	
06-02-961	230 mm / 9"
Präparier- und Ligaturklemmen <i>Dissecting and Ligature Forceps</i> <i>Pincers à dissection et à ligature</i> <i>Pinzas para disección y ligaduras</i> <i>Pinze per dissezione e per legature (Passafili)</i>	

SEMB

1/1

SEMB

1/1

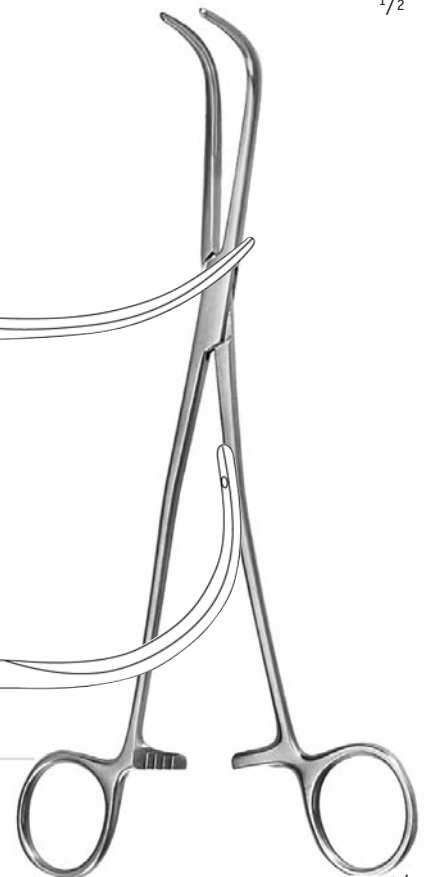

1/2

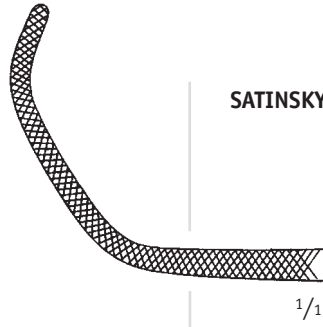

SATINSKY

 Artikel-Nr.
 Cat. No.

06-02-600

 Gesamtlänge
 Total length

150 mm / 6"



SATINSKY

06-02-602

260 mm / 10¹/₄"
 für die Vena Cava
 for Vena cava · pour la vena cava
 para la vena cava · per la vena cava

1/2

Artikel-Nr. Cat. No.	Gesamtlänge Total length
06-02-604	260 mm / 10 ¹ / ₄ " Fig. 1 für die Vena Cava <i>for Vena cava · pour la vena cava</i> <i>para la vena cava · per la vena cava</i>
06-02-605	260 mm / 10 ¹ / ₄ " Fig. 2 für die Vena Cava <i>for Vena cava · pour la vena cava</i> <i>para la vena cava · per la vena cava</i>

SATINSKY

1/1

SATINSKY

1/1

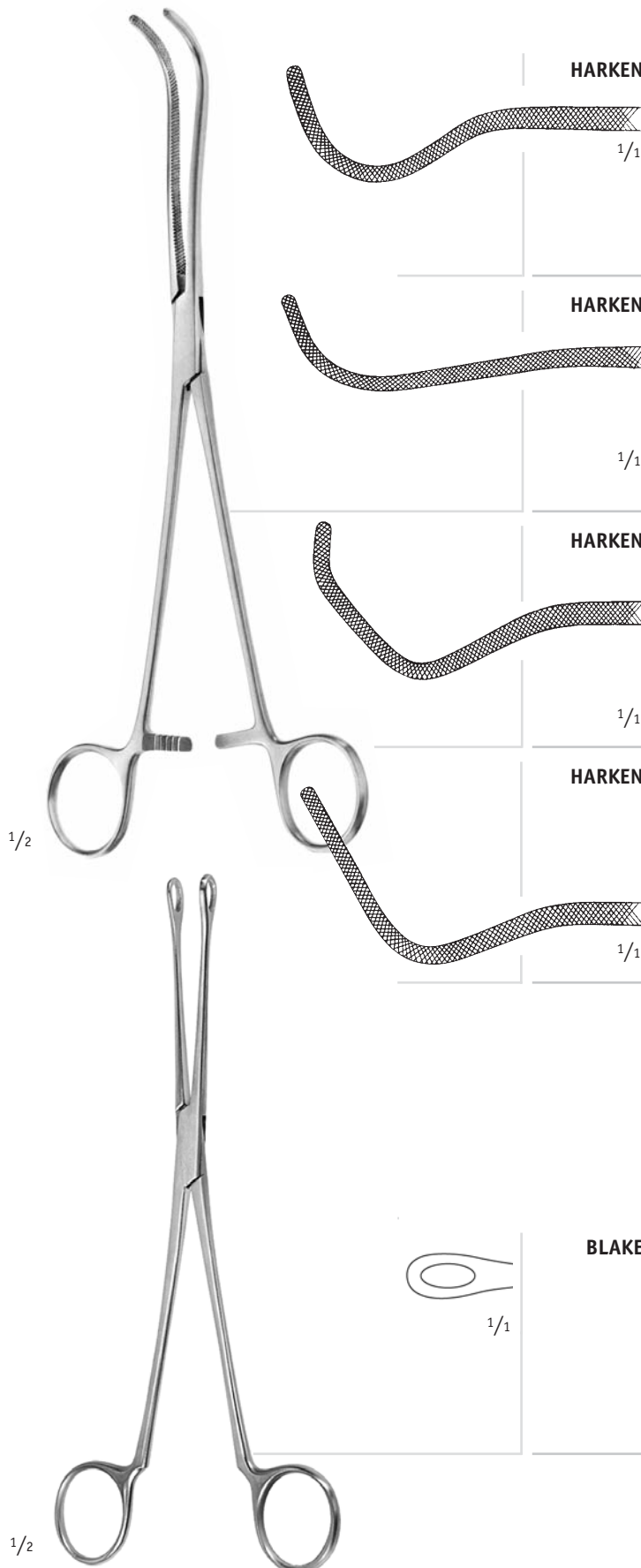

1/2

 Artikel-Nr.
 Cat. No.

 Gesamtlänge
 Total length

06-02-637

 240 mm / 9¹/₂"
 Fig. 1

HARKEN

1/1

06-52-639

 240 mm / 9¹/₂"
 Fig. 2

HARKEN

1/1

06-02-639

 240 mm / 9¹/₂"
 Fig. 3

HARKEN

1/1

06-02-638

 240 mm / 9¹/₂"
 Fig. 4

HARKEN

1/1

BLAKE

05-02-220

210 mm / 8¹/₄"
 Embolusfasszange
 Embolus grasping forceps
 Pince à saisir l'embolus
 Pinzas para coger émbolo
 Pinza afferrare embolo

1/1

Artikel-Nr. Cat. No.	Gesamtlänge Total length
05-01-012	130 mm / 5"
05-51-013	140 mm / 5½"

**ALLIS-
BABY**



1/1
4 : 5



1/2

05-01-015	150 mm / 6"
05-51-016	190 mm / 7½"
05-51-017	250 mm / 10"

ALLIS



1/1
4 : 5



1/2

05-01-016	150 mm / 6"
05-01-017	190 mm / 7½"
06-02-938	220 mm / 8¾"
05-01-018	240 mm / 9½"
05-51-019	300 mm / 12"

ALLIS



1/1
5 : 6

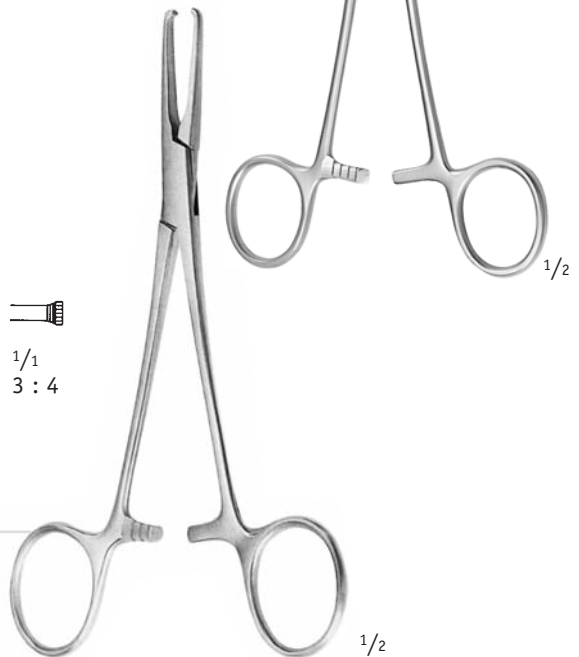

1/2

05-01-025	150 mm / 6"
05-01-026	195 mm / 7¾"

**JUDD-
ALLIS**



1/1
3 : 4

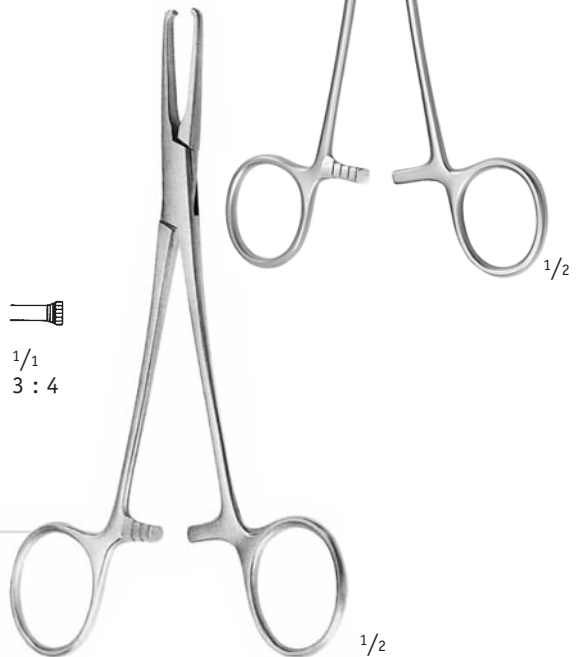

1/2

ATRAUMA

DE BAKEY

 $\frac{1}{2}$

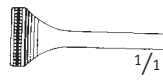
 $\frac{1}{2}$

 $\frac{1}{1}$
ALLIS

 Artikel-Nr.
 Cat. No.

05-01-092

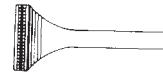
 Gesamtlänge
 Total length

 160 mm / 6 $\frac{1}{4}$ "

 $\frac{1}{1}$
ALLIS
05-01-095

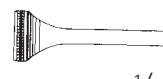
200 mm / 8"

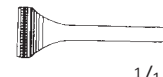

 $\frac{1}{1}$
ALLIS
05-01-096

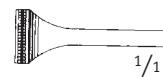
 220 mm / 8 $\frac{3}{4}$ "

 $\frac{1}{1}$
ALLIS
05-01-097

250 mm / 10"

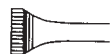
 $\frac{1}{1}$
ALLIS
05-01-099





300 mm / 12"



 $\frac{1}{1}$

6:7

**THOMS-
ALLIS**
05-01-020

200 mm / 8"

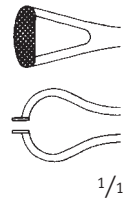
Artikel-Nr. Cat. No.	Gesamtlänge Total length	BABCOCK	
05-01-030	160 mm / 6 ¹ / ₄ "	 1/1	
05-01-031	180 mm / 7"	 1/1	
05-01-033	200 mm / 8"	 1/1	1/2
06-02-934	240 mm / 9 ¹ / ₂ "	 1/1	



BABCOCK

Artikel-Nr.
Cat. No.

05-51-048

Gesamtlänge
Total length

160 mm / 6¹/₄"

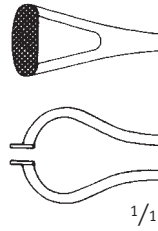

BABCOCK

05-51-049

200 mm / 8"

ATRAUMA



DE BAKEY

TC



BABCOCK

05-01-050

160 mm / 6¹/₄"



BABCOCK

05-01-052

200 mm / 8"

Artikel-Nr. Cat. No.	Gesamtlänge Total length
05-01-040	180 mm / 7"
05-01-041	200 mm / 8"
05-01-042	200 mm / 8"
06-02-930	230 mm / 9"

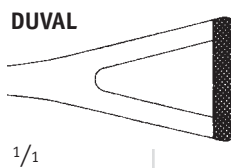
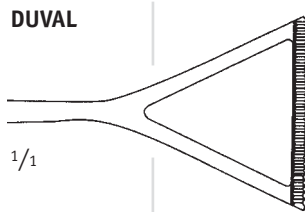

1/2

05-51-043	200 mm / 8"
-----------	-------------

TC



1/2

ATRAUMA

DE BAKEY

1/2

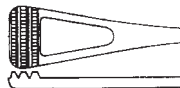
SCHEIBE

1/1

 Artikel-Nr.
 Cat. No.

05-51-060

 Gesamtlänge
 Total length

180 mm / 7"

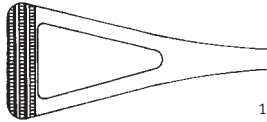
SCHEIBE

1/1

05-01-061

200 mm / 8"

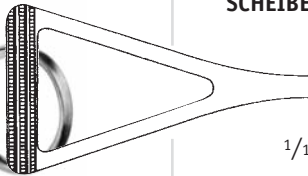
SCHEIBE

1/1

05-01-062

230 mm / 9"

LITTLEWOOD

05-15-216

190 mm / 7¹/₂"

2:3 Zähne

2:3 teeth · 2:3 dents · 2:3 dientes · 2:3 denti



1/2

Artikel-Nr.
 Cat. No.

Gesamtlänge
 Total length

05-01-028

165 mm / 6¹/₂"

WILLIAMS



1/1



1/2

05-15-180

230 mm / 9"

Herzklappen-Fasszange
Cardiac valve grasping forceps
Pince à saisir la valvule cardiaque
Pinza de corazón-valvula
Pinze per afferrare il cuore-valvola

TEALE











1/1
 3 : 4









1/2

Folgende Hartmetalleinlagen werden für **REBSTOCK TC/diamantierte** Nadelhalter verwendet:
 The **REBSTOCK TC/diamond dust coated** Needle Holders are equipped with the following tungsten carbide inserts:
 Les inserts suivants en métal dur sont utilisés pour les porte-aiguilles **REBSTOCK TC/diamantés**:
 Las porta-agujas **REBSTOCK TC/diamantadas** están equipadas con las siguientes plaquitas de carburo de tungsteno:
 I portaghi **REBSTOCK TC/diamantato** dispongono delle seguenti placche in carburo di tungsteno:

		Teilung structure structure estructura struttura	empfohlen für Nahtmaterial recommended for suture material recommandé pour matériel de suture recomendado para material de sutura raccomandato per materiale di suture
	normal regular régulière regular regolare	0,5 mm	>3/0
	mini mini mini mini mini	0,4 mm	4/0 - 6/0
	mikro micro micro micro micro	0,3 mm	5/0 - 8/0
	diamantiert diamond coated diamanté diamantada diamantato	-	7/0 - 10/0
	glatt smooth lisse lisa piatto	-	7/0 - 10/0
		TC	

Artikel-Nr. Cat. No.	Gesamtlänge Total length			
02-13-200	125 mm / 5"	CONVERSE	 1/1	
02-13-204	125 mm / 5"	DERF	 1/1	
02-13-008	125 mm / 5"	DERF	 1/1 0,4 mm	

TC

02-13-201	130 mm / 5 ¹ / ₈ "	HALSEY	 1/1	
02-13-205	130 mm / 5 ¹ / ₈ "	HALSEY	 1/1	
02-13-010	120 mm / 4 ³ / ₄ " glattes Maul smooth jaw · mors lisse · boca lisa · morso piatto	HALSEY	 1/1	
02-13-012	130 mm / 5 ¹ / ₈ "	HALSEY	 1/1 0,4 mm	
02-13-011	130 mm / 5 ¹ / ₈ "	CONVERSE	 1/1 0,4 mm	

TC

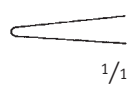
**WEBSTER**
 Artikel-Nr.
 Cat. No.

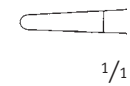
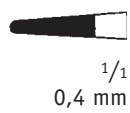
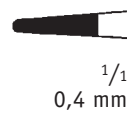
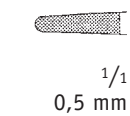
 Gesamtlänge
 Total length
02-63-202115 mm / 4¹/₂"**02-13-202**130 mm / 5¹/₈"
 glattes Maul
 smooth jaw · mors lisse
 boca lisa · morso piatto
**WEBSTER****02-63-014**120 mm / 4³/₄"**02-13-014**130 mm / 5¹/₈"
 glattes Maul
 smooth jaw · mors lisse
 boca lisa · morso piatto
TC**NEIVERT****02-63-017**130 mm / 5¹/₈"
 mit aufgebogenem Daumenring
 with offset ring · avec anneau courbe
 con anillo acodado · con anelli sfalsati
**NEIVERT****02-63-018**130 mm / 5¹/₈"
 für Linkshänder
 for left-handed · pour la main gauche
 para zurdos · per mancino
TC**BAUM-
GARTNER****02-63-016**

125 mm / 5"

02-13-015140 mm / 5¹/₂"









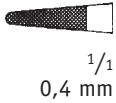

Artikel-Nr. Cat. No.	Gesamtlänge Total length		
02-13-218	150 mm / 6"	CRILE- WOOD	 1/1
02-63-220	180 mm / 7"		
02-63-221	200 mm / 8"		

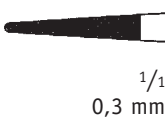

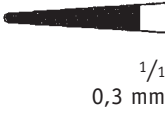

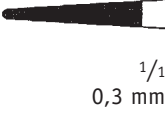

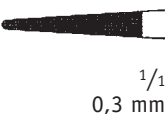

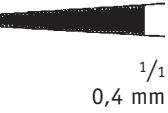









02-13-013	150 mm / 6"	BABY- CRILE- WOOD	 1/1 0,4 mm
02-13-016	145 mm / 5 ³ / ₄ "	CRILE- WOOD	 1/1 0,4 mm
02-63-013	150 mm / 6" für Linkshänder · for left-handed pour la main gauche · para zurdos · per mancino	CRILE- WOOD	 1/1 0,4 mm
02-13-017	180 mm / 7"	CRILE- WOOD	 1/1 0,4 mm
02-13-019	200 mm / 8"	CRILE- WOOD	 1/1 0,4 mm
02-13-021	305 mm / 12 ¹ / ₂ "	CRILE- WOOD	 1/1 0,4 mm



TC

		Artikel-Nr. Cat. No.	Gesamtlänge Total length
	 $\frac{1}{1}$ 0,4 mm	DE BAKEY 02-63-023	165 mm / 6 $\frac{1}{2}$ "
		TC	
	 $\frac{1}{1}$ 0,3 mm	DE BAKEY 02-63-024	160 mm / 6 $\frac{1}{4}$ " Schlankes Modell <i>Delicate pattern · Modèle délicat</i> <i>Modelo delgado · Modello fino</i>
	 $\frac{1}{1}$ 0,3 mm	DE BAKEY 02-13-025	180 mm / 7" Schlankes Modell <i>Delicate pattern · Modèle délicat</i> <i>Modelo delgado · Modello fino</i>
	 $\frac{1}{1}$ 0,3 mm	DE BAKEY 02-63-026	210 mm / 8 $\frac{1}{4}$ " Schlankes Modell <i>Delicate pattern · Modèle délicat</i> <i>Modelo delgado · Modello fino</i>
	 $\frac{1}{1}$ 0,3 mm	DE BAKEY 02-13-027	230 mm / 9" Schlankes Modell <i>Delicate pattern · Modèle délicat</i> <i>Modelo delgado · Modello fino</i>
	 $\frac{1}{1}$ 0,4 mm	DE BAKEY 02-13-040	310 mm / 12 $\frac{1}{2}$ " Schlankes Modell <i>Delicate pattern · Modèle délicat</i> <i>Modelo delgado · Modello fino</i>
		TC	

Artikel-Nr. Cat. No.	Gesamtlänge Total length		
02-13-032	150 mm / 6"	DE BAKEY	 1/1 0,4 mm
02-13-035	180 mm / 7"	DE BAKEY	 1/1 0,4 mm
02-63-035	200 mm / 8"	DE BAKEY	 1/1 0,4 mm
02-13-036	230 mm / 9"	DE BAKEY	 1/1 0,4 mm
02-13-037	250 mm / 10"	DE BAKEY	 1/1 0,4 mm
02-13-038	300 mm / 12"	DE BAKEY	 1/1 0,4 mm
02-63-039	370 mm / 14 ³ / ₄ "	DE BAKEY	 1/1 0,4 mm
TC			
02-63-064	140 mm / 5 ¹ / ₂ "	MAYO-HEGAR	 1/1 0,5 mm
02-13-065	150 mm / 6"	MAYO-HEGAR	 1/1 0,5 mm
02-13-066	180 mm / 7"	MAYO-HEGAR	 1/1 0,5 mm
02-13-067	200 mm / 8"	MAYO-HEGAR	 1/1 0,5 mm
02-63-067	240 mm / 9 ¹ / ₂ "	MAYO-HEGAR	 1/1 0,5 mm
02-63-068	260 mm / 10 ¹ / ₄ "	MAYO-HEGAR	 1/1 0,5 mm
02-13-069	300 mm / 12"	MAYO-HEGAR	 1/1 0,5 mm
02-63-069	160 mm / 6 ¹ / ₄ "	MAYO-HEGAR	 1/1
02-63-070	180 mm / 7" glattes Maul smooth jaw · mors lisse · boca lisa · morso piatto	MAYO-HEGAR	 1/1















1/2

		Artikel-Nr. Cat. No.	Gesamtlänge Total length	
 1/1 0,4 mm	RYDER	02-13-044	135 mm / 5 ¹ / ₄ "	
		02-63-044	150 mm / 6"	
	RYDER	02-13-045	180 mm / 7"	
	RYDER	02-13-046	200 mm / 8"	
		02-63-046	230 mm / 9"	
	RYDER	02-13-047	265 mm / 10 ¹ / ₂ "	
	 1/1	RYDER	02-63-047	135 mm / 5 ¹ / ₄ " glattes Maul <i>smooth jaw · mors lisse · boca lisa · morso piatto</i>
		RYDER	02-13-074	150 mm / 6" glattes Maul <i>smooth jaw · mors lisse · boca lisa · morso piatto</i>
	 1/1	RYDER	02-13-075	180 mm / 7" glattes Maul <i>smooth jaw · mors lisse · boca lisa · morso piatto</i>
		RYDER	02-63-075	200 mm / 8" glattes Maul <i>smooth jaw · mors lisse · boca lisa · morso piatto</i>
 1/1	RYDER	02-13-076	230 mm / 9" glattes Maul <i>smooth jaw · mors lisse · boca lisa · morso piatto</i>	

TC





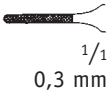
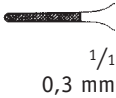
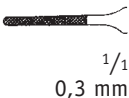
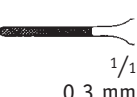
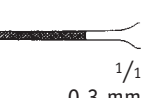

Artikel-Nr. Cat. No.	Gesamtlänge Total length			
02-63-080	140 mm / 5 ¹ / ₂ " Schlankes Modell <i>Delicate pattern · Modèle délicat</i> <i>Modelo delgado · Modello fino</i>	HEGAR-vascular	 1/1 0,3 mm	 1/2
02-63-081	180 mm / 7" Schlankes Modell <i>Delicate pattern · Modèle délicat</i> <i>Modelo delgado · Modello fino</i>	HEGAR-vascular	 1/1 0,3 mm	
02-63-082	200 mm / 7 ³ / ₄ " Schlankes Modell <i>Delicate pattern · Modèle délicat</i> <i>Modelo delgado · Modello fino</i>	HEGAR-vascular	 1/1 0,3 mm	
02-63-083	230 mm / 9" Schlankes Modell <i>Delicate pattern · Modèle délicat</i> <i>Modelo delgado · Modello fino</i>	HEGAR-vascular	 1/1 0,3 mm	
TC				
02-63-085	140 mm / 5 ¹ / ₂ " Schlankes Modell <i>Delicate pattern · Modèle délicat</i> <i>Modelo delgado · Modello fino</i>	Micro-vascular	 1/1 0,3 mm	 1/2
02-63-086	175 mm / 7" Schlankes Modell <i>Delicate pattern · Modèle délicat</i> <i>Modelo delgado · Modello fino</i>	Micro-vascular	 1/1 0,3 mm	
02-63-087	200 mm / 7 ³ / ₄ " Schlankes Modell <i>Delicate pattern · Modèle délicat</i> <i>Modelo delgado · Modello fino</i>	Micro-vascular	 1/1 0,3 mm	
02-63-088	230 mm / 9" Schlankes Modell <i>Delicate pattern · Modèle délicat</i> <i>Modelo delgado · Modello fino</i>	Micro-vascular	 1/1 0,3 mm	
TC				



		Artikel-Nr. Cat. No.	Gesamtlänge Total length
	RYDER Vascular	02-13-054	125 mm / 5" Schlankes Modell <i>Delicate pattern · Modèle délicat Modelo delgado · Modello fino</i>
	RYDER Vascular	02-13-055	155 mm / 6" SSchlankes Modell <i>Delicate pattern · Modèle délicat Modelo delgado · Modello fino</i>
	RYDER Vascular	02-13-056	175 mm / 7" Schlankes Modell <i>Delicate pattern · Modèle délicat Modelo delgado · Modello fino</i>
	RYDER Vascular	02-13-057	200 mm / 8" Schlankes Modell <i>Delicate pattern · Modèle délicat Modelo delgado · Modello fino</i>
	RYDER Vascular	02-63-058	225 mm / 9" Schlankes Modell <i>Delicate pattern · Modèle délicat Modelo delgado · Modello fino</i>
	RYDER Vascular	02-63-059	260 mm / 10 ¹ / ₄ " Schlankes Modell <i>Delicate pattern · Modèle délicat Modelo delgado · Modello fino</i>
		TC	

1/2

TC

Artikel-Nr. Cat. No.	Gesamtlänge Total length		
02-63-050	140 mm / 5 ¹ / ₂ "	RYDER Vascular	 1/1
	Schlankes Modell, diamantiertes Maul <i>Delicate pattern, diamond-coated jaw</i> <i>Modèle délicat, mors diamanté</i> <i>Modelo delgado, boca diamantada</i> <i>Modello fino, morso diamantato</i>		
02-63-051	160 mm / 6 ¹ / ₄ "	RYDER Vascular	 1/1
	Schlankes Modell, diamantiertes Maul <i>Delicate pattern, diamond-coated jaw</i> <i>Modèle délicat, mors diamanté</i> <i>Modelo delgado, boca diamantada</i> <i>Modello fino, morso diamantato</i>		
02-63-052	180 mm / 7"	RYDER Vascular	 1/1
	Schlankes Modell, diamantiertes Maul <i>Delicate pattern, diamond-coated jaw</i> <i>Modèle délicat, mors diamanté</i> <i>Modelo delgado, boca diamantada</i> <i>Modello fino, morso diamantato</i>		
02-63-053	220 mm / 8 ³ / ₄ "	RYDER Vascular	 1/1
	Schlankes Modell, diamantiertes Maul <i>Delicate pattern, diamond-coated jaw</i> <i>Modèle délicat, mors diamanté</i> <i>Modelo delgado, boca diamantada</i> <i>Modello fino, morso diamantato</i>		
02-63-054	250 mm / 10"	RYDER Vascular	 1/1
	Schlankes Modell, diamantiertes Maul <i>Delicate pattern, diamond-coated jaw</i> <i>Modèle délicat, mors diamanté</i> <i>Modelo delgado, boca diamantada</i> <i>Modello fino, morso diamantato</i>		
	Maul diamantbeschichtet <i>Mouth diamond dust coated · Bouche diamantée</i> <i>Boca diamantada · Bocca diamantata</i>		



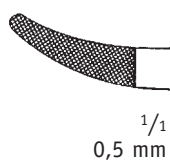
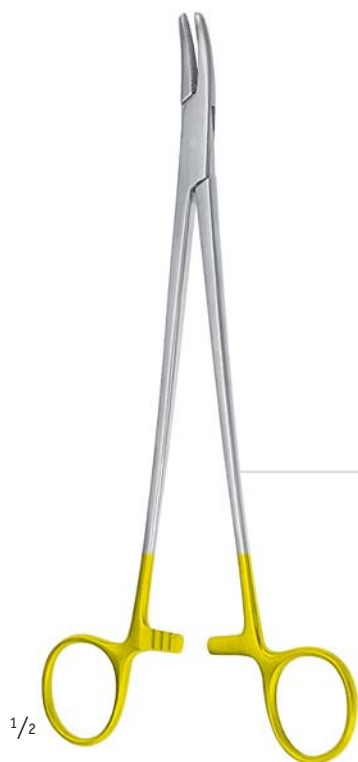

HEANEY

 Artikel-Nr.
 Cat. No.

02-13-081

 Gesamtlänge
 Total length

200 mm / 8"

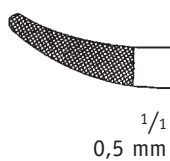

HEANEY

02-13-084

260 mm / 10 $\frac{1}{4}$ "

TC

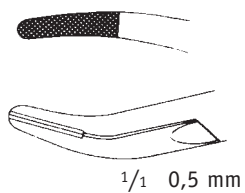
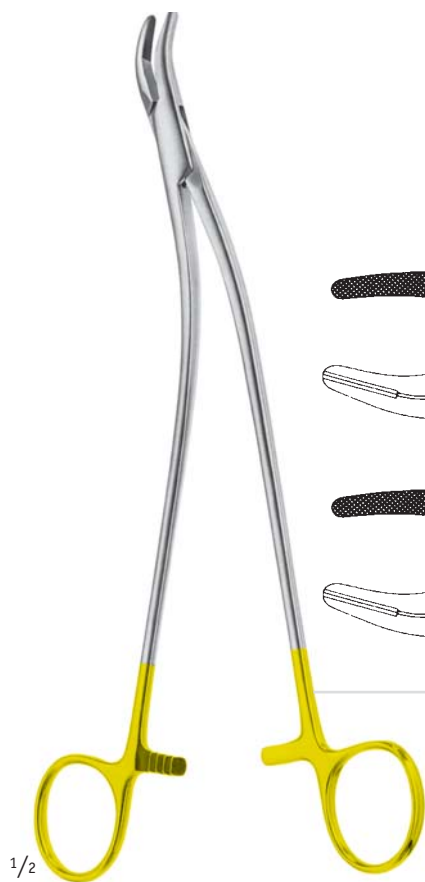

STRATTE



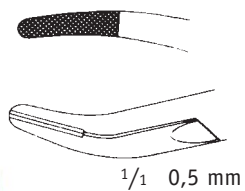



02-13-095

210 mm / 8 $\frac{1}{4}$ "

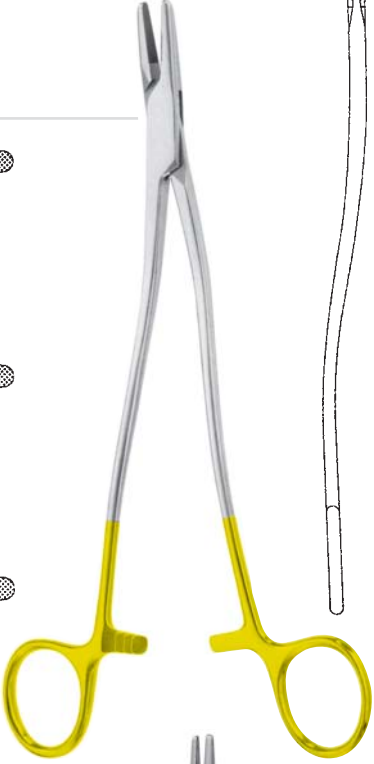
STRATTE

02-13-096

230 mm / 9"

Artikel-Nr. Cat. No.	Gesamtlänge Total length			
02-13-100	200 mm / 8"	BOZEMANN	 1/1 0,5 mm	 
02-13-101	240 mm / 9 1/2"	BOZEMANN	 1/1 0,5 mm	
02-63-103	260 mm / 10 1/4"	BOZEMANN	 1/1 0,5 mm	
02-13-102	300 mm / 12"	BOZEMANN	 1/1 0,5 mm	
TC				
02-13-042	275 mm / 10 3/4"	WANGEN-STEEN	 1/1 0,5 mm	

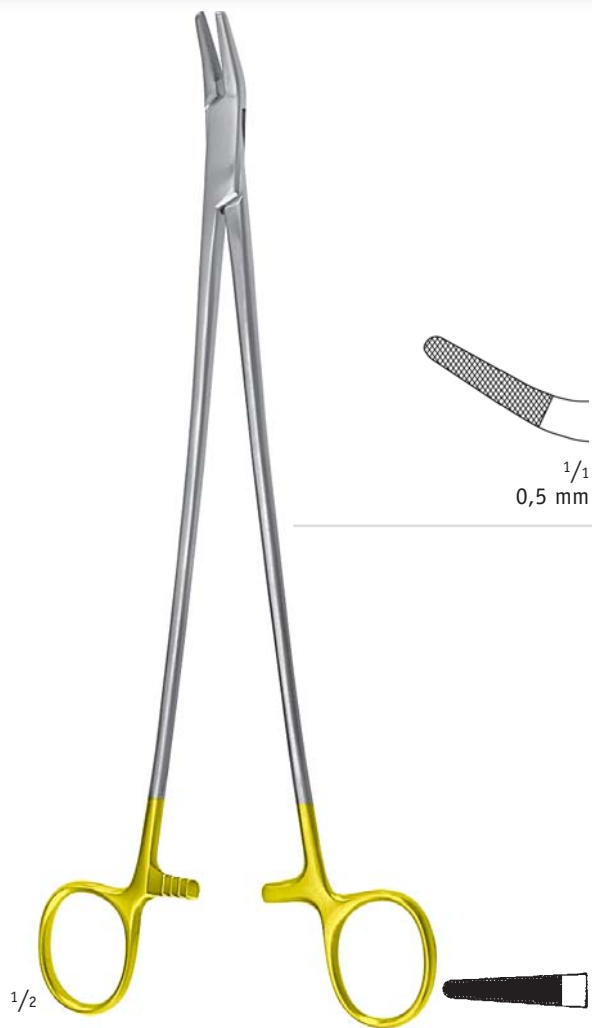

FINOCHIETTO

 Artikel-Nr.
 Cat. No.

 Gesamtlänge
 Total length

02-13-092

265 mm / 10¹/₂"

TC



SAROT

02-13-020







175 mm / 7"



SAROT

02-13-023

260 mm / 10¹/₄"

Artikel-Nr. Cat. No.	Gesamtlänge Total length			
02-13-186	180 mm / 7"	TOENNIS	 1/1 0,5 mm	 1/2
TC				
02-13-149	140 mm / 5 1/2"	MATHIEU	 1/1 0,5 mm	 1/2
02-13-151	170 mm / 6 3/4"	MATHIEU	 1/1 0,5 mm	
02-13-154	200 mm / 8"	MATHIEU	 1/1 0,5 mm	
02-63-155	240 mm / 9 1/2"	MATHIEU	 1/1 0,5 mm	

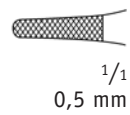

MATHIEU

 Artikel-Nr.
 Cat. No.

02-13-148

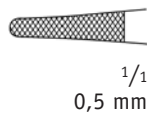
 Gesamtlänge
 Total length
140 mm / 5¹/₂"
 Schlankes Modell
 Delicate pattern · Modèle délicat
 Modelo delgado · Modello fino

MATHIEU

02-13-150

170 mm / 6³/₄"
 Schlankes Modell
 Delicate pattern · Modèle délicat
 Modelo delgado · Modello fino

MATHIEU

02-13-153

200 mm / 7³/₄"
 Schlankes Modell
 Delicate pattern · Modèle délicat
 Modelo delgado · Modello fino

TC

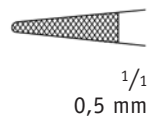

LICHTENBERG

02-13-132

195 mm / 7³/₄"

1/2

Artikel-Nr. Cat. No.	Gesamtlänge Total length				
02-63-124	120 mm / 4 ³ / ₄ " glattes Maul smooth jaw mors lisse boca lisa morso piatto	OLSEN HEGAR	 1/1		1/2
02-63-125	120 mm / 4 ³ / ₄ "	OLSEN HEGAR	 1/1		
02-63-126	120 mm / 4 ³ / ₄ "	OLSEN HEGAR	 1/1 0,3 mm		1/2
02-13-127	120 mm / 4 ³ / ₄ " glattes Maul smooth jaw mors lisse boca lisa morso piatto	OLSEN HEGAR	 1/1		
TC					
02-13-299	160 mm / 6 ¹ / ₄ "	GILLIES	  1/1		1/2
02-13-129	160 mm / 6 ¹ / ₄ "	GILLIES	  1/1 0,5 mm		
TC					

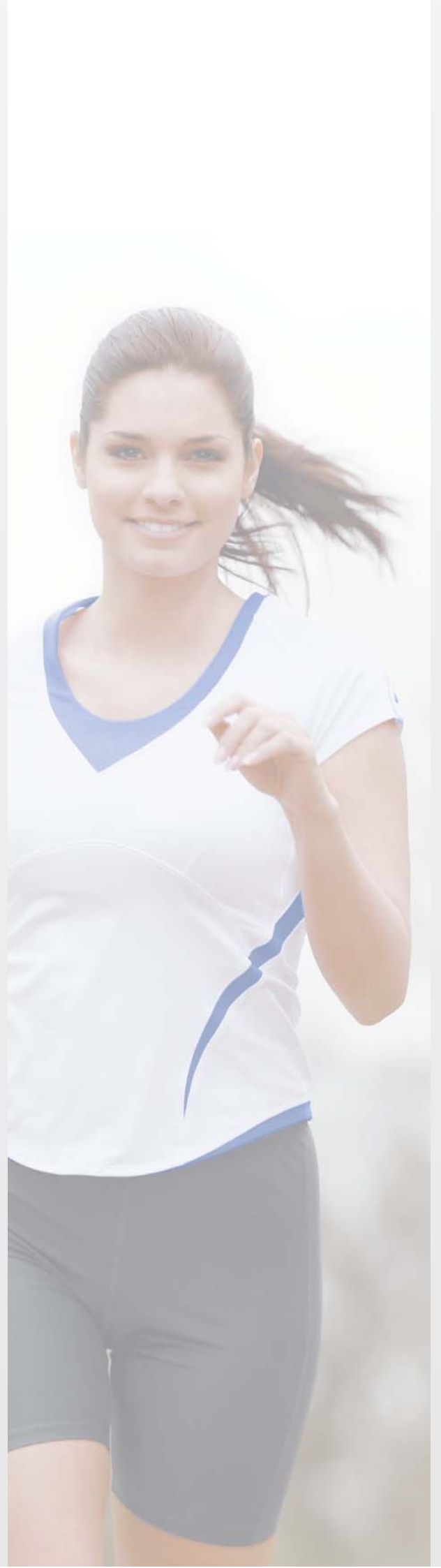

Bulldogklemmen, Gefäßclips
Bulldog Clamps, Vessel Clips · Clamps Bulldog, Clips vasculaires
Clamps Bulldog, Clips vasculares · Pinze Bulldog, Clips vascolari

// 01

Atraumatische Gefäßklemmen
Atraumatic Vascular Clamps · Pincés vasculaires atraumatiques
Pinzas vasculares atraumáticas · Pinze vascolari atraumatiche

// 02

Atraumatische Pinzetten
Atraumatic Tissue Forceps · Pincés atraumatiques
Pinzas atraumáticas · Pinze atraumatiche

// 03

Rippensperrer
Rib Spreaders · Ecarteurs pour costaux
Separadores costales · Divaricatori costali

// 04

Atrium, Aorta-Instrumente
Atrium-, Aortic Instruments · Instruments pour l'oreillette et l'aorte
Instrumentos para el atrium y la aorta · Strumenti per atrio e aorta

// 05

Wundhaken, Wundspreizer
Retractors · Ecarteurs
Separadores · Divaricatori

// 06

Sonden, Dilatationsinstrumente
Probes, Instruments for dilatation · Sondes, Instruments pour la dilatation
Sondas, Instrumentos para la dilatación · Sonda, Strumenti a dilatazione

// 07

Mikro-Instrumente
Micro Instruments · Micro instruments
Instrumentos para microcirugía · strumenti per microchirurgia

// 08

Allgemeinchirurgische Instrumente
General surgery instruments · Instruments pour la chirurgie générale
Instrumentos para la cirugía general · Strumenti per chirurgia generale

// 09

Orthopädische Instrumente
Orthopaedic Instruments · Instruments pour l'orthopédie
Instrumentos para ortopedia · Strumenti per ortopedia

// 10







1/2

 Artikel-Nr.
 Cat. No.

 Gesamtlänge
 Total length

01-51-631

190 mm / 7¹/₂"

1/2

01-01-632

230 mm / 9¹/₄"

Artikel-Nr.
 Cat. No.

Gesamtlänge
 Total length

06-02-870

220 mm / 8³/₄"



1/2

06-02-911

210 mm / 8¹/₄"

SCHUMACHER

Sternumschere
 Sternum scissors · Ciseaux à sternum
 Tijera de esternón · Forbici per sterno



1/2



1/3

 Artikel-Nr.
 Cat. No.

 Gesamtlänge
 Total length
GLUCK**06-02-873**220 mm / 8³/₄"
 Rippenschere mit ziehendem Schnitt
 Rib Shears with drawing cut
 Costotome avec lame excentrée
 Costótomo con haja de retroacción
 Costotomo con lama eccentrica a scorrimento

1/3

COLLIN**06-02-872**195 mm / 7³/₄"

1/3

STILLE**06-52-871**210 mm / 8¹/₄"

Artikel-Nr.
Cat. No.

Gesamtlänge
Total length

06-52-874

350 mm / 14"

CORYLLOS

links
left · gauche · izquierda · sinistro



06-52-875

350 mm / 14"

CORYLLOS

rechts
right · droite · derecha · destro





1/3

BETHUNE
 Artikel-Nr.
 Cat. No.
06-02-878
 Gesamtlänge
 Total length
340 mm / 13¹/₂"

1/3

COOLEY**06-52-876**

350 mm / 14"

Artikel-Nr.
Cat. No.

Gesamtlänge
Total length

06-52-877

250 mm / 10"

LEBSCHÉ



06-02-882

260 mm / 10¹/₄"

SAUERBRUCH



**SAUER-
BRUCH-
FREY**

 Artikel-Nr.
 Cat. No.

06-02-883

 Gesamtlänge
 Total length

360 mm / 14"

 für die erste Rippe
 for the first rib · pour la première côte
 para la primera costilla · per la prima costola

1/3

BRUNNER
06-02-892

320 mm / 12½"

 für die rechte Hand
 for right hand · pour la main droite
 para la mano derecha · per la mano destra

06-52-893

320 mm / 12½"

 für die linke Hand
 for left hand · pour la main gauche
 para la mano izquierda · per la mano sinistra

1/3

Artikel-Nr.
Cat. No.

Gesamtlänge
Total length











06-02-890

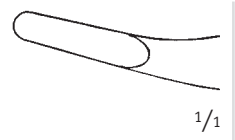



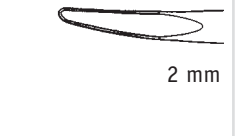

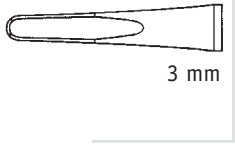

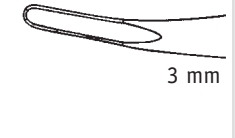
270 mm / 10¹/₂"





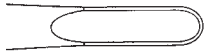

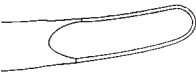

GIERTZ-
STILLE

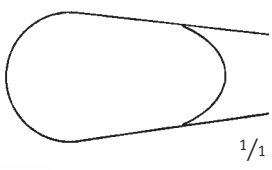

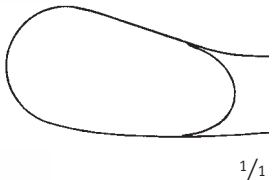

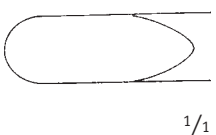

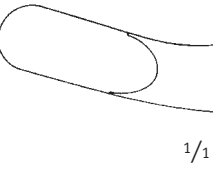

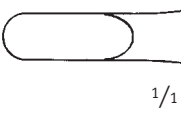

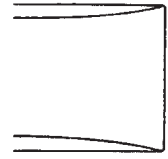
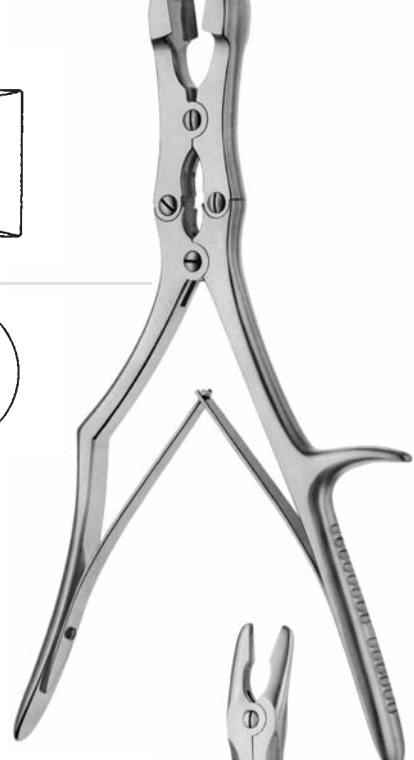
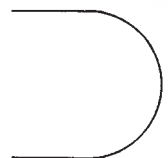
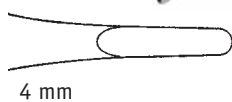

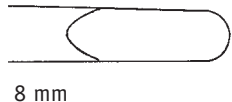
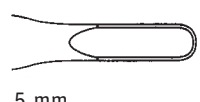
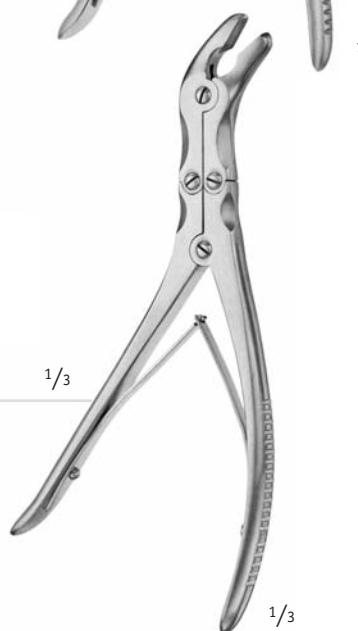
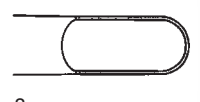

1/3

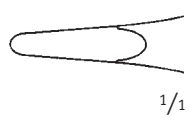

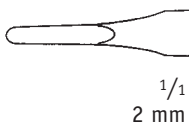

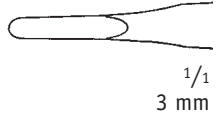

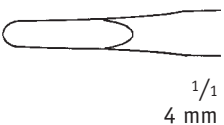

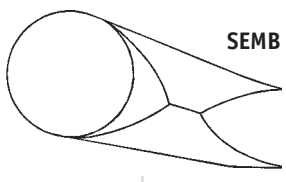
 1/3	 1/1	BEYER	Artikel-Nr. <i>Cat. No.</i> 06-15-514	Gesamtlänge <i>Total length</i> 180 mm / 7"
 1/3	 1/1	ZAUFAL JANSEN	06-15-515	180 mm / 7"
 1/3	 1,7 mm	BOEHLER	06-65-500	150 mm / 5 ³ / ₄ "
 1/3	 2 mm	BOEHLER	06-65-501	150 mm / 5 ³ / ₄ "
 1/3	 2 mm	BOEHLER	06-15-500	150 mm / 5 ³ / ₄ "
 1/3	 3 mm	BOEHLER	06-65-502	150 mm / 5 ³ / ₄ "
 1/3	 3 mm	BOEHLER	06-15-502	150 mm / 5 ³ / ₄ "

Artikel-Nr. Cat. No.	Gesamtlänge Total length	MARQUARDT	 1/1		1/3
06-15-520	200 mm / 8"	MARQUARDT	 1/1		1/3
06-65-517	240 mm / 9 1/2"	RUSKIN	 1/1		1/3
06-15-521	240 mm / 9 1/2"	RUSKIN	 1/1		1/3





		Artikel-Nr. Cat. No.	Gesamtlänge Total length
	 1/1	STILLE LUER 06-65-553	230 mm / 9"
		06-65-554	270 mm / 10 ¹ / ₂ "
	 1/1	STILLE LUER 06-65-556	230 mm / 9"
		06-15-566	270 mm / 10 ¹ / ₂ "
 1/3	 1/1	STILLE LUER 06-15-550	220 mm / 8 ³ / ₄ "
 1/3	 1/1	STILLE LUER 06-15-551	220 mm / 8 ³ / ₄ "
 1/3	 1/1	STILLE LUER 06-15-530	230 mm / 9"

Artikel-Nr. Cat. No.	Gesamtlänge Total length			
06-15-572	310 mm / 12 ¹ / ₄ "	SAUER- BRUCH	 1/1	
06-15-570	310 mm / 12 ¹ / ₄ "	SAUER- BRUCH	 1/1	
06-65-531	245 mm / 9 ³ / ₄ "	LEKSELL- STILLE	 4 mm	
06-15-532	245 mm / 9 ³ / ₄ "	LEKSELL- STILLE	 8 mm	
06-65-536	230 mm / 9"	LEKSELL	 5 mm	
06-65-537	230 mm / 9"	LEKSELL	 8 mm	



			Artikel-Nr. Cat. No.	Gesamtlänge Total length
 <p>1/3</p>	 <p>1/1</p>	FRYKHOLM	06-15-525	240 mm / 9 1/2"
 <p>1/3</p>	 <p>1/1 2 mm</p>	ECHLIN	06-15-522	230 mm / 9"
 <p>1/3</p>	 <p>1/1 3 mm</p>	ECHLIN	06-15-523	230 mm / 9"
 <p>1/3</p>	 <p>1/1 4 mm</p>	ECHLIN	06-65-524	230 mm / 9"
 <p>1/3</p>	 <p>1/1</p>	SEMB	06-15-555	225 mm / 9"





Artikel-Nr. Cat. No.	Gesamtlänge Total length			
06-65-510	240 mm / 9 ¹ / ₂ "	SMITH PETERSEN	 1/1 3 mm	 1/3
06-65-511	240 mm / 9 ¹ / ₂ "	SMITH PETERSEN	 1/1 3 mm	
06-65-512	240 mm / 9 ¹ / ₂ "	SMITH PETERSEN	 1/1 3 mm	
06-15-601	150 mm / 5 ³ / ₄ "		 1/1	 1/3
06-15-602	170 mm / 6 ³ / ₄ "		 1/1	 1/3

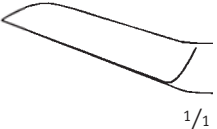
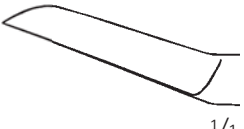



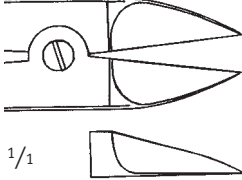
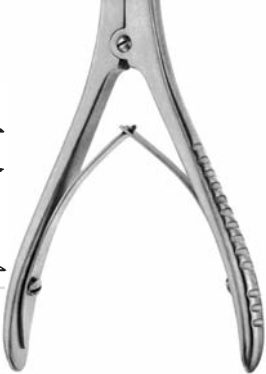
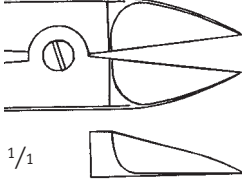
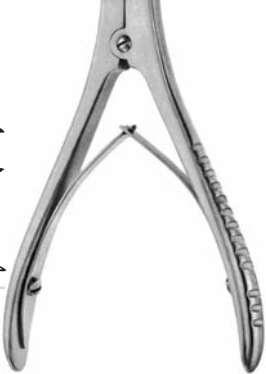
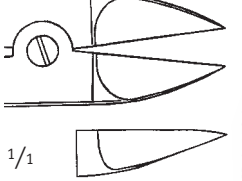

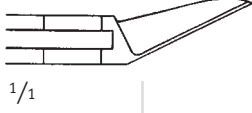

		Artikel-Nr. Cat. No.	Gesamtlänge Total length
	LISTON	06-15-620	140 mm / 5 ¹ / ₂ "
	LISTON	06-15-622	170 mm / 6 ³ / ₄ "
	LISTON	06-15-624	200 mm / 8"
	LISTON	06-15-626	220 mm / 8 ³ / ₄ "

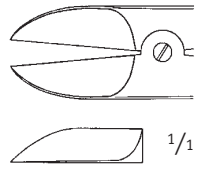

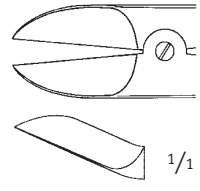
	LISTON	06-15-631	140 mm / 5 ¹ / ₂ "
	LISTON	06-15-632	170 mm / 6 ³ / ₄ "
	LISTON	06-15-634	200 mm / 8"
	LISTON	06-15-636	220 mm / 8 ³ / ₄ "

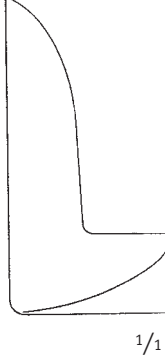
Artikel-Nr. Cat. No.	Gesamtlänge Total length	BOEHLER	 1/1	 1/2
06-15-610	150 mm / 5 ³ / ₄ "	BOEHLER	 1/1	 1/2
06-15-611	150 mm / 5 ³ / ₄ "	BOEHLER	 1/1	 1/2
06-15-614	190 mm / 7 ¹ / ₂ "	MCINDOE	 1/1	 1/2

		Artikel-Nr. Cat. No.	Gesamtlänge Total length
		RUSKIN LISTON 06-15-640	180 mm / 7"
$\frac{1}{3}$			
		RUSKIN LISTON 06-15-641	180 mm / 7"
$\frac{1}{3}$			
		STILLE LISTON 06-15-648	265 mm / 10 $\frac{3}{4}$ "
$\frac{1}{3}$			
		STILLE LISTON 06-15-646	275 mm / 10 $\frac{3}{4}$ "
$\frac{1}{3}$			

Artikel-Nr. Cat. No.	Gesamtlänge Total length	STILLE LISTON	1/1	1/3
06-15-645	235 mm / 9 ¹ / ₄ "	STILLE LISTON	1/1	1/3
06-15-647	275 mm / 10 ³ / ₄ "	STILLE LISTON	1/1	1/3
06-15-649	270 mm / 10 ¹ / ₂ "	STILLE HORSLEY	1/1	1/3
06-65-650	240 mm / 9 ¹ / ₂ "	SEMB	1/1	1/3



1/3

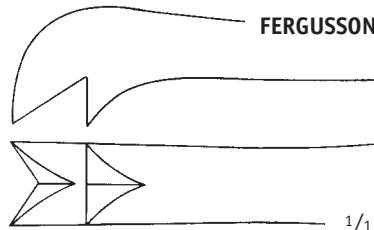

1/1

 Artikel-Nr.
 Cat. No.

06-15-130

 Gesamtlänge
 Total length
210 mm / 8¹/₄"
 kräftiges Modell
 heavy pattern
 modèle fort
 modelo fuerte
 modello forte

1/3

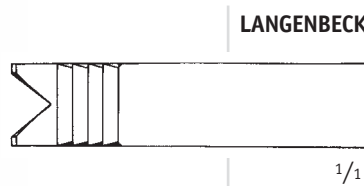

1/1

LANGENBECK

06-15-127

210 mm / 8¹/₄"

1/3

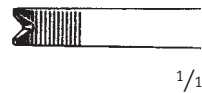

1/1

06-15-120

200 mm / 8"

Artikel-Nr.
 Cat. No.

Gesamtlänge
 Total length

06-15-136

190 mm / 7½"

SEMB

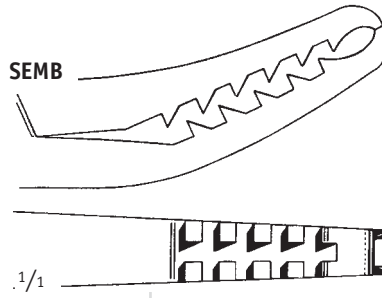

1/1



1/2

06-15-135

190 mm / 7½"

SEMB

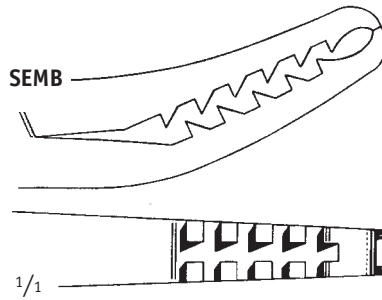







1/1



1/2



		Artikel-Nr. Cat. No.	Gesamtlänge Total length
	SCHUDE	06-11-621	170 mm / 6 ³ / ₄ " Fig. 000 oval, mit Hohlheft oval, with hollow handle · ovale, avec manche creux ovalada, con mango hueco · ovala, con manico vuoto
	SCHUDE	06-11-622	170 mm / 6 ³ / ₄ " Fig. 00 oval, mit Hohlheft oval, with hollow handle · ovale, avec manche creux ovalada, con mango hueco · ovala, con manico vuoto
	SCHUDE	06-11-623	170 mm / 6 ³ / ₄ " Fig. 0 oval, mit Hohlheft oval, with hollow handle · ovale, avec manche creux ovalada, con mango hueco · ovala, con manico vuoto
	SCHUDE	06-11-624	170 mm / 6 ³ / ₄ " Fig. 1 oval, mit Hohlheft oval, with hollow handle · ovale, avec manche creux ovalada, con mango hueco · ovala, con manico vuoto
	SCHUDE	06-11-625	170 mm / 6 ³ / ₄ " Fig. 2 oval, mit Hohlheft oval, with hollow handle · ovale, avec manche creux ovalada, con mango hueco · ovala, con manico vuoto
	SCHUDE	06-11-626	170 mm / 6 ³ / ₄ " Fig. 3 oval, mit Hohlheft oval, with hollow handle · ovale, avec manche creux ovalada, con mango hueco · ovala, con manico vuoto
	SCHUDE	06-11-627	170 mm / 6 ³ / ₄ " Fig. 4 oval, mit Hohlheft oval, with hollow handle · ovale, avec manche creux ovalada, con mango hueco · ovala, con manico vuoto











1/1





Artikel-Nr. Cat. No.	Gesamtlänge Total length	BRUNS	
06-61-610	170 mm / 6 ³ / ₄ " Fig. 0000 rund, mit Hohlheft round, with hollow handle · rond, avec manche creux redonda, con mango hueco · rotonda, con manico vuoto	BRUNS	○ 1/1 2 mm
06-11-611	170 mm / 6 ³ / ₄ " Fig. 000 rund, mit Hohlheft round, with hollow handle · rond, avec manche creux redonda, con mango hueco · rotonda, con manico vuoto	BRUNS	○ 1/1 3 mm
06-11-612	170 mm / 6 ³ / ₄ " Fig. 00 rund, mit Hohlheft round, with hollow handle · rond, avec manche creux redonda, con mango hueco · rotonda, con manico vuoto	BRUNS	○ 1/1 4 mm
06-11-613	170 mm / 6 ³ / ₄ " Fig. 0 rund, mit Hohlheft round, with hollow handle · rond, avec manche creux redonda, con mango hueco · rotonda, con manico vuoto	BRUNS	○ 1/1 5 mm
06-11-614	170 mm / 6 ³ / ₄ " Fig. 1 rund, mit Hohlheft round, with hollow handle · rond, avec manche creux redonda, con mango hueco · rotonda, con manico vuoto	BRUNS	○ 1/1 6 mm
06-11-615	170 mm / 6 ³ / ₄ " Fig. 2 rund, mit Hohlheft round, with hollow handle · rond, avec manche creux redonda, con mango hueco · rotonda, con manico vuoto	BRUNS	○ 1/1 8 mm
06-11-616	170 mm / 6 ³ / ₄ " Fig. 3 rund, mit Hohlheft round, with hollow handle · rond, avec manche creux redonda, con mango hueco · rotonda, con manico vuoto	BRUNS	○ 1/1 10 mm
06-11-617	170 mm / 6 ³ / ₄ " Fig. 4 rund, mit Hohlheft round, with hollow handle · rond, avec manche creux redonda, con mango hueco · rotonda, con manico vuoto	BRUNS	○ 1/1 12 mm
06-61-618	170 mm / 6 ³ / ₄ " Fig. 5 rund, mit Hohlheft round, with hollow handle · rond, avec manche creux redonda, con mango hueco · rotonda, con manico vuoto	BRUNS	○ 1/1 14 mm
06-61-619	170 mm / 6 ³ / ₄ " Fig. 6 rund, mit Hohlheft round, with hollow handle · rond, avec manche creux redonda, con mango hueco · rotonda, con manico vuoto	BRUNS	○ 1/1 16 mm





1/1

		Artikel-Nr. Cat. No.	Gesamtlänge Total length
	VOLKMANN	06-11-630	170 mm / 6 ³ / ₄ " Fig. 0000 oval, mit Hohlheft oval, with hollow handle · ovale, avec manche creux ovalada, con mango hueco · ovala, con manico vuoto
1/1 2,8 mm			
	VOLKMANN	06-11-631	170 mm / 6 ³ / ₄ " Fig. 000 oval, mit Hohlheft oval, with hollow handle · ovale, avec manche creux ovalada, con mango hueco · ovala, con manico vuoto
1/1 3,6 mm			
	VOLKMANN	06-11-632	170 mm / 6 ³ / ₄ " Fig. 00 oval, mit Hohlheft oval, with hollow handle · ovale, avec manche creux ovalada, con mango hueco · ovala, con manico vuoto
1/1 4,4 mm			
	VOLKMANN	06-11-633	170 mm / 6 ³ / ₄ " Fig. 0 oval, mit Hohlheft oval, with hollow handle · ovale, avec manche creux ovalada, con mango hueco · ovala, con manico vuoto
1/1 5,2 mm			
	VOLKMANN	06-11-634	170 mm / 6 ³ / ₄ " Fig. 1 oval, mit Hohlheft oval, with hollow handle · ovale, avec manche creux ovalada, con mango hueco · ovala, con manico vuoto
1/1 6,8 mm			
	VOLKMANN	06-11-635	170 mm / 6 ³ / ₄ " Fig. 2 oval, mit Hohlheft oval, with hollow handle · ovale, avec manche creux ovalada, con mango hueco · ovala, con manico vuoto
1/1 8,5 mm			
	VOLKMANN	06-11-636	170 mm / 6 ³ / ₄ " Fig. 3 oval, mit Hohlheft oval, with hollow handle · ovale, avec manche creux ovalada, con mango hueco · ovala, con manico vuoto
1/1 10 mm			
	VOLKMANN	06-11-637	170 mm / 6 ³ / ₄ " Fig. 4 oval, mit Hohlheft oval, with hollow handle · ovale, avec manche creux ovalada, con mango hueco · ovala, con manico vuoto
1/1 11,5 mm			
	VOLKMANN	06-11-638	170 mm / 6 ³ / ₄ " Fig. 5 oval, mit Hohlheft oval, with hollow handle · ovale, avec manche creux ovalada, con mango hueco · ovala, con manico vuoto
1/1 13 mm			
	VOLKMANN	06-11-639	170 mm / 6 ³ / ₄ " Fig. 6 oval, mit Hohlheft oval, with hollow handle · ovale, avec manche creux ovalada, con mango hueco · ovala, con manico vuoto
1/1 14,5 mm			

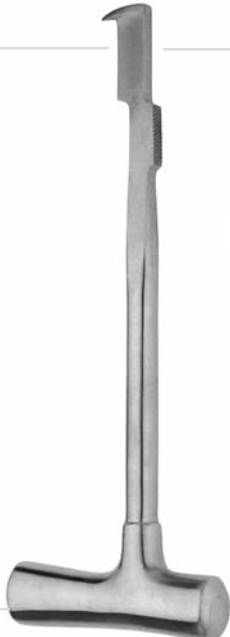
Artikel-Nr. Cat. No.	Gesamtlänge Total length		
06-62-710	265 mm / 10 ¹ / ₂ " Kopf <i>head · tête · cabeza · testa</i> Ø 35 mm Gewicht <i>weight · poids · peso · peso</i> 450 g		
06-62-711	265 mm / 10 ¹ / ₂ " Kopf <i>head · tête · cabeza · testa</i> Ø 50 mm Gewicht <i>weight · poids · peso · peso</i> 900 g		
06-62-712	265 mm / 10 ¹ / ₂ " Kopf <i>head · tête · cabeza · testa</i> Ø 55 mm Gewicht <i>weight · poids · peso · peso</i> 1300 g		
06-12-036	185 mm / 7 ¹ / ₂ " Kopf <i>head · tête · cabeza · testa</i> Ø 25 mm Gewicht <i>weight · poids · peso · peso</i> 135 g		
06-12-037	Ersatzbacken zu 06-12-036, Paar <i>Spare facings to 06-12-036, pair</i> <i>Joues de rechange pour 06-12-036, paire</i> <i>Frentes de repuesto para 06-12-036, par</i> <i>Guancie di ricambio per 06-12-036, paio</i>		
06-02-918	245 mm / 9 ³ / ₄ " Sternnummeißel <i>Sternum Chisel · Ciseau-burin à sternum</i> <i>Cinzel para esternón · Scalpello per sterno</i>	LEBSCHE	



1/2

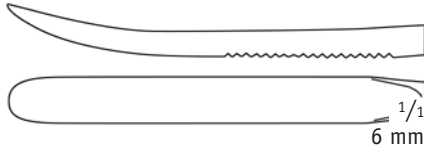

Artikel-Nr.
Cat. No.

Gesamtlänge
Total length

06-11-301

165 mm / 6 1/2"

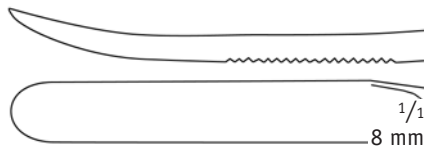

06-11-302

165 mm / 6 1/2"



1/2

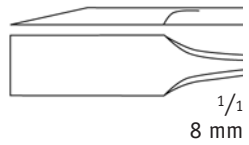

ADSON

06-11-306

170 mm / 6 3/4"

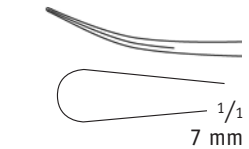

ADSON

06-11-307

170 mm / 6 3/4"

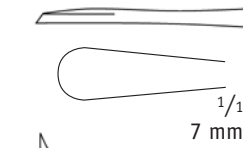

ADSON

06-11-308



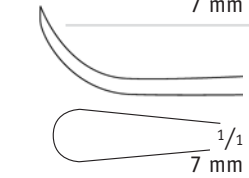



170 mm / 6 3/4"







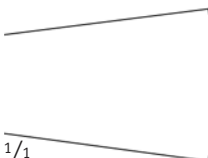
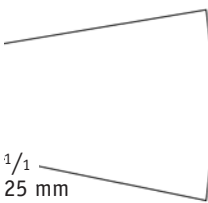
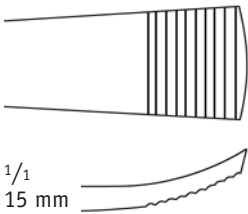

ADSON

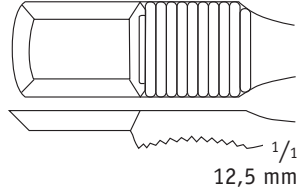
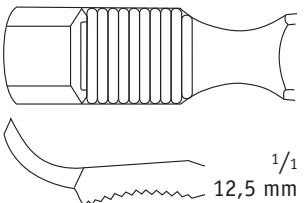
06-11-309

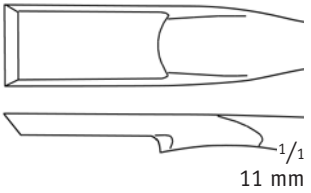
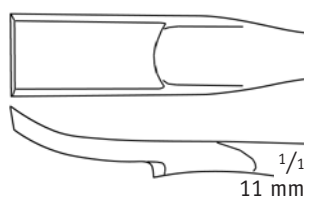
170 mm / 6 3/4"

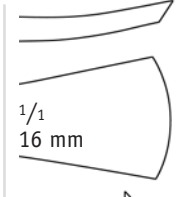
Artikel-Nr. Cat. No.	Gesamtlänge Total length			
06-11-355	215 mm / 8 ¹ / ₂ "	LAMBOTTE	 1/1 5 mm	 1/2
06-11-356	215 mm / 8 ¹ / ₂ "	LAMBOTTE	 1/1 10 mm	
06-11-357	215 mm / 8 ¹ / ₂ "	LAMBOTTE	 1/1 15 mm	
06-11-358	215 mm / 8 ¹ / ₂ "	LAMBOTTE	 1/1 20 mm	
06-11-359	215 mm / 8 ¹ / ₂ "	LAMBOTTE	 1/1 25 mm	
06-11-362	165 mm / 6 ¹ / ₂ "	JANSEN	 1/1 15 mm	 1/2

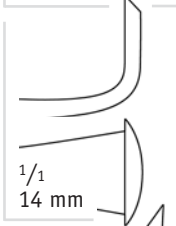
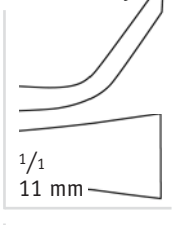
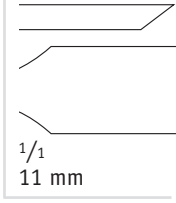
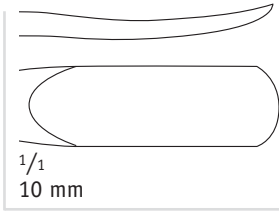
 1/2	 12,5 mm 1/1	FARABEU	06-11-340	Gesamtlänge Total length 140 mm / 5 1/2"
	 12,5 mm 1/1	FARABEU	06-11-341	140 mm / 5 1/2"
 1/2	 11 mm 1/1	FARABEU- COLLIN	06-11-344	160 mm / 6 1/4"
	 11 mm 1/1	FARABEU- COLLIN	06-11-345	160 mm / 6 1/4"

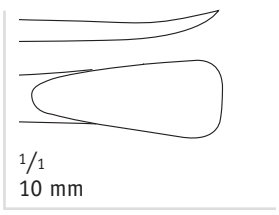
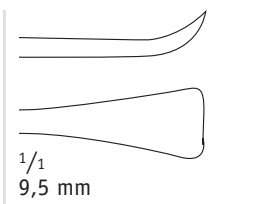
Artikel-Nr. Cat. No.	Gesamtlänge Total length			
06-11-360	190 mm / 7 ¹ / ₂ "	LANGEN- BECK		
06-11-361	180 mm / 7"	LANGEN- BECK		
06-61-380	190 mm / 7"	LANGEN- BECK		
06-11-379	195 mm / 7 ³ / ₄ "	MC KISSOCK		
06-11-390	185 mm / 7 ¹ / ₄ "	KRÄMER		
06-11-391	190 mm / 7 ¹ / ₂ "	KRÄMER		
04-15-518	190 mm / 7 ¹ / ₂ "	BÜCHS		



1/2

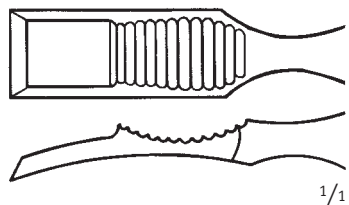

1/1

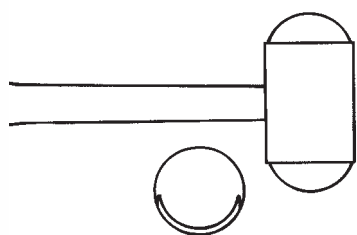

ALEXANDER

 Artikel-Nr.
 Cat. No.

 Gesamtlänge
 Total length

06-61-419

160 mm / 6¹/₄"

06-11-420

200 mm / 7³/₄"

1/2

 MATSON
 ALEXANDER

06-61-420

220 mm / 8³/₄"

Artikel-Nr.
 Cat. No.

Gesamtlänge
 Total length

06-61-421

220 mm / 8³/₄"

MATSON

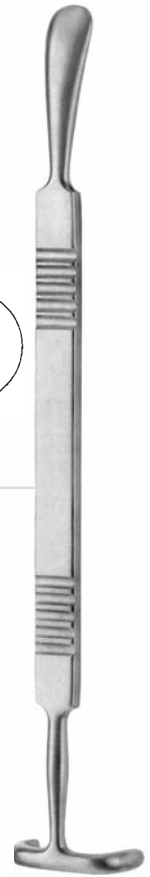
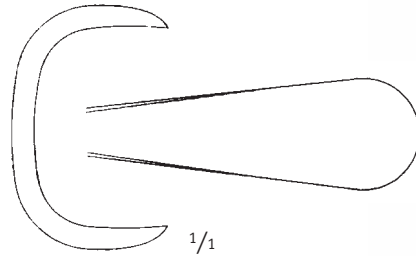

1/2

06-61-422

295 mm / 11³/₄"

OVERHOLT



1/2

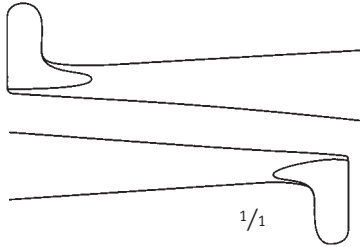

1/3

**OVERHOLT**
 Artikel-Nr.
 Cat. No.
06-61-423
 Gesamtlänge
 Total length
295 mm / 11³/₄"

1/3

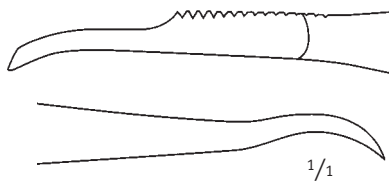
**OVERHOLT****06-61-424**285 mm / 11¹/₄"

Artikel-Nr.
 Cat. No.

Gesamtlänge
 Total length

06-11-400

170 mm / 6³/₄"

rechts gebogen, mit Hohlheft, für Kinder
right curved, with hollow handle, for children
courbe à droite, avec manche creux, pour enfants
curvo a la derecha, con mango hueco, para niños
curvo destro, con manico vuoto, per bambini

DOYEN



1/2

06-11-401

170 mm / 6³/₄"

links gebogen, mit Hohlheft, für Kinder
left curved, with hollow handle, for children
courbe à gauche, avec manche creux, pour enfants
curvo a la izquierda, con mango hueco, para niños
curvo sinistro, con manico vuoto, per bambini

DOYEN



1/2



DOYEN

 Artikel-Nr.
 Cat. No.

06-11-402

 Gesamtlänge
 Total length
170 mm / 6³/₄"

rechts gebogen, mit Hohlheft, für Erwachsene
 right curved, with hollow handle, for adults
 courbe à droite, avec manche creux, pour adultes
 curvo a la derecha, con mango hueco, para adultos
 curvo destro, con manico vuoto, per adulti



DOYEN

06-11-403

170 mm / 6³/₄"

links gebogen, mit Hohlheft, für Erwachsene
 left curved, with hollow handle, for adults
 courbe à gauche, avec manche creux, pour adultes
 curvo a la izquierda, con mango hueco, para adultos
 curvo sinistro, con manico vuoto, per adulti

Artikel-Nr.
Cat. No.

Gesamtlänge
Total length

06-11-408

240 mm / 9¹/₂"

DOYEN

rechts gebogen, mit Hohlheft, für Erwachsene
right curved, with hollow handle, for adults
courbe à droite, avec manche creux, pour adultes
curvo a la derecha, con mango hueco, para adultos
curvo destro, con manico vuoto, per adulti

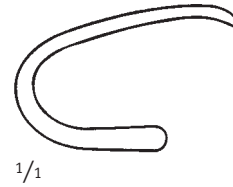

06-11-409

240 mm / 9¹/₂"

DOYEN

links gebogen, mit Hohlheft, für Erwachsene
left curved, with hollow handle, for adults
courbe à gauche, avec manche creux, pour adultes
curvo a la izquierda, con mango hueco, para adultos
curvo sinistro, con manico vuoto, per adulti

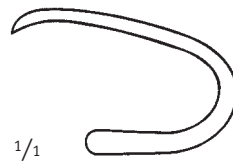

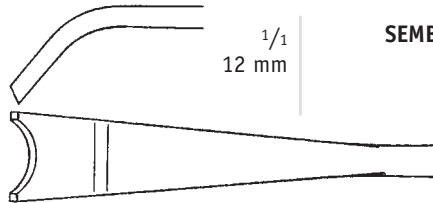
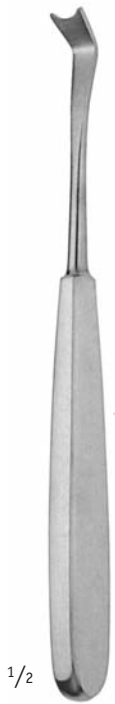

SEMB

Artikel-Nr.
Cat. No.

06-11-381

Gesamtlänge
Total length

185 mm / 7¹/₄"

1/2

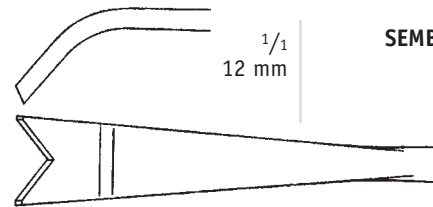

SEMB

06-11-382

215 mm / 8¹/₂"

1/2

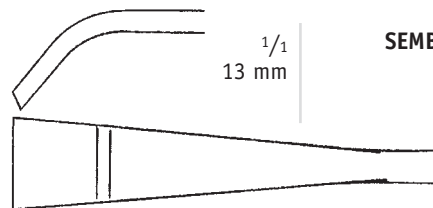

SEMB

06-11-383

185 mm / 7¹/₄"

1/2

Artikel-Nr.
 Cat. No.

Gesamtlänge
 Total length

06-11-384

215 mm / 8¹/₄"

SEMB

1/1
 13 mm

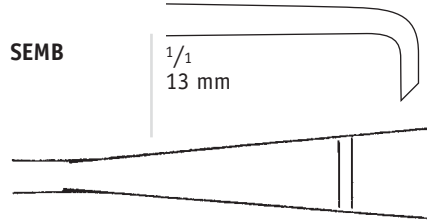

1/2

06-11-387

210 mm / 8¹/₄"

SEMB

1/1
 15 mm

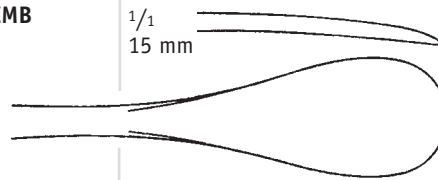

1/2

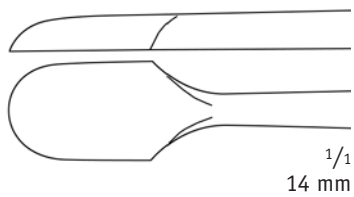

 $\frac{1}{1}$
 14 mm

 Artikel-Nr.
 Cat. No.

 Gesamtlänge
 Total length

06-61-326

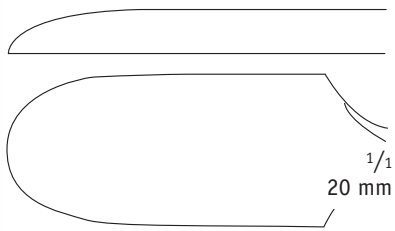
205 mm / 8"

 mit Ferrozellgriff
 with handle from artificial wood
 avec manche de Ferrozell
 con mango de madera artificial
 con manico in lengo artificiale

 $\frac{1}{1}$
 20 mm

06-61-327

205 mm / 8"

 mit Ferrozellgriff
 with handle from artificial wood
 avec manche de Ferrozell
 con mango de madera artificial
 con manico in lengo artificiale

 $\frac{2}{3}$

Artikel-Nr. Cat. No.	Gesamtlänge Total length			
06-11-317	185 mm / 7 ¹ / ₄ " mit Ferrozellgriff with handle from artificial wood avec manche de Ferrozell con mango de madera artificial con manico in lengo artificiale		1/1 3 mm	
06-11-318	190 mm / 7 ¹ / ₂ " mit Ferrozellgriff with handle from artificial wood avec manche de Ferrozell con mango de madera artificial con manico in lengo artificiale		1/1 6 mm	
06-11-319	190 mm / 7 ¹ / ₂ " mit Ferrozellgriff with handle from artificial wood avec manche de Ferrozell con mango de madera artificial con manico in lengo artificiale		1/1 6 mm	
06-11-321	190 mm / 7 ¹ / ₂ " mit Ferrozellgriff with handle from artificial wood avec manche de Ferrozell con mango de madera artificial con manico in lengo artificiale		1/1 6 mm	
06-11-323	185 mm / 7 ¹ / ₄ " mit Ferrozellgriff with handle from artificial wood avec manche de Ferrozell con mango de madera artificial con manico in lengo artificiale		1/1 13 mm	
06-11-324	195 mm / 7 ³ / ₄ " mit Ferrozellgriff with handle from artificial wood avec manche de Ferrozell con mango de madera artificial con manico in lengo artificiale		1/1 14 mm	
06-11-325	190 mm / 7 ¹ / ₂ " mit Ferrozellgriff with handle from artificial wood avec manche de Ferrozell con mango de madera artificial con manico in lengo artificiale		1/1 14 mm	

1/2

1/2

 Artikel-Nr.
 Cat. No.

11-25-002	∅ 0,2 mm
11-25-003	∅ 0,3 mm
11-25-004	∅ 0,4 mm
11-25-005	∅ 0,5 mm
11-25-006	∅ 0,6 mm
11-25-007	∅ 0,7 mm
11-25-008	∅ 0,8 mm
11-25-009	∅ 0,9 mm
11-25-010	∅ 1,0 mm
11-25-012	∅ 1,2 mm
11-25-015	∅ 1,5 mm

weich, Rolle mit 10 m
 soft, coil of 10 m
 malléable, en rouleau de 10 m
 blando, rollo de 10 m
 molle, rotolo di 10 m

 Artikel-Nr.
 Cat. No.

 Gesamtlänge
 Total length

12-74-161	180 mm / 7"	parallel fassend <i>parallel grip · action parallèle</i> <i>acción paralela · afferramento parallelo</i>
12-74-162	180 mm / 7"	parallel fassend <i>parallel grip · action parallèle</i> <i>acción paralela · afferramento parallelo</i>
12-74-163	180 mm / 7"	parallel fassend <i>parallel grip · action parallèle</i> <i>acción paralela · afferramento parallelo</i>



1/1











1/1



1/1

1/2

Artikel-Nr. Cat. No.	Gesamtlänge Total length			
12-24-181	180 mm / 7"			
12-24-182	180 mm / 7"			
12-24-183	180 mm / 7"			
12-24-185	145 mm / 5 ³ / ₄ "			

12-74-170	180 mm / 7" parallel fassend parallel grip · action parallèle acción paralela · afferramento parallelo			
12-74-171	180 mm / 7" parallel fassend parallel grip · action parallèle acción paralela · afferramento parallelo			
12-74-172	180 mm / 7" parallel fassend parallel grip · action parallèle acción paralela · afferramento parallelo			
TC				

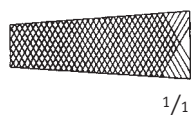

 Artikel-Nr.
 Cat. No.

 Gesamtlänge
 Total length

12-24-170

175 mm / 7"

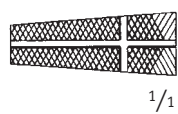
1/2



12-24-171

170 mm / 6³/₄"

1/2



04-16-031

140 mm / 5¹/₂"

1/2

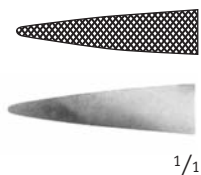

04-16-035

140 mm / 5¹/₂"

Artikel-Nr. Cat. No.	Gesamtlänge Total length
12-24-172	195 mm / 7 ³ / ₄ " Spitz- und Flachzange Flat Nose pliers, pointed · Pince plate, pointue Alicate plano, agudo · Tenaglie piatte, appuntate

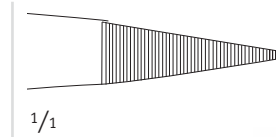

1/1



1/2

02-63-500	150 mm / 6" Automatic
------------------	--------------------------



1/1

02-63-501	150 mm / 6" Automatic
------------------	--------------------------



1/1

02-63-502	160 mm / 6 ¹ / ₄ " Automatic
------------------	---

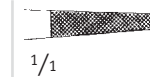

1/1

02-63-503	180 mm / 7" Automatic
------------------	--------------------------

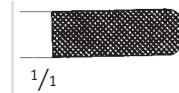









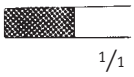

1/1



1/2

TC

		Artikel-Nr. Cat. No.	Gesamtlänge Total length
 <p>1/3</p>	 <p>1/1</p>	02-63-100	200 mm / 8"
 <p>1/3</p>		TC	
 <p>1/3</p>	 <p>1/1</p>	BAUM- GARTNER 02-13-112	200 mm / 8"

Artikel-Nr. Cat. No.	Gesamtlänge Total length			
02-13-111	155 mm / 6"		 1/1	 1/3
TC				
02-13-110	150 mm / 6"		 1/1	 1/3
TC				
02-13-113	190 mm / 7½"	BERRY	 1/1	 1/3
	kräftiges Modell heavy pattern · modèle fort modelo fuerte · modello forte			



1/2

HARVEY

 Artikel-Nr.
 Cat. No.

02-03-815

 Gesamtlänge
 Total length

125 mm / 5"



1/2

 Artikel-Nr.
 Cat. No.

04-16-551

 Artikel-Nr.
 Cat. No.

04-16-552

 Gesamtlänge
 Total length
120 mm / 4³/₄"
 Eine Schneide gezahnt
 One toothed cutting edge
 Une lame dentelée
 Una hoja dentada
 Una lama dentata

 für weiche Drähte bis
 for soft wires up to
 pour fils mous jusqu' à
 para alambres blandos hasta
 per fili molli fino a
ø 0,8 mm

 für harte Drähte bis
 for hard wires up to
 pour fils durs jusqu' à
 para alambres duros hasta
 per fili metallici duri fino a
ø 0,3 mm

1/3

TC

04-16-530

140 mm / 5¹/₂"
 für weiche Drähte bis
 for soft wires up to
 pour fils mous jusqu' à
 para alambres blandos hasta
 per fili molli fino a
ø 1,4 mm

 für harte Drähte bis
 for hard wires up to
 pour fils durs jusqu' à
 para alambres duros hasta
 per fili metallici duri fino a
ø 1,0 mm

Artikel-Nr. Cat. No.	Gesamtlänge Total length
12-24-159	180 mm / 7"
für weiche Drähte bis <i>for soft wires up to</i> <i>pour fils mous jusqu' à</i> <i>para alambres blandos hasta</i> <i>per fili molli fino a</i> ø 2,0 mm	
für harte Drähte bis <i>for hard wires up to</i> <i>pour fils durs jusqu' à</i> <i>para alambres duros hasta</i> <i>per fili metallici duri fino a</i> ø 1,7 mm	

REILL



1/1



1/2

TC

12-74-160	220 mm / 8 ³ / ₄ "
für weiche Drähte bis <i>for soft wires up to</i> <i>pour fils mous jusqu' à</i> <i>para alambres blandos hasta</i> <i>per fili molli fino a</i> ø 2,8 mm	
für harte Drähte bis <i>for hard wires up to</i> <i>pour fils durs jusqu' à</i> <i>para alambres duros hasta</i> <i>per fili metallici duri fino a</i> ø 2,2 mm	

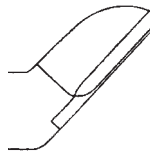

1/1



1/2

1/3		Artikel-Nr. Cat. No.	Gesamtlänge Total length
1/3		12-24-158	175 mm / 7" für weiche Drähte bis <i>for soft wires up to</i> <i>pour fils mous jusqu' à</i> <i>para alambres blandos hasta</i> <i>per fili molli fino a</i> ø 2,0 mm für harte Drähte bis <i>for hard wires up to</i> <i>pour fils durs jusqu' à</i> <i>para alambres duros hasta</i> <i>per fili metallici duri fino a</i> ø 1,5 mm
TC			
1/3		12-74-156	160 mm / 6 ¹ / ₄ " für weiche Drähte bis <i>for soft wires up to</i> <i>pour fils mous jusqu' à</i> <i>para alambres blandos hasta</i> <i>per fili molli fino a</i> ø 1,2 mm für harte Drähte bis <i>for hard wires up to</i> <i>pour fils durs jusqu' à</i> <i>para alambres duros hasta</i> <i>per fili metallici duri fino a</i> ø 1,6 mm
TC			
1/3		12-24-157	235 mm / 9 ¹ / ₄ " für weiche Drähte bis <i>for soft wires up to</i> <i>pour fils mous jusqu' à</i> <i>para alambres blandos hasta</i> <i>per fili molli fino a</i> ø 3,0 mm für harte Drähte bis <i>for hard wires up to</i> <i>pour fils durs jusqu' à</i> <i>para alambres duros hasta</i> <i>per fili metallici duri fino a</i> ø 2,2 mm

Artikel-Nr.
Cat. No.

Gesamtlänge
Total length

12-74-154

160 mm / 6¹/₄"

Kopfschneider
Wire Cutter, front action
Pince coupante frontale
Alicates frontal para cortar alambre
Tenaglie tagliafilì frontali

für weiche Drähte bis
for soft wires up to
pour fils mous jusqu' à
para alambres blandos hasta
per fili molli fino a
ø 2,2 mm

für harte Drähte bis
for hard wires up to
pour fils durs jusqu' à
para alambres duros hasta
per fili metallici duri fino a
ø 2,0 mm



1/2

12-74-155

185 mm / 7¹/₄"

für weiche Drähte bis
for soft wires up to
pour fils mous jusqu' à
para alambres blandos hasta
per fili molli fino a
ø 2,5 mm

für harte Drähte bis
for hard wires up to
pour fils durs jusqu' à
para alambres duros hasta
per fili metallici duri fino a
ø 1,5 mm



1/2

TC



Rebstock Instruments GmbH

In Weiheräcker 7

D-78589 Dürbheim/Tuttlingen · Germany

Tel. +49 (0) 74 24 / 67 34

Fax +49 (0) 74 24 / 43 34

info@rebstock.de

www.rebstock.de

REBSTOCK

Precision made in Germany



Cardiovascular

Inhaltsverzeichnis

Index

Indice

© Copyright by Rebstock Instruments GmbH. Alle Rechte vorbehalten. Nachdruck, auch auszugsweise, verboten. Kein Teil dieses Katalogs darf ohne schriftliche Genehmigung der Firma Rebstock Instruments GmbH in irgendeiner Form reproduziert oder unter Verwendung elektronischer Systeme verarbeitet, vervielfältigt oder verbreitet werden.

© Copyright by Rebstock Instruments GmbH. All rights reserved. Full or partial reproduction prohibited. No part of this catalogue may be reproduced, processed or transmitted in any form or manner, electronic or mechanical without written permission of Rebstock Instruments GmbH.

© Copyright by Rebstock Instruments GmbH. Tous droits réservés. La reproduction intégrale ou partielle est interdite. Aucune partie de ce catalogue ne doit pas être reproduite sous quelque forme et ne doit pas être traitée, copiée ou diffusée au moyen de systèmes électroniques sans l'autorisation de Rebstock Instruments GmbH.

© Copyright by Rebstock Instruments GmbH. Todos los derechos reservados. Queda prohibido la reproducción total o parcial. No parte de este catálogo debe ser procesado o reproducido por cualquier medio, comprendido el tratamiento informática sin la autorización escrita de Rebstock Instruments GmbH.

© I diritti d'autore sono di Rebstock Instruments GmbH, che si riserva tutti i diritti. La riproduzione, anche solo parziale, è vietata. Nessuna parte di questo catalogo può essere in alcuna forma riprodotta o elaborata e moltiplicata con l'uso di sistemi elettronici senza l'assenso scritto della ditta Rebstock Instruments GmbH.

	Seite
A	
ABRAMS	
- Pleurabiopsie-Nadel	320
ACLAND	
- Anlegepinzetten	23
- Approximatoren	22
- Doppelklemmen	22
- Einzelklemmen	22
- Gefäßclips	22
ADSON	
- Arterienklemmen	385
- Pinzetten	352,353,366
- Raspatorien	472
- Saugkanülen	316
- Wundspreizer	197
ADSON-BABY	
- Wundspreizer	193
ALEXANDER	
- Raspatorien	476
ALLIS	
- Darm- und Gewebefasszangen	423,424
ALLIS-BABY	
- Darm- und Gewebefasszangen	423
ALLISON	
- Lungenspatel	175
ALLPORT	
- Wundspreizer	189
ALM	
- Wundspreizer	189
Anastomosenklemmen	50-53,108-111,420,421
ANDERSON-ADSON	
- Wundspreizer	195
ANDREWS-PYNCHON	
- Saugrohre	313
Aneurysmen-Clip-System	13-19
- Anlegezangen	17
- Lagerungstrays	18-19
- MINI-Clips	15,16
- PHYNOX-Clips	13-16
- STANDARD-Clips	13,14
- TITAN-Clips	13-16
ANKENEY	
- Sternumspreizer	165,166
Anlege- und Entfernungszange für Bulldogklemmen	10
Anlegepinzetten für	
- ACLAND Gefäßclips	23
- Approximatoren	26
- Gefäßclips	26,29
- Mikro-Gefäßclips	27
Anlegezangen für	
- Aneurysmenclips	17
- EDWARD Clips	117
- Gefäßclips	30
- Ligaturclips	20
Aorta	
- Anastomosenklemmen	71
- Aneurysma-Klemmen	72-77
- Haken	178-180
- Klemmen	67-70,108-111
- Stanzen	181-183
Approximatoren	22,24,25
Arterienklemmen	370-385,392-401
- TITAN	372
Atraumatisch	
- Bulldogklemmen	3-8
- Gefäßklemmen	12,33-113
- Mehrzweckklemmen	62-66,103-105
- Organfaßzangen	80
- Pinzetten	122-134
Atriumhaken	176,177
Aurikelklemmen	40,41,422

	Seite
B	
BABCOCK	
- Darm- und Gewebefasszangen	425,426
BABY-ADSON	
- Arterienklemmen	386
BABY-CRILE-WOOD	
- Nadelhalter	433
BABY-MOSQUITO	
- Arterienklemmen	370
BABY-OVERHOLT	
- Präparier- und Ligaturklemmen	387
BABY-POOLE	
- Saugrohr	309
BACKHAUS	
- Tuchklemmen	408
BADGLEY	
- Laminektomie-Spreizer	149
BAILEY	
- Aortastanzen	182
- Rippenkontraktor	172
BAILEY-BABY	
- Rippenkontraktor	172
BAILEY-GIBBON	
- Rippenkontraktor	172
BAINBRIDGE	
- Atraumatische Mehrzweckklemmen	62
BALFOUR	
- Bauchdeckenhalter	199
BARRAQUER	
- Mikro-Nadelhalter	280,282
Bauchdeckenhalter	199
Bauchspatel	207,213,214
BAUMGARTNER	
- Drahtspannzange	490
- Nadelhalter	432
BEAL	
- Circumflex-Scheren	335
BECK	
- Atraumatische Mehrzweckklemmen	66
BECKMANN	
- Wundspreizer	196
BECKMANN-ADSON	
- Wundspreizer	194
BECKMANN-EATON	
- Wundspreizer	194
BENGOLEA	
- Arterienklemmen	384
BERLIN	
- Schlauchklemmen	404
BERRY	
- Drahtspannzange	491
BETHUNE	
- Rippenscheren	452
BEYER	
- Hohlmeisselzange	456
BIEMER	
- Anlegepinzetten	26
- Approximatoren	24
- Gefäßclips	24
- Gefäßspreizer	251
- Nerv-Approximatoren	24
- Venenscheren	276,277
BIEMER-MÜLLER	
- Approximatoren	25
BLAKE	
- Embolusfasszange	422
BOEHLER	
- Hohlmeisselzangen	456
- Knochensplittierzangen	463
BOROWSKI	
- Aortahaken	179
BOZEMANN	
- Nadelhalter	441
BRAUN-RALPH	
- Saugrohr	315
BRAUN-STADLER	
- Sternumschere	347

	Seite
BRIDGE	
- Arterienklemmen	396
BROMPTON	
- Rollenklemmen	406
Bronchusklemmen	37,417-419
BROPHY	
- Pinzetten	359
BRUNNER	
- Rippenscheren	454
BRUNS	
- Scharfe Löffel	469
Brustfell-Trokare	321
BÜCHS	
- Raspatorien	475
BUGGE	
- Mammaria-Sperrer	170
Bulldogklemmen	3-11
- mit Ringgriff	38,39,92-94
C	
CAIRNS	
- Nerv- und Gefäßhäkchen	248
- Wundspreizer	193
CAIRNS-DOTT	
- Pinzetten	363
Carotis-Shuntklemmen	86,113
CASPAR	
- Mikro-Dissektoren	252
CASTAÑEDA	
- Neonatal- und Pädiatrie-Klemmen	88-91
- Rippensperrer	136
CASTROVIEJO	
- Mikro-Nadelhalter	286-289
Chirurgische Scheren	322-324
CHITWOOD-DE BAKAY	
- Atraumatische Pinzetten	131
Clips	
- Aneurysmen-Clip-System	13-16
- Gefäß	22,24,27,28,30
Coarctationsklemmen	42-49,106,107
COLLIN	
- Rippenscheren	450
CONE	
- Wundspreizer	197
CONVERSE	
- Nadelhalter	431
COOLEY	
- Anastomosenklemmen	109,111
- Atraumatische Mehrzweckklemmen	103-105
- Atraumatische Pinzetten	126
- Atriumhaken	176,177
- Bulldogklemmen	6
- Bulldogklemmen mit Ringgriff	92-94
- Carotis-Shuntklemmen	113
- Coarctationsklemmen	106,107
- Gefäßdilatoren	257
- Herz-Dilatator	255
- Iliaca-Klemmen	108
- Katheterklemmen	95
- Neonatal- und Pädiatrie-Klemmen	96-102
- Rippenscheren	452
- Rippensperrer	136,138,139,140,145
- Saugrohre	310,314
- Tangentialklemmen	112
COOLEY-BECK	
- Anastomosenklemmen	108
COOLEY-DERRA	
- Anastomosenklemmen	110
COPE	
- Pleurabiopsie-Nadel	320
CORYLLOS	
- Rippenscheren	451
- Thoraxhaken	238
COTTLE	
- Nerv- und Gefäßhäkchen	248

Seite	Seite	Seite
CRAFOORD		FINOCHIETTO-BABY
- Arterienklemmen393		- Rippensperrer138
- Thorax-Schere347		FINOCHIETTO-BURFORD
CRAFOORD SELLORS		- Rippensperrer144,151,158
- Arterienklemmen394		FINSEN
CRAWFORD		- Wundspreizer188
- Aortahaken180		FINSTERER
CRILE		- Saugrohre315
- Arterienklemmen372,373		Flachzangen486-489
CRILE-WOOD		Flexible Gefäßklemmen118-119
- Nadelhalter433		FOERSTER
CUSHING		- Tupferzangen413
- Aortastanzen183		FOGARTY
- Nerv- und Gefäßhäkchen248		- Einsätze für Gefäßklemmen116
- Pinzetten359,363		- Gefäßklemmen für
- Venenhaken209		auswechselbare Mauleinsätze114,115
- Wundhaken209,211		FRAZIER
CUSHING-KOCHER		- Nerv- und Gefäßhäkchen248
- Wundhaken212		- Saugkanülen318
D		FREER
D'AMICO		- Elevatorium, Raspatorium254
- Saugrohre311		FREER-YASARGIL
DALE		- Elevatorium, Raspatorium254
- Peripher-Gefäßklemmen57		FRITSCH
DANDY		- Wundhaken231
- Arterienklemmen383		FRYKHOLM
DARDIK		- Hohlmeisselzangen460
- Atraumatische Gefäßklemmen60,61		FUCHSIG
DARLING		- Präparier- und Ligaturklemme387
- Wundspreizer198		G
Darm- und Gewebefasszangen423-429		GARRETT
DAVIDSON		- Gefäßdilatoren260
- Scapula Haken239		- Heparininjektor319
DAVIS		Gefäßclips22,24,27,28,30
- Elevatorium, Raspatorium254		Gefäßdilatoren250,251,257-263
DEAVER		Gefäßdissektoren265
- Bauchspatel213,214		Gefäßklemmen12
DE BAKEY		- flexible118-119
- Anastomosenklemmen52		- für auswechselbare Mauleinsätze114,115
- Aorta-Anastomosenklemmen71		- TITAN2
- Aorta-Aneurysma-Klemmen72,74,77		Gefäßscheren335-345
- Atraumatische Gefäßklemmen38,39,64,65		Gefäßspreizer251
- Atraumatische Mehrzweckklemmen64,65		Gefäßspülkanülen316,319
- Atraumatische Pinzetten122-125,127,128,		GEMINI
.....132-134		- Präparier- und Ligaturklemmen386
- Bulldogklemmen4,8		GEMINI mini
- Bulldogklemmen mit Ringgriff38,39		- Präparier- und Ligaturklemmen387
- Coarctationsklemmen42-46		GERALD
- Gefäßdilatoren258,259,261		- Pinzetten364
- Gefäßklemmen12		GIERTZ-STILLE
- Gefäßscheren338		- Rippenschere455
- Iliaca-Klemme81		GILLIES
- Ligaturklemmen85		- Nadelhalter445
- Nadelhalter434,435		- Nerv- und Gefäßhäkchen248
- Offsetschere340		- Pinzetten362
- Peripher-Gefäßklemmen54-56		GIL VERNET
- Präparier- und Ligaturklemmen83		- Sattelhäkchen208
- Rippensperrer144,154,156		GLASSMAN
- Saugkanülen313		- Atraumatische Pinzetten130
- Saugrohre313		GLOVER
- Venenkanülen319		- Anastomosenklemmen50,51
DE BAKEY-ADSON		- Bulldogklemmen7,8
- Atraumatische Pinzetten129		GLOVER-DE BAKEY
DE BAKEY-BAHNSON		- Atraumatische Gefäßklemmen36
- Aorta-Aneurysma-Klemmen73		GLUCK
DE BAKEY-BECK		- Rippenschere450
- Atraumatische Mehrzweckklemmen66		GREGORY
DE BAKEY-DIETHRICH		- Profunda-Klemmen87
- Atraumatische Pinzetten127		GREGORY „SOFT“
- Bulldogklemmen3		- Bulldogklemmen5
DE BAKEY-GERALD		GROSS-MAIER
- Atraumatische Pinzetten129		- Tupferzangen411
DE BAKEY(LAMBERT modif.)		GRUENWALD
- Aorta-Anastomosenklemme71		- Pinzetten366
DE BAKEY-MC QUIGG-MIXTER		GUNNER-HEY
- Präparier- und Ligaturklemme82		- Rollenklemmen406
DE BAKEY-MIXTER		
- Präparier- und Ligaturklemme84		
DE BAKEY-MORRIS		
- Aorta-Aneurysma-Klemmen75		
DE BAKEY-REYNOLDS		
- Anastomosenklemmen53		
DE BAKEY-RUMEL		
- Präparier- und Ligaturklemmen82		
DE BAKEY-SATINSKY		
- Tangentialklemmen79		
DE BAKEY-SEMB		
- Aorta-Aneurysma-Klemmen76		
- Präparier- und Ligaturklemme83		
DE BAKEY-WHEELER		
- Atraumatische Pinzetten130		
DERF		
- Nadelhalter431		
DERRA		
- Anastomosenklemmen52		
DESMARRES		
- Wundhaken210		
DIEFFENBACH		
- Bulldogklemmen11		
DIETHRICH		
- Aortaklemmen69		
- Bulldogklemmen3		
- Gefäßschere339		
DIETHRICH-HEGEMANN		
- Gefäßschere338		
Dissektoren253		
DIXON-LOVELACE		
- Arterienklemmen383		
DOYEN		
- Rippenraspatorien479-481		
- Sonde267		
Drahtkneifzangen492-495		
Drahtzwirbelzangen489-491		
DUBOST		
- Rippensperrer152		
DURANTE		
- Pinzetten369		
DUVAL		
- Darm- und Gewebefasszangen427		
E		
ECHLIN		
- Hohlmeisselzangen460		
EDWARDS		
- Anlegezange117		
- Clips117		
Einsätze für Gefäßklemmen116		
Elevatoren254		
Embolussfazzange422		
Epikardialspreizer187		
ETHICON		
- Anlegezangen20		
- Ligaturclips TITAN21		
F		
Fadenfänger256		
Fadenklemmen27,370		
Fadenschere349		
FARABEUF		
- Raspatorien474		
- Wundhaken200		
FARABEUF-COLLIN		
- Raspatorien474		
FAVOLORO		
- Coronararterien-Schere340		
FERGUSON		
- Knochenhaltezange466		
FINOCHIETTO		
- Bronchusklemmen417		
- Lungenlappenschere348		
- Nadelhalter442		
- Rippensperrer137,140,149,150		

Seite	Seite	Seite
H		
HABERER		
- Bauchspatel	207	
Hämmer	471	
HAIGHT		
- Rippensperrer	141	
HALSEY		
- Nadelhalter	431	
HALSTED-MOSQUITO		
- Arterienklemmen	371	
- Atraumatische Gefäßklemmen	34	
HALSTED-MOSQUITO micro		
- Arterienklemmen	371	
HARKEN		
- Aurikelklemmen	40,41,422	
HARRINGTON		
- Bronchusklemmen	417	
- Wundhaken	217	
HARRINGTON-BABY		
- Wundhaken	217	
HARVEY		
- Drahtknepfscheren	492	
- Drahtknepfzangen	494	
HEANEY		
- Nadelhalter	440	
HEGAR		
- Gefäßdilatatoren	262,263	
- Vascular Nadelhalter	437	
HEISS		
- Arterienklemmen	385	
HENLEY		
- Wundspreizer	190	
Heparininjektoren	319	
HERTZLER		
- I.M.A.-Spreizer	167	
Herz-Dilatatoren	255	
Herzklappen-Fasszange	429	
HIBBS		
- Wundhaken	237	
HOHENFELLNER		
- Gefäßscheren	344	
Hohlmeisselzangen	456-461	
HOPT		
- Atraumatische Gefäßklemmen	35	
I		
Iliaca-Klemme	81,108	
I.M.A.		
- Epikardialspreizer	187	
- Heparinnadel	319	
- Mammaria Sperrer	168	
- Spreizer	167-170	
In-situ-Venenklappe Scheren	343	
Intima-Spatel	266	
IRIS		
- Scheren	333,334	
ISRAEL		
- Wundhaken	226	
J		
JACOBSON		
- Knopfsonden	251	
- Mikro-Gefäßscheren	276,277	
- Mikro-Nadelhalter	286-289	
JANSEN		
- Pinzetten	366	
- Raspatorien	473	
- Wundspreizer	189	
JAVID		
- Carotis-Shuntklemmen	86	
JEFFERSON		
- Pinzetten	352,353	
- Wundspreizer	193	
JOHNS-HOPKINS		
- Bulldogklemmen	10	
JONES		
- Tuchklemmen	407	
JONES-CLIP		
- Tuchklemmen	407	
JORGENSEN		
- Thorax-Schere	348	
JOSEPH		
- Scheren	332	
JUDD-ALLIS		
- Darm- und Gewebefasszangen	423	
K		
KADER		
- Wundhaken	206	
KANTROWITZ		
- Arterienklemmen	396	
KARP		
- Aortastanzen	181	
Katheterklemmen	95	
KELLY		
- Arterienklemmen	372,397	
- Wundhaken	205,235	
KILLIAN		
- Elevatorium, Raspatorium	254	
KILNER		
- Scheren	332	
KLINKENBERG-LOTH		
- Thorax-Schere	348	
Knochendraht	486	
Knochenhalte-zangen	466-467	
Knochensplitterzangen	461-465	
Knopfsonde	251	
Knorpelschere	342	
KOCHER		
- Arterienklemmen	379	
- Wundhaken	212,221-223,230,232	
KOCHER-LANGENBECK		
- Wundhaken	229	
KOCHER-NIPPON		
- Arterienklemmen	381	
KOCHER-WAGNER		
- Wundhaken	233	
KOENIG		
- Wundhaken	212	
KOERTE		
- Wundhaken	215	
KRÄMER		
- Raspatorien	475	
KRAYENBÜHL		
- Nerv- und Gefäßhäkchen	249	
L		
Lagerungstray		
- für Aneurysmen-Clips	18,19	
- für Gefäßklemmen	23	
LAHEY		
- Peritoneumklemmen	402	
LAMBERT-KAY		
- Aorta-Anastomosenklemmen	71	
LAMBOTTE		
- Raspatorien	473	
Laminektomie-Spreizer	149	
LANDOLT		
- Skalpgriffe	307	
LANE		
- Tuchklemmen	410	
LANGENBECK		
- Knochenhalte-zangen	466	
- Raspatorien	475	
- Wundhaken	227,228	
LANGENBECK-GREEN		
- Wundhaken	210	
LAWRENCE		
- Arterienklemmen	395	
LAZAR		
- Mikro-Pinzetten	296	
LEBSCHÉ		
- Rippenscheren	453	
- Sternummeißel	471	
LEES		
- Bronchusklemmen	37	
LEKSELL		
- Hohlmeisselzangen	459	
LEKSELL-STILLE		
- Hohlmeisselzangen	459	
LELAND-JONES		
- Atraumatische Mehrzweckklemmen	63	
LEMMON		
- Rippenkontraktoren	171	
LERICHE		
- Arterienklemmen	384	
- Wundhaken	215	
LEXER		
- Präparierscheren	327	
LEXER-FINO		
- Präparierscheren	326	
LICHTENBERG		
- Nadelhalter	444	
LIDDLE		
- Aortaklemmen	67	
Ligaturclips TITAN	21	
Ligaturklemmen	85	
LISTER		
- Sinusklemmen	415	
LISTON		
- Knochensplitterzangen	462	
LITTAUER		
- Fadenschere	349	
LITTLEWOOD		
- Darm- und Gewebefasszangen	428	
LOCKHART-MUMMERY		
- Sonden	268	
LORNA		
- Tuchklemmen	410	
LOVE-GRUENWALD		
- Aortastanzen	183	
LOVELACE		
- Lungenfasszangen	416	
LUCAE		
- Pinzetten	366	
Lungenfasszangen	416	
Lungenlappenschere	348	
Lungenspatel	175,239	
M		
Mammaria-Sperrer	168,170	
Mandrin	256	
MARQUARDT		
- Hohlmeisselzange	457	
MARTIN		
- Bauchspatel	207	
- Tupferzangen	414	
- Wundhaken	236	
MARTIN-WYLIE		
- Peripheal-Gefäßklemmen	58,59	
MATHIEU		
- Nadelhalter	443,444	
MATSON		
- Raspatorium	477	
MATSON ALEXANDER		
- Raspatorium	476	
MAYO		
- Präparierscheren	325	
MAYO-HEGAR		
- Nadelhalter	435	
MAYO-STILLE		
- Präparierscheren	326	
MC INDOE		
- Knochensplitterzangen	463	
- Knorpelschere	342	
- Pinzetten	362	
MC KISSOCK		
- Raspatorien	475	

	Seite
MC QUIGG-MIXTER	
- Arterienklemme	401
MEEKER	
- Arterienklemmen	396
MEHDORN	
- Anlegepinzette	26
- Gefäßclips	24
Mehrzweckklemmen	62-66,103-105
MERCEDES	
- Thoraxsperrer	160
METZENBAUM	
- Präparierscheren	328
METZENBAUM-FINO	
- Präparierscheren	329,330,331
METZENBAUM-NELSON	
- Präparierscheren	331
MICRO-ADSON	
- Arterienklemmen	399
- Pinzetten	351
MICRO-ADSON BIEMER	
- Pinzetten	351
Microvascular Nadelhalter	437
MIDDELDORFF	
- Wundhaken	202
Mikro	
- Dissektoren	247,252
- Gefäßclip	27
- Gefäßscheren	270-277
- Nadelhalter	278-289
- Phleboextraktoren	247
- Pinzetten	290-299
- Präparierscheren	274-277
- Ring-Pinzetten	290,291,295
- Venenscheren	276,277
MIKULICZ	
- Peritoneumklemmen	403
- Wundhaken	234
MIKULICZ-BABY	
- Peritoneumklemmen	402
MILLEST	
- Mikro-Gefäßscheren	276,277
MILLS	
- Gefäßschere	337
MISKIMOM	
- Wundspreizer	195
MIXTER	
- Arterienklemmen	398,400
MIXTER-BABY	
- Arterienklemmen	399
MIXTER-O'SHAUGNESSY	
- Arterienklemmen	400
MOCK (DE BAKEY)	
- Heparininjektor	319
MORSE	
- Sternumspreizer	162,164
MORSE-FAVOLORO	
- Sternumspreizer	163
MÜLLER	
- Approximatoren	25
- Fadenklemmen	27
- Gefäßclips	27
- Nerv- und Gefäßhäkchen	248
MURPHY	
- Schlauchklemmen	405
- Wundhaken	224
N	
NABATOFF	
- Venenstripper	242
Nadelhalter	431-445
- mikro	278-289
NEIVERT	
- Nadelhalter	432
NELSON	
- Brustfell-Trokare	321
- Pinzetten	367

	Seite
Neonatal- und Pädiatrie-Klemmen	88-91,96-101
Nerv-Präparierscheren	342
Nerv- und Gefäßhäkchen	248,249
O	
OCHSNER	
- Aortaklemmen	69
- Brustfell-Trokare	321
- Vaskular-Spreizer	199
OLSEN-HEGAR	
- Nadelhalter	445
OPPEL	
- Mikro-Dissektoren	252
Organfasszangen	80
OVERHOLT	
- Präparier- und Ligaturklemmen	390,391
- Raspatorien	477,478
OVERHOLT fino	
- Präparier- und Ligaturklemmen	390
OVERHOLT-GEISSENDOERFER	
- Präparier- und Ligaturklemmen	388,389
OVERHOLT-MIXTER	
- Präparier- und Ligaturklemmen	391
P	
PARKER-LANGENBECK	
- Wundhaken	202
PEAN	
- Arterienklemmen	378
- Atraumatische Gefäßklemmen	33
PEAN-NIPPON	
- Arterienklemmen	380
PEERS BERTRAM	
- Tuchklemme	408
PENNYBACKER	
- Dissektor	253
Peripheal-Gefäßklemmen	54-59
Peritoneumklemmen	402
PERWITZCHKY	
- Scheren	334
Pinzetten	350-369
- atraumatisch	122-134
- Mikro	290-299
- TITAN	123,125,133,350,352,362,364
PLESTER	
- Saugkanülen	317
Pleurabiopsie-Nadel	320
POOLE	
- Saugrohr	309
POPPEL	
- Saugkanülen	317
POTTS	
- Coarctationsklemmen	47-49
POTTS-DE MARTEL	
- Gefäßscheren	337,339
POTTS-SMITH	
- Gefäßscheren	335,337,339
- Pinzetten	361
POTTS-YASARGIL	
- Mikro-Gefäßscheren	276,277
Präparierscheren	325-331
Präparier- und	
- Ligaturklemmen	82-84,386-391,415,419
PRESBYTERIAN HOSPITAL	
- Schlauchklemmen	404
PRICE-THOMAS	
- Bronchusklemmen	418
Profunda-Klemmen	87
PROVIDENCE-HOSPITAL	
- Arterienklemmen	373

	Seite
R	
RAGNELL	
- Wundhaken	203
RAMEL	
- Pleurabiopsie-Nadel	320
RAMPLEY	
- Tupferzangen	414
RANKIN	
- Arterienklemmen	372
- Atraumatische Gefäßklemmen	34
Raspatorien	254,471-485
REILL	
- Drahtkneifzange	493
- Mikro-Nadelhalter	280-283
REYNOLDS	
- Scheren	333
RICHARDSON	
- Wundhaken	202,204
Rippenkontraktoren	171,172
Rippenraspatorien	479-481
Rippenscheren	448-455
Rippenspreizer	136-159
ROBB	
- Gefäßdissektoren	265
ROBERTS	
- Arterienklemmen	394
ROCHESTER-CARMALT	
- Arterienklemmen	383
ROCHESTER-OCHSNER	
- Arterienklemmen	376,377
ROCHESTER-PEAN	
- Arterienklemmen	374,375
Rollenklemmen	406
ROSS	
- Aortahaken	178
ROUX	
- Wundhaken	200,201
RUMEL	
- Arterienklemmen	392
RUMEL-BELMONT	
- Tourniquets	256
RUSKIN	
- Hohlmeisselzangen	457
RUSKIN-LISTON	
- Knochensplitterzangen	464
Russ.Mod. Pinzetten	368
RYDER	
- Nadelhalter	436
- Vascular Nadelhalter	438,439
S	
SANTULLI	
- Bulldogklemme	5
SANVERNO	
- Scheren	332
SAROT	
- Arterienklemmen	393
- Bronchusklemmen	419
- Nadelhalter	442
SATINSKY	
- Anastomosenklemmen	420,421
- Gefäßscheren	345
- Tangentialklemmen	78
Sattelhäkchen	208
SAUERBRUCH	
- Hohlmeisselzangen	459
- Rippenscheren	453
- Wundhaken	239
SAUERBRUCH-FREY	
- Rippenscheren	454
Saugkanülen	313,315-318
Saugrohre	309-317
Scapula Haken	239
SCHAEDEL	
- Tuchklemme	407

	Seite
Scharfe Löffel	468-470
SCHEDÉ	
- Scharfe Löffel	468
SCHÉIBE	
- Darm- und Gewebefasszangen	428
Scheren	322-349
- Chirurgische-	322-324
- Coronararterien-	340
- Faden-	349
- Gefäß-	335-345
- In-situ-Venenklappe-	343
- Knorpel-	342
- Lungenlappen-	348
- Mikro-	270-277
- Nerv-Präparier-	342
- Offset-	340
- Präparier-	325-331
- Sternum-	347
- SUPERCUT-	322-234, 327-329, 337
- Thorax-	346-348
Schlauchklemmen	404, 405
SCHMID	
- Intima-Spatel	266
- Gefäßspülkanülen	316
SCHNIDT	
- Präparier- und Ligaturklemmen	415
SCHOENBORN	
- Wundhaken	209
SCHUMACHER	
- Sternumschere	449
SCHWARTZ	
- Anlegezange für Gefäßclips	30
- Gefäßclips	30
Seitenschneider	492-495
SELLORS	
- Rippenkontraktor	171
SELMAN	
- Pinzetten	368
SEMB	
- Hohlmeisselzangen	460
- Knochenhaltezangen	467
- Knochensplitterzange	465
- Lungenspatel	175
- Präparier- und Ligaturklemmen	419
- Raspatorien	482, 483
SEMKEN	
- Pinzetten	350
SENN-MILLER	
- Wundhaken	203
SHUNT	
- Bulldogklemmen	9
SIMON	
- Wundhaken	236
SINGLEY-TUTTLE	
- Pinzetten	369
Sinusklemmen	415
Skalpelgriffe	302-308
- mikro	307-308
Skalpellklingen-Entferner	303
SMITH-PETERSEN	
- Hohlmeisselzangen	461
Sonden	267, 268
SPENCER	
- Fadenscheren	349
SPENCER-WELLS	
- Arterienklemmen	382
SPURLING	
- Aortastanzen	183
STANDARD	
- Anlegezangen für Ligaturclips	20
- Pinzetten	354, 356, 358
- Scheren	322-324
Standgefäße	261
Sternummeißel	471
Sternumscheren	347, 449
Sternumspreizer	162-166
STILLE	
- Rippenscheren	450

	Seite
STILLE-HORSLEY	
- Knochensplitterzange	465
STILLE-LISTON	
- Knochensplitterzangen	464, 465
STILLE-LUER	
- Hohlmeisselzangen	458
STRATÉ	
- Nadelhalter	440
STRUCK	
- Rippensperrerr	142
STRULLY	
- Gefäßscheren	341
SUBRAMANIAN	
- Aortaklemmen	68
SUBRAMANIAN MINIATURE	
- Aortaklemmen	68
SUPERCUT-Scheren	322-324, 327-329, 337
T	
Tangentialklemmen	78, 79, 112
TEALE	
- Herzklappen-Fasszange	429
TESSIER	
- Thoraxhaken	237
THOMS-ALLIS	
- Darm- und Gewebefasszangen	424
Thoraxhaken	237, 238
Thorax-Scheren	346-348
Thoraxsperrerr	160
THOREK	
- Thorax-Scheren	346
TITAN	
- Anastomosenklemmen	50-52, 108
- Aneurysmen-Clips	13-16
- Aorta-Anastomosenklemmen	71, 72
- Aorta-Aneurysma-Klemmen	76
- Aortaklemmen	68
- Arterienklemmen	372
- Atraumatische Mehrzweckklemmen	63, 65, 66
- Bronchusklemmen	37
- Carotis-Shuntklemmen	113
- Coarctationsklemmen	47, 106, 107
- Gefäßklemmen	2
- Iliaca-Klemmen	108
- Ligaturclips	21
- Periphéal-Gefäßklemmen	56
- Pinzetten	123, 125, 133, 350, 352, 362, 364
- Tangentialklemmen	78
TOENNIS	
- Dissektoren	253
- Nadelhalter	443
- Nerv- und Gefäßhákchen	248
TOENNIS-ADSON	
- Gefäßschere	341
TOHOKU	
- Tuckklemmen	409
Tourniquets	256
TUBBS	
- Herz-Dilatator	255
Tuckklemmen	407-410
TUFFIER	
- Rippensperrerr	148
Tunnelierbesteck	264
Tupferzangen	411-414
U	
ULRICH	
- Tupferzangen	412
US ARMY (PARKER-LANGENBECK)	
- Wundhaken	202
V	
VANDERBILT	
- Arterienklemmen	392
VANNAS	
- Mikro-Gefäßscheren	274-277

	Seite
VARADY	
- Dissektor, mikro	247
- Phlebodissektor	246
- Phleboextraktoren	246, 247
- Phleboextraktoren, mikro	247
- Venenstripper	243
Varizeninstrumente	246, 247
Vaskular-Spreizer	199
Venenhaken	209
Venenkanülen	319
Venenscheren	276, 277
Venenstripper	242-245
VIÉ	
- Mikro-Pinzetten	297
VOLKMAN	
- Scharfe Löffel	470
- Wundhaken	218-220, 225
W	
WALTON-YANKAUER	
- Saugrohr	312
WANGENSTEEN	
- Nadelhalter	441
- Pinzetten	367
WAUGH	
- Pinzetten	365
WEBER	
- Aortaklemmen	70
WEBSTER	
- Nadelhalter	432
WEINBERG	
- Rippensperrerr	139
WEITLANER	
- Wundspreizer	191, 192
WEITLANER-BECKMANN	
- Wundspreizer	196
WICKSTROEM	
- Arterienklemmen	401
WILLAUER	
- Thorax-Scheren	346
WILLIAMS	
- Darm- und Gewebefasszangen	429
WOLF	
- Saugrohre	311
Wundhaken	200-206, 208-212, 215-236, 239
Wundspreizer	187-199
WYLIE	
- Atraumatische Gefäßklemmen	36
Y	
YANKAUER	
- Saugrohre	312
YANKAUER-BABY	
- Saugrohr	312
YASARGIL	
- Aneurysmen-Clip-System	13-19
- Anlegepinzette für Gefäßclips	27
- Anlegezangen für Aneurysmen-Clips	17
- Mikro-Dissektoren	252
- Mikro-Gefäßclip	27
- Mikro-Gefäßschere	276, 277
Z	
ZANGER	
- Heparininjektor	319
ZAUFAL-JANSEN	
- Hohlmeisselzange	456
ZENKER	
- Arterienklemmen	395
- Wundhaken	216

	page
CRAFOORD	
- Hemostatic Forceps	393
- Thoracic Scissors	347
CRAFOORD SELLORS	
- Hemostatic Forceps	394
CRAWFORD	
- Aorta Retractors	180
CRILE	
- Hemostatic Forceps	372,373
CRILE-WOOD	
- Needle Holders	433
CUSHING	
- Aortic Punches	183
- Forceps	359,363
- Nerve and Vessel Hooks	248
- Retractors	209,211
- Vein Retractors	209
CUSHING-KOCHER	
- Retractors	212
D	
D'AMICO	
- Suction Tubes	311
DALE	
- Peripheal Vascular Clamps	57
DANDY	
- Hemostatic Forceps	383
DARDIK	
- Atraumatic Vessel Clamps	60,61
DARLING	
- Self-retaining Retractors	198
DAVIDSON	
- Scapula Retractors	239
DAVIS	
- Elevators, Raspatories	254
DEAVER	
- Abdominal Spatulas	213,214
DE BAKEY	
- Anastomosis Clamps	52
- Aorta-Anastomosis Clamps	71
- Aorta-Aneurysm Clamps	72,74,77
- Atraumatic Forceps	122-125,127,128,132-134
- Atraumatic Multi-Purpose Clamps	64,65
- Atraumatic Vessel Clamps	38,39,64,65
- Bulldog Clamps	4,8
- Coarctation Clamps	42-46
- Dissecting and Ligature Forceps	83
- Iliac Clamps	81
- Ligature Clamps	85
- Needle Holders	434,435
- Offset Scissors	340
- Peripheal Vascular Clamps	54-56
- Rib Spreaders	144,154,156
- Ring Bulldog Clamps	38,39
- Suction Cannulae	313
- Suction Tubes	313
- Vascular Dilators	258,259,261
- Vascular Scissors	338
- Vein Cannulae	319
- Vessel Clamps	12
DE BAKEY-ADSON	
- Atraumatic Tissue Forceps	129
DE BAKEY-BAHNSON	
- Aorta-Aneurysm Clamps	73
DE BAKEY-BECK	
- Atraumatic Multi-Purpose Clamps	66
DE BAKEY-DIETHRICH	
- Atraumatic Forceps	127
- Bulldog Clamps	3
DE BAKEY-GERALD	
- Atraumatic Forceps	129
DE BAKEY(LAMBERT modif.)	
- Aorta-Anastomosis Clamps	71
DE BAKEY-MC QUIGG-MIXTER	
- Dissecting and Ligature Forceps	82

	page
DE BAKEY-MIXTER	
- Dissecting and Ligature Forceps	84
DE BAKEY-MORRIS	
- Aorta-Aneurysm Clamps	75
DE BAKEY REYNOLDS	
- Anastomosis Clamps	53
DE BAKEY-RUMEL	
- Dissecting and Ligature Forceps	82
DE BAKEY-SATINSKY	
- Tangential Occlusion Clamps	79
DE BAKEY-SEMB	
- Aorta-Aneurysm Clamps	76
- Dissecting and Ligature Forceps	83
DE BAKEY-WHEELER	
- Atraumatic Forceps	130
DERF	
- Needle Holders	431
DERRA	
- Anastomosis Clamps	52
DESMARRES	
- Retractors	210
DIEFFENBACH	
- Bulldog Clamps	11
DIETHRICH	
- Aortic Clamps	69
- Bulldog Clamps	3
- Vascular Scissors	339
DIETHRICH-HEGEMANN	
- Vascular Scissors	338
Dilator and Instrument Jars	261
Dissecting and Ligature Forceps	82-84,386-391,415,419
Dissecting Scissors	325-331
Dissectors	253
DIXON-LOVELACE	
- Hemostatic Forceps	383
DOYEN	
- Probe	267
- Rib Raspatories	479-481
Dressing Forceps	411-414
DUBOST	
- Rip Spreaders	152
DURANTE	
- Forceps	369
DUVAL	
- Intestinal and Tissue Grasping Forceps	427
E	
ECHLIN	
- Bone Rongeurs	460
EDWARDS	
- Applying Forceps	117
- Clips	117
Elevators	254
Embolus Grasping Forceps	422
Epicardial Retractors	187
ETHICON	
- Applying Forceps	20
- Ligaturclips TITANIUM	21
F	
FARABEUF	
- Periosteal Elevators	474
- Retractors	200
FARABEUF-COLLIN	
- Periosteal Elevators	474
FAVOLORO	
- Coronary Artery Scissors	340
FERGUSON	
- Bone Holding Forceps	466
FINOCHIETTO	
- Bronchus Forceps	417
- Lobectomy Scissors	348
- Needle Holders	442
- Rib Spreaders	137,140,149,150

	page
FINOCHIETTO-BABY	
- Rib Spreaders	138
FINOCHIETTO-BURFORD	
- Rib Spreaders	144,151,158
FINSEN	
- Self-retaining Retractors	188
FINSTERER	
- Suction Tubes	315
Flat Nose Pliers	486-489
Flexible Vessel Clamps	118-119
FOERSTER	
- Dressing Forceps	413
FOGARTY	
- Interchangeable Jaw Inserts for Vessel Clamps	116
- Vessel Clamps for Interchangeable Jaw Inserts	114,115
Forceps	350-369
- atraumatic	122-134
- Micro	290-299
- TITANIUM	123,125,133,350,352,362,364
FRAZIER	
- Nerve and Vessel Hooks	248
- Suction Cannulae	318
FREER	
- Elevators, Raspatories	254
FREER-YASARGIL	
- Elevators, Raspatories	254
FRITSCH	
- Retractors	231
FRYKHOLM	
- Bone Rongeurs	460
FUCHSIG	
- Dissecting and Ligature Forceps	387
G	
GARRETT	
- Heparin Injector	319
- Vascular Dilators	260
GEMINI	
- Dissecting and Ligature Forceps	386
GEMINI mini	
- Dissecting and Ligature Forceps	387
GERALD	
- Forceps	364
GIERTZ-STILLE	
- Rib Shears	455
GILLIES	
- Forceps	362
- Needle Holders	445
- Nerve and Vessel Hooks	248
GIL VERNET	
- Saddle Hook	208
GLASSMAN	
- Atraumatic Forceps	130
GLOVER	
- Anastomosis Clamps	50,51
- Bulldog Clamps	7,8
GLOVER-DE BAKEY	
- Atraumatic Vessel Clamps	36
GLUCK	
- Rib Shears	450
GREGORY	
- Profunda Clamps	87
GREGORY „SOFT“	
- Bulldog Clamps	5
GROSS-MAIER	
- Dressing Forceps	411
GRUNWALD	
- Forceps	366
Guide	256
GUNNER-HEY	
- Tube Milking Rollers	406

	page		page
H		JOHNS-HOPKINS	
HABERER		- Bulldog Clamps	10
- Abdominal Spatulas	207	JONES	
HAIGHT		- Towel Clamps	407
- Rib Spreaders	141	JONES-CLIP	
HALSEY		- Towel Clamps	407
- Needle Holders	431	JORGENSEN	
HALSTED-MOSQUITO		- Thoracic Scissors	348
- Atraumatic Vessel Clamps	34	JOSEPH	
- Hemostatic Forceps	371	- Scissors	332
HALSTED-MOSQUITO micro		JUDD-ALLIS	
- Hemostatic Forceps	371	- Intestinal and Tissue Grasping Forceps	423
HARKEN		K	
- Auricle Clamps	40,41,422	KADER	
HARRINGTON		- Retractors	206
- Bronchus Forceps	417	KANTROWITZ	
- Retractors	217	- Hemostatic Forceps	396
HARRINGTON-BABY		KARP	
- Retractors	217	- Aortic Punches	181
HARVEY		KELLY	
- Wire Cutting Pliers	494	- Hemostatic Forceps	372,397
- Wire Cutting Shears	492	- Retractors	205,235
HEANEY		KILLIAN	
- Needle Holders	440	- Elevators, Raspatories	254
HEGAR		KILNER	
- Vascular Dilators	262,263	- Scissors	332
- Vascular Needle Holders	437	KLINKENBERG-LOTH	
HEISS		- Thoracic Scissors	348
- Hemostatic Forceps	385	KOCHER	
Hemostatic Forceps	370-385,392-401	- Hemostatic Forceps	379
- TITANIUM	372	- Retractors	212,221-223,230,232
HENLEY		KOCHER-LANGENBECK	
- Self-retaining Retractors	190	- Retractors	229
Heparin Injector	319	KOCHER-NIPPON	
HERTZLER		- Hemostatic Forceps	381
- I.M.A. Retractors	167	KOCHER-WAGNER	
HIBBS		- Retractors	233
- Retractors	237	KOENIG	
HOHENFELLNER		- Retractors	212
- Vascular Scissors	344	KOERTE	
HOPT		- Retractors	215
- Atraumatic Vessel Clamps	35	KRÄMER	
I		- Periosteal Elevators	475
Iliac Clamps	81,108	KRAYENBÜHL	
I.M.A.		- Nerve and Vessel Hooks	249
- Epicardial Retractors	187	L	
- Heparin Flushing Needle	319	LAHEY	
- Mammaria Retractor	168	- Peritoneal Clamp Forceps	402
- Retractors	167-170	LAMBERT-KAY	
In-situ Venous Valve Scissors	343	- Aorta-Anastomosis Clamps	71
Interchangeable Jaw Inserts for		LAMBOTTE	
Vessel Clamps	116	- Periosteal Elevators	473
Intestinal and Tissue Grasping Forceps	423-429	Laminectomy Spreader	149
Intima Spatula	266	LANDOLT	
IRIS		- Scalpel Handles	307
- Scissors	333,334	LANE	
ISRAEL		- Towel Clamps	410
- Retractors	226	LANGENBECK	
J		- Bone Holding Forceps	466
JACOBSON		- Periosteal Elevators	475
- Buttoned Probes	251	- Retractors	227,228
- Micro Needle Holders	286-289	LANGENBECK-GREEN	
- Micro Vascular Scissors	276,277	- Retractors	210
JANSEN		LAWRENCE	
- Forceps	366	- Hemostatic Forceps	395
- Periosteal Elevators	473	LAZAR	
- Self-retaining Retractors	189	- Micro Forceps	296
JAVID		LEBSCHÉ	
- Carotid Shunt Clamps	86	- Rib Shears	453
JEFFERSON		- Sternum Chisel	471
- Forceps	352,353	LEES	
- Self-retaining Retractors	193	- Bronchus Forceps	37
		LEKSELL	
		- Bone Rongeurs	459
		LEKSELL-STILLE	
		- Bone Rongeurs	459
		LELAND-JONES	
		- Atraumatic Multi-Purpose Clamps	63
		LEMMON	
		- Rib Contractors	171
		LERICHE	
		- Hemostatic Forceps	384
		- Retractors	215
		LEXER	
		- Dissecting Scissors	327
		LEXER-FINO	
		- Dissecting Scissors	326
		LICHTENBERG	
		- Needle Holders	444
		LIDDLE	
		- Aortic Clamps	67
		Ligature Catchers	256
		- Clamps	85
		- Clips TITANIUM	21
		- Forceps	27,370
		LISTER	
		- Sinus Forceps	415
		LISTON	
		- Bone Cutting Forceps	462
		LITTAUER	
		- Stich Scissors	349
		LITTLEWOOD	
		- Intestinal and Tissue Grasping Forceps	428
		Lobectomy Scissors	348
		LOCKHART-MUMMERY	
		- Probes	268
		LORNA	
		- Towel Clamps	410
		LOVE-GRUENWALD	
		- Aortic Punches	183
		LOVELACE	
		- Lung Grasping Forceps	416
		LUCAE	
		- Forceps	366
		Lung Grasping Forceps	416
		Lung Spatulas	175,239
		M	
		Mallets	471
		Mammaria Retractors	168,170
		MARQUARDT	
		- Bone Rongeurs	457
		MARTIN	
		- Abdominal Spatulas	207
		- Dressing Forceps	414
		- Retractors	236
		MARTIN-WYLIE	
		- Peripheal Vascular Clamps	58,59
		MATHIEU	
		- Needle Holders	443,444
		MATSON	
		- Raspatory	477
		MATSON ALEXANDER	
		- Raspatory	476
		MAYO	
		- Dissecting Scissors	325
		MAYO-HEGAR	
		- Needle Holders	435
		MAYO-STILLE	
		- Dissecting Scissors	326
		MC INDOE	
		- Bone Cutting Forceps	463
		- Cartilage Scissors	342
		- Forceps	362
		MC KISSOCK	
		- Raspatories	475
		MC QUIGG-MIXTER	
		- Hemostatic Forceps	401
		MEEKER	
		- Hemostatic Forceps	396

	page
MEHDORN	
- Applying Forceps	26
- Vessel Clips	24
MERCEDES	
- Thoracic Retractor	160
METZENBAUM	
- Dissecting Scissors	328
METZENBAUM-FINO	
- Dissecting Scissors	329,330,331
METZENBAUM-NELSON	
- Dissecting Scissors	331
Micro	
- Dissecting Scissors	274-277
- Dissectors	247,252
- Forceps	290-299
- Needle Holders	278-289
- Phleboextractor	247
- Ring-Forceps	290,291,295
- Vascular Scissors	270-277
- Vein Scissors	276,277
- Vessel Clip	27
MICRO-ADSON	
- Forceps	351
- Hemostatic Forceps	399
MICRO-ADSON BIEMER	
- Forceps	351
Microvascular Needle Holders	437
MIDDELDORPF	
- Retractors	202
MIKULICZ	
- Peritoneal Clamp Forceps	403
- Retractors	234
MIKULICZ-BABY	
- Peritoneal Clamp Forceps	402
MILLEST	
- Micro Vascular Scissors	276,277
MILLS	
- Vascular Scissors	337
MISKIMOM	
- Self-retaining Retractors	195
Mitral Valve Dilators	255
MIXTER	
- Hemostatic Forceps	398,400
MIXTER-BABY	
- Hemostatic Forceps	399
MIXTER-O'SHAUGNESSY	
- Hemostatic Forceps	400
MOCK (DE BAKEY)	
- Heparin Injector	319
MORSE	
- Sternal Retractors	162,164
MORSE-FAVOLORO	
- Sternal Retractors	163
MÜLLER	
- Approximators	25
- Ligature Forceps	27
- Nerve and Vessel Hooks	248
- Vessel Clips	27
Multi-Purpose Clamps	62-66,103-105
MURPHY	
- Retractors	224
- Tubing Clamps	405
N	
NABATOFF	
- Vein Strippers	242
Needle Holders	431-445
- micro	278-289
NEIVERT	
- Needle Holders	432
NELSON	
- Forceps	367
- Thoracic Trocars	321
Neonatal and Pediatric Clamps	88-91,96-101
Nerve and Vessel Hooks	248,249
Nerve Dissecting Scissors	342

	page
O	
OCHSNER	
- Aortic Clamps	69
- Thoracic Trocars	321
- Vascular Retractor	199
OLSEN-HEGAR	
- Needle Holders	445
Operating Scissors	322-324
OPPEL	
- Micro Dissector	252
Organ Grasping Forceps	80
OVERHOLT	
- Dissecting and Ligature Forceps	390,391
- Periosteal Elevators	477,478
OVERHOLT fino	
- Dissecting and Ligature Forceps	390
OVERHOLT-GEISSENDOERFER	
- Dissecting and Ligature Forceps	388,389
OVERHOLT-MIXTER	
- Dissecting and Ligature Forceps	391
P	
PARKER-LANGENBECK	
- Retractors	202
PEAN	
- Atraumatic Vessel Clamps	33
- Hemostatic Forceps	378
PEAN-NIPPON	
- Hemostatic Forceps	380
PEERS BERTRAM	
- Towel Clamps	408
PENNYBACKER	
- Dissector	253
Periosteal Elevators	254,471-485
Peripheal Vascular Clamps	54-59
Peritoneal Clamp Forceps	402
PERWITZCHKY	
- Scissors	334
PLESTER	
- Suction Cannulae	317
Pleural Biopsy Needles	320
POOLE	
- Suction Tubes	309
POPPEL	
- Suction Cannulae	317
POTTS	
- Coarctation Clamps	47-49
POTTS-DE MARTEL	
- Vascular Scissors	337,339
POTTS-SMITH	
- Forceps	361
- Vascular Scissors	335,337,339
POTTS-YASARGIL	
- Micro Vascular Scissors	276,277
PRESBYTERIAN HOSPITAL	
- Tubing Clamps	404
PRICE-THOMAS	
- Bronchus Forceps	418
Probes	267,268
Profunda Clamps	87
PROVIDENCE-HOSPITAL	
- Hemostatic Forceps	373
R	
RAGNELL	
- Retractors	203
RAMEL	
- Pleural Biopsy Needle	320
RAMPLEY	
- Dressing Forceps	414
RANKIN	
- Atraumatic Vessel Clamps	34
- Hemostatic Forceps	372
REILL	
- Micro Needle Holders	280-283

- Wire Cutting Pliers	493
Retractors	200-206,208-212,215-236,239
REYNOLDS	
- Scissors	333
Rib Contractors	171,172
Rib Raspatories	479-481
Rib Shears	448-455
Rib Spreaders	136-159
RICHARDSON	
- Retractors	202,204
Ring Bulldog Clamps	38,39,92-94
ROBB	
- Vascular Dissectors	265
ROBERTS	
- Hemostatic Forceps	394
ROCHESTER-CARMALT	
- Hemostatic Forceps	383
ROCHESTER-OCHSNER	
- Hemostatic Forceps	376,377
ROCHESTER-PEAN	
- Hemostatic Forceps	374,375
ROSS	
- Aorta Retractors	178
ROUX	
- Retractors	200,201
RUMEL	
- Hemostatic Forceps	392
RUMEL-BELMONT	
- Tourniquets	256
RUSKIN	
- Bone Rongeurs	457
RUSKIN-LISTON	
- Bone Cutting Forceps	464
Russ.Mod. Forceps	368
RYDER	
- Needle Holders	436
- Vascular Needle Holders	438,439
S	
Saddle Hook	208
SANTULLI	
- Bulldog Clamps	5
SANVERNO	
- Scissors	332
SAROT	
- Bronchus Forceps	419
- Hemostatic Forceps	393
- Needle Holders	442
SATINSKY	
- Anastomosis Clamps	420,421
- Tangential Occlusion Clamps	78
- Vascular Scissors	345
SAUERBRUCH	
- Bone Rongeurs	459
- Retractors	239
- Rib Shears	453
SAUERBRUCH-FREY	
- Rib Shears	454
Scalpel Blade Remover	303
Scalpel Handles	302-308
- micro	307-308
Scapula Retractors	239
SCHAEDEL	
- Towel Clamps	407
SCHEDI	
- Bone Curettes	468
SCHIEBE	
- Intestinal and Tissue Grasping Forceps	428
Scissors	322-349
- Cartilage	342
- Coronary Artery	340
- Dissecting	325-331
- In-situ Venous Valve	343
- Lobectomy	348
- Micro	270-277
- Nerve Dissecting	342
- Offset	340

	page		page		page
- Operating	322-324	T		- Retractor	199
- Sternum	347	Tangential Occlusion Clamps	78,79,112	- Scissors	335-345
- Stitch	349	TEALE		Vein Cannulae	319
- SUPERCUT	322-324,327-329,337	- Cardiac Valve Grasping Forceps	429	- Scissors	276,277
- Thoracic	346-348	TESSIER		- Strippers	242-245
- Vascular	335-345	- Thorax Retractors	237	Vessel Clamps	12
SCHMID		THOMS-ALLIS		- for Interchangeable Jaw Inserts	114,115
- Intima Spatula	266	- Intestinal and Tissue Grasping Forceps	424	- TITANIUM	2
- Vascular Irrigation Cannulae	316	Thoracic Retractors	160,237,238	Vessel Clips	22,24,27,28,30
SCHNIDT		- Scissors	346-348	Vessel Spreaders	251
- Dissecting and Ligature Forceps	415	- Trocars	321	WISE	
SCHOENBORN		THOREK		- Micro Forceps	297
- Retractors	209	- Thoracic Scissors	346	VOLKMAN	
SCHUMACHER		TITANIUM		- Bone Curettes	470
- Sternum scissors	449	- Anastomosis Clamps	50-52,108	- Retractors	218-220,225
SCHWARTZ		- Aneurysm Clips	13-16	W	
- Applying Forceps for Vessel Clips	30	- Aorta-Anastomosis Clamps	71,72	WALTON-YANKAUER	
- Vessel Clips	30	- Aorta-Aneurysm Clamps	76	- Suction Tubes	312
Self-retaining Retractors	187-199	- Aortic Clamps	68	WANGENSTEEN	
SELLORS		- Atraumatic		- Forceps	367
- Rib Contractors	171	- Multi-Purpose Clamps	63,65,66	- Needle Holders	441
SELMAN		- Bronchus Forceps	37	WAUGH	
- Forceps	368	- Carotid Shunt Clamps	113	- Forceps	365
SEMB		- Coarctation Clamps	47,106,107	WEBER	
- Bone Cutting Forceps	465	- Forceps	123,125,133,350,352,362,364	- Aortic Clamps	70
- Bone Holding Forceps	467	- Hemostatic Forceps	372	WEBSTER	
- Bone Rongeurs	460	- Iliac Clamp	108	- Needle Holders	432
- Dissecting and Ligature Forceps	419	- Ligature Clips	21	WEINBERG	
- Lung Spatulas	175	- Peripheal-Vascular Clamps	56	- Rib Spreaders	139
- Periosteal Elevators	482,483	- Tangential Occlusion Clamps	78	WEITLANER	
SEMKEN		- Vessel Clamps	2	- Self-retaining Retractors	191,192
- Forceps	350	TOENNIS		WEITLANER-BECKMANN	
SENN-MILLER		- Dissectors	253	- Self-retaining Retractors	196
- Retractors	203	- Needle Holders	443	WICKSTROEM	
SHUNT		- Nerve and Vessel Hooks	248	- Hemostatic Forceps	401
- Bulldog Clamps	9	TOENNIS-ADSON		WILLAUER	
SIMON		- Vascular Scissors	341	- Thoracic Scissors	346
- Retractors	236	TOHOKU		WILLIAMS	
SINGLEY-TUTTLE		- Towel Clamps	409	- Intestinal and Tissue Grasping Forceps	429
- Forceps	369	Tourniquets	256	Wire Cutting Pliers	492-495
Sinus Forceps	415	Towel Clamps	407-410	Wire Twisting Forceps	489-491
SMITH-PETERSEN		TUBBS		WOLF	
- Bone Rongeurs	461	- Mitral Valve Dilators	255	- Suction Tubes	311
SPENCER		Tube Milking Rollers	406	WYLIE	
- Stitch Scissors	349	Tubing Clamps	404,405	- Atraumatic Vessel Clamps	36
SPENCER-WELLS		TUFFIER		Y	
- Hemostatic Forceps	382	- Rip Spreaders	148	YANKAUER	
SPURLING		Tunneling Set	264	- Suction Tubes	312
- Aortic Punches	183	U		YANKAUER-BABY	
STANDARD		ULRICH		- Suction Tubes	312
- Applying Forceps for Ligature Clips	20	- Dressing Forceps	412	YASARGIL	
- Forceps	354,356,358	US ARMY (PARKER-LANGENBECK)		- Aneurysm Clip System	13-19
- Scissors	322-324	- Retractors	202	- Applying Forceps for Aneurysm Clips	17
Sternal Retractors	162-166	Utility Tray		- Applying Forceps for Vessel Clips	27
Sternum Chisel	471	- for Aneurysm Clips	18,19	- Micro Dissector	252
Sternum Scissors	347,449	- for Vessel Clamps	23	- Micro Vascular Scissors	276,277
STILLE		V		- Micro Vessel Clip	27
- Rib Shears	450	VANDERBILT		Z	
STILLE-HORSLEY		- Hemostatic Forceps	392	ZANGER	
- Bone Cutting Forceps	465	VANNAS		- Heparin Injector	319
STILLE-LISTON		- Micro Vascular Scissors	274-277	ZAUFAL-JANSEN	
- Bone Cutting Forceps	464,465	VARADY		- Bone Rongeurs	456
STILLE-LUER		- Micro Dissector	247	ZENKER	
- Bone Rongeurs	458	- Micro Phleboextractor	247	- Hemostatic Forceps	395
Stitch Scissors	349	- Phleboextractor	246	- Retractors	216
STRATTE		- Phleboextractor	246,247	Z	
- Needle Holders	440	- Vein Strippers	243	Z	
STRUCK		Varix Instruments	246,247	Z	
- Rip Spreaders	142	Vascular		Z	
STRULLY		- Clamps, flexible	118-119	Z	
- Vascular Scissors	341	- Dilators	250,251,257-263	Z	
SUBRAMANIAN		- Dissectors	265	Z	
- Aortic Clamps	68	- Irrigation Cannulae	316,319	Z	
SUBRAMANIAN MINIATURE				Z	
- Aortic Clamps	68			Z	
Suction Cannulae	313,315-318			Z	
Suction Tubes	309-317			Z	
SUPERCUT Scissors	322-324,327-329,337			Z	

	page		page		page
A		BARRAQUER		CASTROVIEJO	
ABRAMS		- Micro-Porte-aiguilles	280,282	- Micro-Porte-aiguilles	286-289
- Aiguille de biopsie pleurale	320	BAUMGARTNER		CHITWOOD-DE BAKEY	
ACLAND		- Pincés à torsader le fil	490	- Pincés atraumatiques	131
- Approximateurs	22	- Porte-aiguilles	432	Ciseau-burin à sternum	471
- Clips doubles	22	BEAL		Ciseaux	322-349
- Clips simples	22	- Circumflex ciseaux	335	- à chirurgie	322-324
- Clips vasculaires	22	BECK		- à dissection	325-331
- Pincés à appliquer des clips	23	- Pincés atraumatiques polyvalentes	66	- à fil	349
ADSON		BECKMANN		- à lobectomie	348
- Ecarteurs autostatiques	197	- Ecarteurs autostatiques	196	- à préparation de nerfs	342
- Pincés	352,353,366	BECKMANN-ADSON		- à sternum	347
- Pincés hémostatiques	385	- Ecarteurs autostatiques	194	- artère coronaire	340
- Rugines	472	BECKMANN-EATON		- compensé	340
- Tubes d'aspiration	316	- Ecarteurs autostatiques	194	- In-situ pour la valve veineuse	343
ADSON-BABY		BENGOLEA		- micro	270-277
- Ecarteurs autostatiques	193	- Pincés hémostatiques	384	- pour cartilage	342
Aiguille de biopsie pleurale	320	BERLIN		- pour veines	276,277
Aiguilles vasculaires pour irrigation	316,319	- Pincés serre-tubes	404	- thoraciques	346-348
ALEXANDER		BERRY		- SUPERCUT.....	322-324,327-329,327
- Rugines	476	- Pincés à torsader le fil	491	- vasculaires	335-34
ALLIS		BETHUNE		Clamps Bulldog	3-11
- Pincés à saisir les intestins		- Costotomes	452	- manche à anneau	38,39,92-94
et les tissus	423,424	BEYER		Clamps vasculaires	12
ALLIS-BABY		- Pincés-gouges	456	- TITANE	2
- Pincés à saisir les intestins et les tissus	423	BIEMER		Clip contenant pour le stockage	
ALLISON		- Approximateurs	24	des clips anévrismaux	18,19
- Tubes d'aspiration	175	- Approximateurs pour nerfs	24	Clips	
ALLPORT		- Ciseaux pour veines	276,277	- Système de clips anévrismaux	13-16
- Ecarteurs autostatiques	189	- Clips vasculaires	24	- vasculaires	22,24,27,28,30
ALM		- Ecarteurs pour vaisseaux	251	- TITANE à ligature	21
- Ecarteurs autostatiques	189	- Pincés à appliquer	26	COLLIN	
- Pincés à anastomose	50-53,108-111,420,421	BIEMER-MÜLLER		- Costotomes	450
ANDERSON-ADSON		- Approximateurs	25	CONE	
- Ecarteurs autostatiques	195	BLAKE		- Ecarteurs autostatiques	197
ANDREWS-PYNCHON		- Pince à saisir l'embolus	422	Contenant pour le stockage	
- Tubes d'aspiration	313	BOEHLER		des clips vasculaires	23
ANKENEY		- Pincés coupantes à os	463	CONVERSE	
- Ecarteurs pour sternum	165,166	- Pincés-gouges	456	- Porte-aiguilles	431
Approximateurs	22,24,25	BOROWSKI		COOLEY	
Atraumatique		- Ecarteurs pour l'aorte	179	- Clamps Bulldog	6
- Clamps Bulldog	3-8	BOZEMANN		- Clamps Bulldog, manche à anneau	92-94
- Clamps vasculaires	12,33-113	- Porte-aiguilles	441	- Costotomes	452
- Pincés	122-134	BRAUN-RALPH		- Dilatateurs pour valve mitrale	255
- Pincés polyvalentes	62-66,103-105	- Tubes d'aspiration	315	- Dilatateurs vasculaires	257
- Pincés pour saisir les organes	80	BRAUN-STADLER		- Ecarteurs pour costaux	136,138-140,145
B		- Ciseaux à sternum	347	- Ecarteurs pour oreillette	176,177
BABCOCK		BRIDGE		- Pincés à anastomose	109,111
- Pincés à saisir les intestins		- Pincés hémostatiques	396	- Pincés atraumatiques	126
et les tissus	425,426	BROMPTON		- Pincés atraumatiques polyvalentes	103-105
BABY-ADSON		- Pincés à rouleaux	406	- Pincés pour carotide	113
- Pincés hémostatiques	386	BROPHY		- Pincés pour catheters pour la vena cava	95
BABY-CRILE-WOOD		- Pincés	359	- Pincés pour coarctation	106,107
- Porte-aiguilles	433	BRUNNER		- Pincés pour des nouveaux-nés	
BABY-MOSQUITO		- Costotomes	454	et des enfants	96-102
- Pincés hémostatiques	370	BRUNS		- Pincés pour occlusion tangentielle	112
BABY-OVERHOLT		- Curettes tranchantes	469	- Pincés pour veine iliaque	108
- Pincés à dissection et à ligatures	387	BÜCHS		- Tubes d'aspiration	310,314
BABY-POOLE		- Rugines	475	COOLEY-BECK	
- Tubes d'aspiration	309	BUGGE		- Pincés à anastomose	108
BACKHAUS		- Ecarteur à mammaia	170	COOLEY-DERRA	
- Pincés à champs	408	C		- Pincés à anastomose	110
BADGLEY		CAIRNS		COPE	
- Ecarteur pour laminectomie	149	- Crochets pour nerfs et vaisseaux	248	- Aiguille de biopsie pleurale	320
BAILEY		- Ecarteurs autostatiques	193	CORYLLOS	
- Rapprocheurs pour costaux	172	CAIRNS-DOTT		- Costotomes	451
- Rongeurs pour l'aorte	182	- Pincés	363	- Ecarteurs thoraciques	238
BAILEY-BABY		Canules d'aspiration	313,315-318	Costotomes	448-455
- Rapprocheurs pour costaux	172	Canules veineuses	319	COTTLE	
BAILEY-GIBBON		CASPAR		- Crochets pour nerfs et vaisseaux	248
- Rapprocheurs pour costaux	172	- Micro Dissecteurs	252	CRAFOORD	
BAINBRIDGE		CASTAÑEDA		- Ciseaux Thoraciques	347
- Pincés atraumatiques polyvalentes	62	- Ecarteurs pour costaux	136	- Pincés hémostatiques	393
BALFOUR		- Pincés pour des nouveaux-nés		CRAFOORD SELLORS	
- Ecarteur abdominal	199	et des enfants	88-91	- Pincés hémostatiques	394
				CRAWFORD	
				- Ecarteurs pour l'aorte	180

	page		page		page
CRILE		DE BAKEY-REYNOLDS		FAVOLORO	
- Pincés hémostatiques	372,373	- Pincés à anastomose	53	- Ciseaux artère coronaire	340
CRILE-WOOD		DE BAKEY-RUMEL		FERGUSSON	
- Porte-aiguilles	433	- Pincés à dissection et à ligature	82	- Daviers à os	466
Crochets pour nerfs et vaisseaux	248,249	DE BAKEY-SATINSKY		Fils d'acier à os	486
Curettes tranchantes	468-470	- Pincés pour occlusion tangentielle	79	FINOCHIETTO	
CUSHING		DE BAKEY-SEMB		- Ciseaux à lobectomie	348
- Crochets pour nerfs et vaisseaux	248	- Pincés à dissection et à ligature	83	- Ecarteurs pour costaux	137,140,149,150
- Ecarteurs	209,211	- Pincés pour anéurisme de l'aorte	76	- Pincés pour bronches	417
- Ecarteur à veines	209	DE BAKEY-WHEELER		- Porte-aiguilles	442
- Pincés	359,363	- Pincés atraumatiques	130	FINOCHIETTO-BABY	
- Rongeurs pour l'aorte	183	DERF		- Ecarteurs pour costaux	138
CUSHING-KOCHER		- Porte-aiguilles	431	FINOCHIETTO-BURFORD	
- Ecarteurs	212	DERRA		- Ecarteurs pour costaux	144,151,158
D		- Pincés à anastomose	52	FINSEN	
D'AMICO		DESMARRES		- Ecarteurs autostatiques	188
- Tubes d'aspiration	311	- Ecarteurs	210	FINSTERER	
DALE		DIEFFENBACH		- Tubes d'aspiration	315
- Pincés vasculaires périphériques	57	- Clamps Bulldog	11	FOERSTER	
DANDY		DIETHRICH		- Pincés à pansements	413
- Pincés hémostatiques	383	- Ciseaux vasculaires	339	FOGARTY	
DARDIK		- Clamps Bulldog	3	- Mors interchangeables pour pincés	
- Pincés vasculaires atraumatiques	60,61	- Pincés pour l'aorte	69	vasculaires	116
DARLING		DIETHRICH-HEGEMANN		- Pincés vasculaires pour mors	
- Ecarteurs autostatiques	198	- Ciseaux vasculaires	338	interchangeables	114,115
DAVIDSON		Dilatateurs pour valve mitrale	255	FRAZIER	
- Scapula ecarteur	239	- vasculaires	250,251,257-263	- Canules d'aspiration	318
Daviers à os	466-467	Dissecteurs	253	- Crochets pour nerfs et vaisseaux	248
DAVIS		- vasculaires	265	FREER	
- Elévateurs, Raspatoires	254	DIXON-LOVELACE		- Elévateurs, Raspatoires	254
DEAVER		- Pincés hémostatiques	383	FREER-YASARGIL	
- Spatules abdominales	213,214	DOYEN		- Elévateurs, Raspatoires	254
DE BAKEY		- Rugines pour costaux	479-481	FRTSCH	
- Canules d'aspiration	313	- Sondes	267	- Ecarteurs	231
- Canules veineuses	319	DUBOST		FRYKHOLM	
- Ciseaux compensé	340	- Ecarteurs pour costaux	152	- Pincés-gouges	460
- Ciseaux vasculaires	338	DURANTE		FUCHSIG	
- Clamps Bulldog	4,8	- Pincés	369	- Pincés à dissection et à ligatures	387
- Clamps Bulldog, manche à anneau	38,39	DUVAL		G	
- Clamps vasculaires	12	- Pincés à saisir les intestins et les tissus	427	GARRETT	
- Dilatateurs vasculaires	258,259,261	E		- Dilatateurs vasculaires	260
- Ecarteurs pour costaux	144,154,156	Ecarteur abdominal	199	- Injecteur pour héparine	319
- Pince pour veine iliaque	81	- à mammaire	168,170	GEMINI	
- Pincés à anastomose	52	- à veines	209	- Pincés à dissection et à ligatures	386
- Pincés à anastomoses d'aorte	71	- épicaldial	187	GEMINI mini	
- Pincés à dissection et à ligature	83	- pour laminectomie	149	- Pincés à dissection et à ligatures	387
- Pincés à ligature	85	- vasculaire	199	GERALD	
- Pincés atraumatiques	122-125,127,128,132-134	Ecarteurs	200-206,208-212,215-236,239	- Pincés	364
- Pincés atraumatiques polyvalentes	64,65	- autostatiques	187-199	GIERTZ-STILLE	
- Pincés pour anéurisme de l'aorte	72,74,77	- pour costaux	136-159	- Costotomes	455
- Pincés pour coarctation	42-46	- pour l'aorte	178-180	GILLIES	
- Pincés vasculaires atraumatiques	38,39,64,65	- pour oreillette	176,177	- Crochets pour nerfs et vaisseaux	248
- Pincés vasculaires périphériques	54-56	- pour sternum	162-166	- Pincés	362
- Porte-aiguilles	434,435	- pour vaisseaux	251	- Porte-aiguilles	445
- Tubes d'aspiration	313	- sous forme de selle	208	GIL VERNET	
DE BAKEY-ADSON		- thoraciques	160,237,238	- Ecarteurs sous forme de selle	208
- Pincés atraumatiques	129	ECHLIN		GLASSMAN	
DE BAKEY-BAHNSON		- Pincés-gouges	460	- Pincés atraumatiques	130
- Pincés pour anéurisme de l'aorte	73	EDWARDS		GLOVER	
DE BAKEY-BECK		- Applicateur	117	- Clamps Bulldog	7,8
- Pincés atraumatiques polyvalentes	66	- Clips	117	- Pincés à anastomose	50,51
DE BAKEY-DIETHRICH		Elévateurs	254	GLOVER-DE BAKEY	
- Clamps Bulldog	3	Enlève-lames	303	- Pincés vasculaires atraumatiques	36
- Pincés atraumatiques	127	ETHICON		GLUCK	
DE BAKEY-GERALD		- Clips TITANE à ligature	21	- Costotomes	450
- Pincés atraumatiques	129	- Pincés pour appliquer des clips	20	GREGORY	
DE BAKEY(LAMBERT modif.)		F		- Pincés pour profunda	87
- Pincés à anastomoses d'aorte	71	FARABEUF		GREGORY „SOFT“	
DE BAKEY-MC QUIGG-MIXTER		- Ecarteurs	200	- Clamps Bulldog	5
- Pincés à dissection et à ligature	82	- Rugines	474	GROSS-MAIER	
DE BAKEY-MIXTER		FARABEUF-COLLIN		- Pincés à pansements	411
- Pincés à dissection et à ligature	84	- Rugines	474	GRUENWALD	
DE BAKEY-MORRIS		FRANCAIS		- Pincés	366
- Pincés pour anéurisme de l'aorte	75			GUNNER-HEY	
				- Pincés à rouleaux	406

page	page	page
H		
HABERER		
- Spatules abdominales	207	
HAIGHT		
- Ecarteurs pour costaux	141	
HALSEY		
- Porte-aiguilles	431	
HALSTED-MOSQUITO		
- Pincés hémostatiques	371	
- Pincés vasculaires atraumatiques	34	
HALSTED-MOSQUITO micro		
- Pincés hémostatiques	371	
HARKEN		
- Pincés oreilletas	40,41,422	
HARRINGTON		
- Ecarteurs	217	
- Pincés pour bronches	417	
HARRINGTON-BABY		
- Ecarteurs	217	
HARVEY		
- Ciseaux à couper le fil	492	
- Pincés à couper le fil	494	
HEANEY		
- Porte-aiguilles	440	
HEGAR		
- Dilatateurs vasculaires	262,263	
- Porte-aiguilles vasculaires	437	
HEISS		
- Pincés hémostatiques	385	
HENLEY		
- Ecarteurs autostatiques	190	
HERTZLER		
- I.M.A. Ecarteurs	167	
HIBBS		
- Ecarteurs	237	
HOHENFELLNER		
- Ciseaux vasculaires	344	
HOPT		
- Pincés vasculaires atraumatiques	35	
I		
I.M.A.		
- Ecarteur à mammaia	168	
- Ecarteur épicaldial	187	
- Ecarteurs	167-170	
- Injecteur pour héparine	319	
Injecteur pour héparine	319	
In-situ ciseaux valve veineuse	343	
Instruments pour varices	246,247	
IRIS		
- Ciseaux	333,334	
ISRAEL		
- Ecarteurs	226	
J		
JACOBSON		
- Micro-ciseaux vasculaires	276,277	
- Micro-Porte-aiguilles	286-289	
- Sonde boutonée	251	
JANSEN		
- Ecarteurs autostatiques	189	
- Pincés	366	
- Rugines	473	
JAVID		
- Pincés pour carotide	86	
JEFFERSON		
- Ecarteurs autostatiques	193	
- Pincés	353	
JOHNS-HOPKINS		
- Clamps Bulldog	10	
JONES		
- Pincés à champs	407	
JONES-CLIP		
- Pincés à champs	407	
JORGENSEN		
- Thoraciques ciseaux	348	
JOSEPH		
- Ciseaux	332	
JUDD-ALLIS		
- Pincés à saisir les intestins et les tissus	423	
K		
KADER		
- Ecarteurs	206	
KANTROWITZ		
- Pincés hémostatiques	396	
KARP		
- Rongeurs pour l'aorte	181	
KELLY		
- Ecarteurs	205,235	
- Pincés hémostatiques	372,397	
KILLIAN		
- Élévateurs, Raspatoires	254	
KILNER		
- Ciseaux	332	
KLINKENBERG-LOTH		
- Thoraciques ciseaux	348	
KOCHER		
- Ecarteurs	212,221-223,230,232	
- Pincés hémostatiques	379	
KOCHER-LANGENBECK		
- Ecarteurs	229	
KOCHER-NIPPON		
- Pincés hémostatiques	381	
KOCHER-WAGNER		
- Ecarteurs	233	
KOENIG		
- Ecarteurs	212	
KOERTE		
- Ecarteurs	215	
KRÄMER		
- Rugines	475	
KRAYENBÜHL		
- Crochets pour nerfs et vaisseaux	249	
L		
LAHEY		
- Pincés à peritoine	402	
LAMBERT-KAY		
- Pincés à anastomoses d'aorte	71	
LAMBOTTE		
- Rugines	473	
LANDOLT		
- Manches pour bistouris	307	
LANE		
- Pincés à champs	410	
LANGENBECK		
- Daviers à os	466	
- Ecarteurs	227,228	
- Rugines	475	
LANGENBECK-GREEN		
- Ecarteurs	210	
LAWRENCE		
- Pincés hémostatiques	395	
LAZAR		
- Micro Pincés	296	
LEBSCHÉ		
- Ciseau-burin à sternum	471	
- Costotomes	453	
LEES		
- Pincés pour bronches	37	
LEKSELL		
- Pincés-gouges	459	
LEKSELL-STILLE		
- Pincés-gouges	459	
LELAND-JONES		
- Pincés atraumatiques polyvalentes	63	
LEMMON		
- Rapprocheurs pour costaux	171	
LERICHE		
- Ecarteurs	215	
- Pincés hémostatiques	384	
LEXER		
- Ciseaux à dissection	327	
LEXER-FINO		
- Ciseaux à dissection	326	
LICHTENBERG		
- Porte-aiguilles	444	
LIDDLE		
- Pince pour l'aorte	67	
LISTER		
- Pincés à sinus	415	
LISTON		
- Pincés coupantes à os	462	
LITTAUER		
- Ciseaux à fil	349	
LITTLEWOOD		
- Pincés à saisir les intestins et les tissus	428	
LOCKHART-MUMMERY		
- Sondes	268	
LORNA		
- Pincés à champs	410	
LOVE-GRUENWALD		
- Rongeurs pour l'aorte	183	
LOVELACE		
- Pincés à saisir le poumon	416	
LUCAE		
- Pincés	366	
M		
Maillets	471	
Manches pour bistouris	302-308	
- micro	307-308	
Mandrin	256	
MARQUARDT		
- Pincés-gouges	457	
MARTIN		
- Ecarteurs	236	
- Pincés à pansements	414	
- Spatules abdominales	207	
MARTIN-WYLIE		
- Pincés vasculaires périphériques	58,59	
MATHIEU		
- Porte-aiguilles	443,444	
MATSON		
- Rugines	477	
MATSON ALEXANDER		
- Rugines	476	
MAYO		
- Ciseaux à dissection	325	
MAYO-HEGAR		
- Porte-aiguilles	435	
MAYO-STILLE		
- Ciseaux à dissection	326	
MC INDOE		
- Ciseaux pour cartilage	342	
- Pincés	362	
- Pincés coupantes à os	463	
MC KISSOCK		
- Rugines	475	
MC QUIGG-MIXTER		
- Pincés hémostatiques	401	
MEEKER		
- Pincés hémostatiques	396	
MEHDORN		
- Clips vasculaires	24	
- Pincés à appliquer	26	
MERCEDES		
- Ecarteurs thoraciques	160	
METZENBAUM		
- Ciseaux à dissection	328	
METZENBAUM-FINO		
- Ciseaux à dissection	329,330,331	
METZENBAUM-NELSON		
- Ciseaux à dissection	331	

	page		page		page
Micro		OVERHOLT-GEISSENDOERFER		POPPEL	
- Ciseaux à dissection	274-277	- Pincés à dissection et à ligatures,	389	- Tubes d'aspiration	317
- Ciseaux pour veines	276,277	OVERHOLT-MIXTER		Porte-aiguilles	431-445
- Ciseaux vasculaires	270-277	- Pincés à dissection et à ligatures	391	- micro	278-289
- Clips vasculaires	27	P		- micro-vasculaires	437
- Dissecteurs	247,252			Portes-ligatures	256
- Phleboextracteurs	247	PARKER-LANGENBECK		POTTS	
- Pincés	290-299	- Ecarteurs	202	- Pincés pour coarctation	47-49
- Pincés à anneaux	290,291,295	PEAN		POTTS-DE MARTEL	
- Porte-aiguilles	278-289	- Pincés hémostatiques	378	- Ciseaux vasculaires	337,339
MICRO-ADSON		- Pincés vasculaires atraumatiques	33	POTTS-SMITH	
- Pincés	351	PEAN-NIPPON		- Ciseaux vasculaires	335,337,339
- Pincés hémostatiques	399	- Pincés hémostatiques	380	- Pincés	361
MICRO-ADSON BIEMER		PEERS BERTRAM		POTTS-YASARGIL	
- Pincés	351	- Pincés à champs	408	- Micro-ciseaux vasculaires	276,277
MIDDELDORPF		PENNYBACKER		PRESBYTERIAN HOSPITAL	
- Ecarteurs	202	- Dissecteurs	253	- Pincés serre-tubes	404
MIKULICZ		PERWITZCHKY		PRICE-THOMAS	
- Ecarteurs	234	- Ciseaux	334	- Pincés pour bronches	418
- Pincés à peritoine	403	Pince à saisir la valvule cardiaque	429	PROVIDENCE-HOSPITAL	
MIKULICZ-BABY		Pince à saisir l'embolus	422	- Pincés hémostatiques	373
- Pincés à peritoine	402	Pince pour poser et retirer		R	
MILLES		les clamps Bulldog	10		
- Micro-ciseaux vasculaires	276,277	Pincés	350-369	RAGNELL	
MILLS		- atraumatiques	122-134	- Ecarteurs	203
- Ciseaux vasculaires	337	- micro	290-299	RAMEL	
MISKIMOM		- TITANE	123,125,133,350,352,362,364	- Aiguille de biopsie pleurale	320
- Ecarteurs autostatiques	195	Pincés à anastomoses d'aorte	71	RAMPLEY	
MIXTER		Pincés à appliquer pour		- Pincés à pansements	414
- Pincés hémostatiques	398,400	- ACLAND Clips vasculaires	23	RANKIN	
MIXTER-BABY		- Approximateurs	26	- Pincés hémostatiques	372
- Pincés hémostatiques	399	- Clips à ligature	20	- Pincés vasculaires atraumatiques	34
MIXTER-O'SHAUGNESSY		- Clips anévrismaux	17	Rapprocheurs pour costaux	171,172
- Pincés hémostatiques	400	- Clips vasculaires	26,29,30	Récepteurs métalliques	261
MOCK (DE BAKEY)		- EDWARDS Clips	117	REILL	
- Injecteur pour héparine	319	- Micro Clip vasculaire	27	- Micro-Porte-aiguilles	280-283
Modèle russe, pincés	368	Pincés à champs	407-410	- Pincés à couper le fil	493
Mors interchangeables pour pincés		- à couper le fil	492-495	REYNOLDS	
vasculaires	116	- à dissection		- Ciseaux	333
MORSE		et à ligature	82-84,386-391,415,419	RICHARDSON	
- Ecarteurs pour sternum	162,164	- à ligature	27,85,370	- Ecarteurs	202,204
MORSE-FAVOLORO		- à pansements	411-414	- TITANE	372
- Ecarteurs pour sternum	163	- à peritoine	402	ROBB	
MÜLLER		- à rouleaux	406	- Dissecteurs vasculaires	265
- Approximateurs	25	- à saisir les intestins et les tissus	423-429	ROBERTS	
- Clips vasculaires	27	- à saisir le poumon	416	- Pincés hémostatiques	394
- Crochets pour nerfs et vaisseaux	248	- à sinus	415	ROCHESTER-CARMALT	
- Pince à ligature	27	- à torsader le fil	489-491	- Pincés hémostatiques	383
MURPHY		- coupantes à os	461-465	ROCHESTER-OCHSNER	
- Ecarteurs	224	- coupantes de côté	492-495	- Pincés hémostatiques	376,377
- Pincés serre-tubes	405	- gouges	456-461	ROCHESTER-PEAN	
N		- hémostatiques	370-385,392-401	- Pincés hémostatiques	374,375
		- oreillettas	40,41,422	Rongeurs pour l'aorte	181-183
NABATOFF		- plates	486-489	ROSS	
- Strippers à varices	242	- polyvalentes	62-66,103-105	- Ecarteurs pour l'aorte	178
NEIVERT		- pour anéurisme de l'aorte	72-77	ROUX	
- Porte-aiguilles	432	- pour bronches	37,417-419	- Ecarteurs	200,201
NELSON		- pour carotide	86,113	Rugines	254,471-485
- Pincés	367	- pour catheters	95	- pour costaux	479-481
- Trocarts	321	- pour coarctation	42-49,106,107	RUMEL	
O		- pour des nouveaux-nés		- Pincés hémostatiques	392
		et des enfants	88-91,96-101	RUMEL-BELMONT	
OCHSNER		- pour l'aorte	67-70,108-111	- Tourniquets	256
- Ecarteur vasculaire	199	- pour occlusion tangentielle	78,79,112	RUSKIN	
- Pincés pour l'aorte	69	- pour profunda	87	- Pincés-gouges	457
- Trocarts	321	- pour saisir les organes	80	RUSKIN-LISTON	
OLSEN-HEGAR		- pour veine iliaque	81,108	- Pincés coupantes à os	464
- Porte-aiguilles	445	- serre-tubes	404,405	RYDER	
OPPEL		- vasculaires, flexibles	118-119	- Porte-aiguilles	436
- Micro Dissecteurs	252	- vasculaires périphériques	54-59	- Porte-aiguilles vasculaires	438,439
OVERHOLT		- vasculaires		S	
- Pincés à dissection et à ligatures	390,391	pour mors interchangeables	114,115		
- Rugines	477,478	PLESTER		SANTULLI	
OVERHOLT fino		- Tubes d'aspiration	317	- Clamps Bulldog	5
- Pincés à dissection et à ligatures	390	POOLE		SANVERNO	
		- Tubes d'aspiration	309	- Ciseaux	332

	page		page		page
SAROT		STILLE-LUER		VANNAS	
- Pincés hémostatiques	393	- Pincés-gouges	458	- Micro-ciseaux vasculaires	274-277
- Pincés pour bronches	419	STRATTE		VARADY	
- Porte-aiguilles	442	- Porte-aiguilles	440	- Dissecteur, micro	247
SATINSKY		Strippers à varices	242-245	- Phlebodissecteur	246
- Ciseaux vasculaires	345	STRUCK		- Phleboextracteurs	246,247
- Pincés à anastomose	420,421	- Ecarteurs pour costaux	142	- Phleboextracteurs, micro	247
- Pincés pour occlusion tangentielle	78	STRULLY		- Strippers à varices	243
SAUERBRUCH		- Ciseaux vasculaires	341	WISE	
- Costotomes	453	SUBRAMANIAN		- Micro Pincés	297
- Ecarteurs	239	- Pincés pour l'aorte	68	VOLKMAN	
- Pincés-gouges	459	SUBRAMANIAN MINIATURE		- Curettes tranchantes	470
SAUERBRUCH-FREY		- Pincés pour l'aorte	68	- Ecarteurs	218-220,225
- Costotomes	454	SUPERCUT ciseaux	322-324,327-329,337	W	
Scapula ecarteur	239	Système de clips anévrismaux	13-19	WALTON-YANKAUER	
SCHAEDEL		- Contenants	18-19	- Tubes d'aspiration	312
- Pincés à champs	407	- Clips MINI	15,16	WANGENSTEEN	
SCHEDÉ		- Clips PHYNOX	13-16	- Pincés	367
- Curettes tranchantes	468	- Clips STANDARD	13,14	- Porte-aiguilles	441
SCHÉIBÉ		- Clips TITANE	13-16	WAUGH	
- Pincés à saisir les intestins et les tissus	428	- Pincés à appliquer	17	- Pincés	365
SCHMID		T		WEBER	
- Aiguilles vasculaires pour irrigation	316	TEALE		- Pincés pour l'aorte	70
- Spatules pour intima	266	- Pince à saisir la valvule cardiaque	429	WEBSTER	
SCHNIDT		TESSIER		- Porte-aiguilles	432
- Pincés à dissection et à ligature	415	- Ecarteurs thoraciques	237	WEINBERG	
SCHOENBORN		THOMS-ALLIS		- Ecarteurs pour costaux	139
- Ecarteurs	209	- Pincés à saisir les intestins et les tissus	424	WEITLANER	
SCHUMACHER		THOREK		- Ecarteurs autostatiques	191,192
- Ciseaux à sternum	449	- Ciseaux Thoraciques	346	WEITLANER-BECKMANN	
SCHWARTZ		TITANE		- Ecarteurs autostatiques	196
- Clips vasculaires	30	- Clamps vasculaires	2	WICKSTROEM	
- Pince à appliquer pour clips vasculaires	30	- Clips à ligature	21	- Ciseaux hémostatiques	401
SELLORS		- Clips anévrismaux	13-16	WILLAUER	
- Rapprocheurs pour costaux	171	- Pincés	123,125,133,350,352,362,364	- Ciseaux Thoraciques	346
SELMAN		- Pincés à anastomose	50-52,108	WILLIAMS	
- Pincés	368	- Pincés à anastomoses d'aorte	71,72	- Pincés à saisir les intestins et les tissus	429
SEMB		- Pincés atraumatiques polyvalentes	63,65,66	WOLF	
- Daviers à os	467	- Pincés hémostatiques	372	- Tubes d'aspiration	311
- Pincés à dissection et à ligature	419	- Pincés pour anévrisme de l'aorte	76	WYLIE	
- Pincés coupantes à os	465	- Pincés pour bronches	37	- Pincés vasculaires atraumatiques	36
- Pincés-gouges	460	- Pincés pour carotide	113	Y	
- Rugines	482,483	- Pincés pour coarctation	47,106,107	YANKAUER	
- Spatules pulmonaires	175	- Pincés pour l'aorte	68	- Tubes d'aspiration	312
SEMKEN		- Pincés pour occlusion tangentielle	78	YANKAUER-BABY	
- Pincés	350	- Pincés pour veine iliaque	108	- Tubes d'aspiration	312
SENN-MILLER		- Pincés vasculaires périphériques	56	YASARGIL	
- Ecarteurs	203	TOENNIS		- Micro-ciseaux vasculaires	276,277
SHUNT		- Crochets pour nerfs et vaisseaux	248	- Micro Clip vasculaire	27
- Clamps Bulldog	9	- Dissecteurs	253	- Micro Dissecteurs	252
SIMON		- Porte-aiguilles	443	- Pince à appliquer pour les clips vasculaires	27
- Ecarteurs	236	TOENNIS-ADSON		- Pincés à appliquer pour les clips anévrismaux	17
SINGLEY-TUTTLE		- Ciseaux vasculaires	341	- Système de clips anévrismaux	13-19
- Pincés	369	TOHOKU		Z	
SMITH-PETERSEN		- Pincés à champs	409	ZANGER	
- Pincés-gouges	461	Tourmiquets	256	- Injecteur pour héparine	319
Sonde boutonée	251	Trocarts	321	ZAUFAL-JANSEN	
Sondes	267,268	TUBBS		- Pincés-gouges	456
Spatules abdominales	207,213,214	- Dilatateurs pour valve mitrale	255	ZENKER	
- pour intima	266	Tubes d'aspiration	309-317	- Ecarteurs	216
- pulmonaires	175,239	TUFFIER		- Pincés hémostatiques	395
SPENCER		- Ecarteurs pour costaux	148	U	
- Ciseaux à fil	349	Tunnelisation, Jeu pour	264	ULRICH	
SPENCER-WELLS		U		- Pincés à pansements	412
- Pincés hémostatiques	382	US ARMY (PARKER-LANGENBECK)		V	
SPURLING		- Ecarteurs	202	VANDERBILT	
- Rongeurs pour l'aorte	183	V		- Pincés hémostatiques	392
STANDARD		V			
- Ciseaux	322-324				
- Pincés	354,356,358				
- Pincés pour appliquer des clips à ligature	20				
STILLE					
- Costotomes	450				
STILLE-HORSLEY					
- Pincés coupantes à os	465				
STILLE-LISTON					
- Pincés coupantes à os	464,465				

página

A

ABRAMS	
- Aguja de la biopsia pleural	320
ACLAND	
- Aproximadores	22
- Clips dobles	22
- Clips singulares	22
- Clips vasculares	22
- Pinzas para aplicar	23
ADSON	
- Cánulas para aspiración	316
- Periostótomos	472
- Pinzas	352,353,366
- Pinzas hemostáticas	385
- Separadores autoestáticos	197
ADSON-BABY	
- Separadores autoestáticos	193
Aguja de la biopsia pleural	320
ALEXANDER	
- Periostótomos	476
Alicates de pico plano	486-489
Alicates para cortar alambre	492-495
ALLIS	
- Pinzas para coger intestinos y tejidos.....	423,424
ALLIS-BABY	
- Pinzas para coger intestinos y tejidos	423
ALLISON	
- Espátulas pulmonares	175
ALLPORT	
- Separadores autoestáticos	189
ALM	
- Separadores autoestáticos	189
ANDERSON-ADSON	
- Separadores autoestáticos	195
ANDREWS-PYNCHON	
- Tubos de aspiración	313
ANKENEY	
- Separadores para esternón	165,166
Aproximadores	22,24,25
- para costillas	171,172
Atraumáticas	
- Clamps Bulldog	3-8
- Clamps vasculares	12,33-113
- Pinzas	122-134
- Pinzas clamps atraumáticas	62-66,103-105
- Pinzas para sacar órganos	80

B

BABCOCK	
- Pinzas para coger intestinos y tejidos.....	425,426
BABY-ADSON	
- Pinzas hemostáticas	386
BABY-CRILE-WOOD	
- Porta-agujas	433
BABY-MOSQUITO	
- Pinzas hemostáticas	370
BABY-OVERHOLT	
- Pinzas para disección y ligaduras	387
BABY-POOLE	
- Tubos de aspiración	309
BACKHAUS	
- Pinzas para campos	408
BADGLEY	
- Separador para laminectomía	149
BAILEY	
- Aproximadores para costillas	172
- Perforadores aórticos	182
BAILEY-BABY	
- Aproximadores para costillas	172
BAILEY-GIBBON	
- Aproximadores para costillas	172
BAINBRIDGE	
- Pinzas clamps atraumáticas	62
BALFOUR	
- Separador abdominal	199

BARRAQUER

- Micro-Porta-agujas	280,282
BAUMGARTNER	
- Pinzas para torcer alambre	490
- Porta-agujas	432
BEAL	
- Circumflex tijeras	335
BECK	
- Pinzas clamps atraumáticas	66
BECKMANN	
- Separadores autoestáticos	196
BECKMANN-ADSON	
- Separadores autoestáticos	194
BECKMANN-EATON	
- Separadores autoestáticos	194
BENGOLEA	
- Pinzas hemostáticas	384
BERLIN	
- Pinzas cierra-tubos	404
BERRY	
- Pinzas para torcer alambre	491
BETHUNE	
- Costótomos	452
BEYER	
- Pinzas-gubias	456
BIEMER	
- Aproximadores	24
- Aproximadores para nervios	24
- Clips vasculares	24
- Pinzas para aplicar	26
- Separadores para vasos	251
- Tijeras para venas	276,277
BIEMER-MÜLLER	
- Aproximadores	25
BLAKE	
- Pinza para coger émbolo	422
Bocas para pinzas vasculares	116
BOEHLER	
- Pinzas cortantes para huesos	463
- Pinzas-gubias	456
BOROWSKI	
- Separadores para aorta	179
BOZEMANN	
- Porta-agujas	441
BRAUN-RALPH	
- Tubos de aspiración	315
BRAUN-STADLER	
- Tijera de esternón	347
BRIDGE	
- Pinzas hemostáticas	396
BROMPTON	
- Pinzas con rodillo	406
BROPHY	
- Pinzas	359
BRUNNER	
- Costótomos	454
BRUNS	
- Cucharillas cortantes	469
BÜCHS	
- Periostótomos	475
BUGGE	
- Separador mamaria	170

C

CAIRNS	
- Ganchos para nervios y vasos	248
- Separadores autoestáticos	193
CAIRNS-DOTT	
- Pinzas	363
Cánulas para aspiración	313,315-318
- para venas	319
- vasculares para irrigación	316,319
CASPAR	
- Micro Disecadores	252
CASTAÑEDA	
- Pinzas clamps para recién nacidos y niños	88-91

página

- Separadores costales	136
CASTROVIEJO	
- Micro-Porta-agujas	286-289
CHITWOOD-DE BAKEY	
- Pinzas atraumáticas	131
Cinzel para esternón	471
Clamps Bulldog	3-11
- con mango de anillo	38,39,92-94
Clamps vasculares	12
- TITANIO	2
Clips	
- Sistema de clips de aneurisma	13-16
- vasculares	22,24,27,28,30
Clips de TITANIO para ligadura	21
COLLIN	
- Costótomos	450
CONE	
- Separadores autoestáticos	197
Contenedor	
- para clips de aneurisma	18,19
- para el almacenamiento de los clips vasculares	23
CONVERSE	
- Porta-agujas	431
COOLEY	
- Clamps Bulldog	6
- Clamps Bulldog con mango de anillo	92-94
- Costótomos	452
- Dilatadores para válvula mitral	255
- Dilatadores vasculares	257
- Pinzas atraumáticas	126
- Pinzas clamps para iliaca	108
- Pinzas clamps para recién nacidos y niños	96-102
- Pinzas clamps para usos varios	103-105
- Pinzas para anastomosis	109,111
- Pinzas para carótido	113
- Pinzas para catéteres	95
- Pinzas para coarctación	106,107
- Pinzas para oclusión tangencial	112
- Separadores atrium	176,177
- Separadores costales	136,138,139,140,145
- Tubos de aspiración	310,314
COOLEY-BECK	
- Pinzas para anastomosis	108
COOLEY-DERRA	
- Pinzas para anastomosis	110
COPE	
- Aguja de la biopsia pleural	320
CORYLLOS	
- Costótomos	451
- Separadores torácicos	238
Costótomos	448-455
COTTLE	
- Ganchos para nervios y vasos	248
CRAFOORD	
- Pinzas hemostáticas	393
- Tijeras torácicas	347
CRAFOORD SELLORS	
- Pinzas hemostáticas	394
CRAWFORD	
- Separadores para aorta	180
CRILE	
- Pinzas hemostáticas	372,373
CRILE-WOOD	
- Porta-agujas	433
Cucharillas cortantes	468-470
CUSHING	
- Gancho para venas	209
- Ganchos para nervios y vasos	248
- Perforadores aórticos	183
- Pinzas	359,363
- Separadores	209,211
CUSHING-KOCHER	
- Separadores	212

página

	página
D	
D'AMICO	
- Tubos de aspiración	311
DALE	
- Pinzas para vasos periféricos	57
DANDY	
- Pinzas hemostáticas	383
DARDIK	
- Pinzas clamps atraumáticas	60,61
DARLING	
- Separadores autoestáticos	198
DAVIDSON	
- Scapula separador	239
DAVIS	
- Elevadores, Perióstótomos	254
DEAVER	
- Espátulas abdominales	213,214
DE BAKEY	
- Cánulas para aspiración	313
- Cánulas para venas	319
- Clamps Bulldog	4,8
- Clamps Bulldog con mango de anillo	38,39
- Clamps vasculares	12
- Dilatadores vasculares	258,259,261
- Pinzas atraumáticas	122-125,127,128,132-134
- Pinzas clamps atraumáticas	64,65
- Pinzas clamps para anastomosis de aorta	71
- Pinzas clamps para aneurisma de aorta	72,74,77
- Pinzas clamps para iliaca	81
- Pinzas de disección y para ligaduras	83
- Pinzas para anastomosis	52
- Pinzas para coarctación	42-46
- Pinzas para ligaduras	85
- Pinzas para vasos periféricos	54-56
- Pinzas vasculares atraumáticas	38,39,64,65
- Porta-agujas	434,435
- Separadores costales	144,154,156
- Tijeras compensar	340
- Tijeras vasculares	338
- Tubos de aspiración	313
DE BAKEY-ADSON	
- Pinzas atraumáticas	129
DE BAKEY-BAHNSON	
- Pinzas clamps para aneurisma de aorta	73
DE BAKEY-BECK	
- Pinzas clamps atraumáticas	66
DE BAKEY-DIETHRICH	
- Clamps Bulldog	3
- Pinzas atraumáticas	127
DE BAKEY-GERALD	
- Pinzas atraumáticas	129
DE BAKEY(LAMBERT modif.)	
- Pinzas clamps para anastomosis de aorta	71
DE BAKEY-MC QUIGG-MIXTER	
- Pinzas de disección y para ligaduras	82
DE BAKEY-MIXTER	
- Pinzas de disección y para ligaduras	84
DE BAKEY-MORRIS	
- Pinzas clamps para anastomosis de aorta	75
DE BAKEY-REYNOLDS	
- Pinzas para anastomosis	53
DE BAKEY-RUMEL	
- Pinzas de disección y para ligaduras	82
DE BAKEY-SATINSKY	
- Pinzas para oclusión tangencial	79
DE BAKEY-SEMB	
- Pinzas clamps para aneurisma de aorta	76
- Pinzas de disección y para ligaduras	83
DE BAKEY-WHEELER	
- Pinzas atraumáticas	130
DERF	
- Porta-agujas	431
DERRA	
- Pinzas para anastomosis	52

	página
DESMARRES	
- Separadores	210
DIEFFENBACH	
- Clamps Bulldog	11
DIETHRICH	
- Clamps Bulldog	3
- Pinzas clamps para aorta	69
- Tijeras vasculares	339
DIETHRICH-HEGEMANN	
- Tijeras vasculares	338
Dilatadores	
- para válvula mitral	255
- para vasos	250,251,257-263
Disecadores	
- vasculares	253
- vasculares	265
DIXON-LOVELACE	
- Pinzas hemostáticas	383
DOYEN	
- Legras costales	479-481
- Sondas	267
DUBOST	
- Separadores costales	152
DURANTE	
- Pinzas	369
DUVAL	
- Pinzas para coger intestinos y tejidos	427
E	
ECHLIN	
- Pinzas-gubias	460
EDWARDS	
- Clips	117
- Pinza para aplicar	117
Elevadores	
- costales	254
Espátulas	
- abdominales	207,213,214
- íntimas	266
- pulmonares	175,239
ETHICON	
- Clips de TITANIO para ligadura	21
- Pinzas para aplicar	20
F	
FARABEUF	
- Perióstótomos	474
- Separadores	200
FARABEUF-COLLIN	
- Perióstótomos	474
FAVOLORO	
- Tijeras de la arteria coronaria	340
FERGUSSON	
- Pinzas para huesos	466
FINOCHIETTO	
- Pinzas clamps bronquiales	417
- Porta-agujas	442
- Separadores costales	137,140,149,150
- Tijera para lobectomía	348
FINOCHIETTO-BABY	
- Separadores costales	138
FINOCHIETTO-BURFORD	
- Separadores costales	144,151,158
FINSEN	
- Separadores autoestáticos	188
FINSTNERER	
- Tubos de aspiración	315
FOERSTER	
- Pinzas para torundas	413
FOGARTY	
- Bocas para pinzas vasculares	116
- Pinzas vasculares para bocas intercambiables	114,115
FRAZIER	
- Cánulas para aspiración	318
- Ganchos para nervios y vasos	248
FREER	
- Elevadores, Perióstótomos	254

	página
FREER-YASARGIL	
- Elevadores, Perióstótomos	254
FRITSCH	
- Separadores	231
FRYKHOLM	
- Pinzas-gubias	460
FUCHSIG	
- Pinzas para disección y ligaduras	387
G	
Gancho para venas	209
Ganchos en forma de silla	208
Ganchos para nervios y vasos	248,249
GARRETT	
- Dilatadores vasculares	260
- Inyector para heparin	319
GEMINI	
- Pinzas para disección y ligaduras	386
GEMINI mini	
- Pinzas para disección y ligaduras	387
GERALD	
- Pinzas	364
GIERTZ-STILLE	
- Costótomos	455
GILLIES	
- Ganchos para nervios y vasos	248
- Pinzas	362
- Porta-agujas	445
GIL VERNET	
- Ganchos en forma de silla	208
GLASSMAN	
- Pinzas atraumáticas	130
GLOVER	
- Clamps Bulldog	7,8
- Pinzas para anastomosis	50,51
GLOVER-DE BAKEY	
- Pinzas vasculares atraumáticas	36
GLUCK	
- Costótomos	450
GREGORY	
- Pinzas clamps para profunda	87
GREGORY „SOFT“	
- Clamps Bulldog	5
GROSS-MAIER	
- Pinzas para torundas	411
GRUENWALD	
- Pinzas	366
GUNNER-HEY	
- Pinzas con rodillo	406
H	
HABERER	
- Espátulas abdominales	207
HAIGHT	
- Separadores costales	141
HALSEY	
- Porta-agujas	431
HALSTED-MOSQUITO	
- Pinzas hemostáticas	371
- Pinzas vasculares atraumáticas	34
HALSTED-MOSQUITO micro	
- Pinzas hemostáticas	371
HARKEN	
- Pinzas para aurícula	40,41,422
HARRINGTON	
- Pinzas clamps bronquiales	417
- Separadores	217
HARRINGTON-BABY	
- Separadores	217
HARVEY	
- Alicates para cortar alambre	494
- Tijeras para cortar alambre	492
HEANEY	
- Porta-agujas	440

	página		página		página
HEGAR		KOCHER		LOVE-GRUENWALD	
- Dilataadores vasculares	262,263	- Pinzas hemostáticas	379	- Perforadores aórticos	183
- Porta-agujas vasculares	437	- Separadores	212,221-223,230,232	LOVELACE	
HEISS		KOCHER-LANGENBECK		- Pinzas para coger el pulmón	416
- Pinzas hemostáticas	385	- Separadores	229	LUCAE	
HENLEY		KOCHER-NIPPON		- Pinzas	366
- Separadores autoestáticos	190	- Pinzas hemostáticas	381	M	
HERTZLER		KOCHER-WAGNER		Mandril	256
- I.M.A Separadores	167	- Separadores	233	Mangos de bisturíes	302-308
HIBBS		KOENIG		- micro	307-308
- Separadores	237	- Separadores	212	MARQUARDT	
Hilo para huesos	486	KOERTE		- Pinzas-gubias	457
HOHENFELLNER		- Separadores	215	Martillos	471
- Tijeras vasculares	344	KRÄMER		MARTIN	
HOPT		- Periostótomos	475	- Espátulas abdominales	207
- Pinzas vasculares atraumáticas	35	KRAYENBÜHL		- Pinzas para torundas	414
I		- Ganchos para nervios y vasos	249	- Separadores	236
I.M.A.		L		MARTIN-WYLIE	
- Inyector para heparin	319	LAHEY		- Pinzas para vasos periféricos	58,59
- Separador mammaria	168	- Pinzas para peritoneo	402	MATHIEU	
- Separadores	167-170	LAMBERT-KAY		- Porta-agujas	443,444
- Separadores epicardiacos	187	- Pinzas clamps para anastomosis de aorta	71	MATSON	
Inyector para heparin	319	LAMBOTTE		- Periostótomos	477
In-situ tijeras de la válvula venosa	343	- Periostótomos	473	MATSON ALEXANDER	
Instrumentos para varices	246,247	LANDOLT		- Periostótomos	476
IRIS		- Mangos de bisturíes	307	MAYO	
- Tijeras	333,334	LANE		- Tijeras de disección	325
ISRAEL		- Pinzas para campos	410	MAYO-HEGAR	
- Separadores	226	LANGENBECK		- Porta-agujas	435
J		- Periostótomos	475	MAYO-STILLE	
JACOBSON		- Pinzas para huesos	466	- Tijeras de disección	326
- Micro-Porta-agujas	286-289	- Separadores	227,228	MC INDOE	
- Sonda abotonada	251	LANGENBECK-GREEN		- Pinzas	362
- Tijeras microquirúrgicas vasculares	276,277	- Separadores	210	- Pinzas cortantes para huesos	463
JANSEN		LAWRENCE		- Tijera para cartilago	342
- Periostótomos	473	- Pinzas hemostáticas	395	MC KISSOCK	
- Pinzas	366	LAZAR		- Periostótomos	475
- Separadores autoestáticos	189	- Micro Pinzas	296	MC QUIGG-MIXTER	
JAVID		LEBSCHÉ		- Pinzas hemostáticas	401
- Pinzas para carótido	86	- Cíncel para esternón	471	MEEKER	
JEFFERSON		- Costótomos	453	- Pinzas hemostáticas	396
- Pinzas	352,353	LEES		MEHDORN	
- Separadores autoestáticos	193	- Pinzas clamps bronquiales	37	- Clips vasculares	24
JOHNS-HOPKINS		Legras costales	479-481	- Pinzas para aplicar	26
- Clamps Bulldog	10	LEKSELL		MERCEDES	
JONES		- Pinzas-gubias	459	- Retractor torácico	160
- Pinzas para campos	407	LEKSELL-STILLE		METZENBAUM	
JONES-CLIP		- Pinzas-gubias	459	- Tijeras de disección	328
- Pinzas para campos	407	LELAND-JONES		METZENBAUM-FINO	
JORGENSEN		- Pinzas clamps atraumáticas	63	- Tijeras de disección	329,330,331
- Tijeras torácicas	348	LEMMON		METZENBAUM-NELSON	
JOSEPH		- Aproximadores para costillas	171	- Tijeras de disección	331
- Tijeras	332	LERICHE		Micro	
JUDD-ALLIS		- Pinzas hemostáticas	384	- Clips vasculares	27
- Pinzas para coger intestinos y tejidos	423	- Separadores	215	- Discadores	247,252
K		LEXER		- Fleboextractor	247
KADER		- Tijeras de disección	327	- Pinzas	290-299
- Separadores	206	LEXER-FINO		- Pinzas con anillos	290,291,295
KANTROWITZ		- Tijeras de disección	326	- Porta-agujas	278-289
- Pinzas hemostáticas	396	LICHTENBERG		- Tijeras de disección	274-277
KARP		- Porta-agujas	444	- Tijeras para venas	276,277
- Perforadores aórticos	181	LIDDLE		- Tijeras vasculares	270-277
KELLY		- Pinzas clamps para aorta	67	MICRO-ADSON	
- Pinzas hemostáticas	372,397	LISTER		- Pinzas	351
- Separadores	205,235	- Pinzas para seno	415	- Pinzas hemostáticas	399
KILLIAN		LISTON		MICRO-ADSON BIEMER	
- Elevadores, Periostótomos	254	- Pinzas cortantes para huesos	462	- Pinzas	351
KILNER		LITTAUER		Micro-vascular porta-agujas	437
- Tijeras	332	- Tijeras para hilos	349	MIDDELDORPF	
KLINKENBERG-LOTH		LITTLEWOOD		- Separadores	202
- Tijeras torácicas	348	- Pinzas para coger intestinos y tejidos	428	MIKULICZ	
		LOCKHART-MUMMERY		- Pinzas para peritoneo	403
		- Sondas	268	- Separadores	234
		LORNA		MIKULICZ-BABY	
		- Pinzas para campos	410	- Pinzas para peritoneo	402

	página
MILLESI	
- Tijeras microquirúrgicas vasculares	276,277
MILLS	
- Tijeras vasculares	337
MISKIMOM	
- Separadores autoestáticos	195
MIXTER	
- Pinzas hemostáticas	398,400
MIXTER-BABY	
- Pinzas hemostáticas	399
MIXTER-O'SHAUGNESSY	
- Pinzas hemostáticas	400
MOCK (DE BAKERY)	
- Inyector para heparin	319
Modelo ruso, pinza	368
MORSE	
- Separadores para esternón	162,164
MORSE-FAVOLORO	
- Separadores para esternón	163
MÜLLER	
- Aproximadores	25
- Clips vasculares	27
- Ganchos para nervios y vasos	248
- Pinza para ligadura	27
MURPHY	
- Pinzas cierra-tubos	405
- Separadores	224
N	
NABATOFF	
- Sondas para várices	242
NEIVERT	
- Porta-agujas	432
NELSON	
- Pinzas	367
- Trócares	321
O	
OCHSNER	
- Pinzas clamps para aorta	69
- Separador vascular	199
- Trócares	321
OLSEN-HEGAR	
- Porta-agujas	445
OPPEL	
- Micro Disecadores	252
OVERHOLT	
- Periostótomos	477,478
- Pinzas para disección y ligaduras	390,391
OVERHOLT fino	
- Pinzas para disección y ligaduras	390
OVERHOLT-GEISSENDOERFER	
- Pinzas para disección y ligaduras	388,389
OVERHOLT-MIXTER	
- Pinzas para disección y ligaduras	391
P	
PARKER-LANGENBECK	
- Separadores	202
PEAN	
- Pinzas hemostáticas	378
- Pinzas vasculares atraumáticas	33
PEAN-NIPPON	
- Pinzas hemostáticas	380
PEERS BERTRAM	
- Pinzas para campos	408
PENNYBACKER	
- Disecador	253
Perforadores aórticos	181-183
Periostótomos	254,471-485
PERWITZCHKY	
- Tijeras	334
Pinza de corazón-válvula	429
Pinza para coger émbolo	422
Pinza para ligadura	27,85, 370

	página
Pinza para poner y quitar clamps Bulldog	10
Pinzas	350-369
- atraumáticas	122-134
- Micro	290-299
- TITANIO	123,125,133,350,352,362,364
Pinzas cierra-tubos	404,405
Pinzas clamps	62-66,103-105
Pinzas clamps bronquiales	37,417-419
Pinzas clamps para anastomosis de aorta	71
Pinzas clamps para aneurisma de aorta	72-77
Pinzas clamps para aorta	67-70,108-111
Pinzas clamps para iliaca	81,108
Pinzas clamps para profunda	87
Pinzas clamps para recién nacidos y niños	88-91,96-101
Pinzas con rodillo	406
Pinzas cortantes para huesos	461-465
Pinzas de disección y para ligaduras	82-84,386-391,415,419
Pinzas-gubias	456-461
Pinzas hemostáticas	370-385,392-401
- TITANIO	372
Pinzas para anastomosis	50-53,108-111,420,421
Pinzas para aplicar	
- ACLAND Clips vasculares	23
- Aproximadores	26
- Clips de aneurisma	17
- Clips para ligadura	20
- Clips vasculares	26,29, 30
- EDWARDS Clips	117
- Micro Clip vascular	27
Pinzas para aurícula	40,41,422
Pinzas para campos	407-410
Pinzas para carótido	86,113
Pinzas para catéteres	95
Pinzas para coarctación	42-49,106,107
Pinzas para coger el pulmón	416
Pinzas para coger intestinos y tejidos	423-429
Pinzas para huesos	466-467
Pinzas para oclusión tangencial	78,79,112
Pinzas para peritoneo	402
Pinzas para sacar órganos	80
Pinzas para seno	415
Pinzas para torcer alambre	489-491
Pinzas para torundas	411-414
Pinzas para vasos periféricos	54-59
Pinzas vasculares flexibles	118-119
Pinzas vasculares para bocas intercambiables	114,115
PLESTER	
- Tubos de aspiración	317
POOLE	
- Tubos de aspiración	309
POPPEL	
- Tubos de aspiración	317
Porta-agujas	431-445
Porta-agujas, micro	278-289
Porta ligaduras	256
POTTS	
- Pinzas para coarctación	47-49
POTTS-DE MARTEL	
- Tijeras vasculares	337,339
POTTS-SMITH	
- Pinzas	361
- Tijeras vasculares	335,337,339
POTTS-YASARGIL	
- Tijeras microquirúrgicas vasculares	276,277
PRESBYTERIAN HOSPITAL	
- Pinzas cierra-tubos	404
PRICE-THOMAS	
- Pinzas clamps bronquiales	418
PROVIDENCE-HOSPITAL	
- Pinzas hemostáticas	373
Q	
Quita hojas	303

	página
R	
RAGNELL	
- Separadores	203
RAMEL	
- Aguja de la biopsia pleural	320
RAMPLEY	
- Pinzas para torundas	414
RANKIN	
- Pinzas hemostáticas	372
- Pinzas vasculares atraumáticas	34
Recipiente metálico	261
REILL	
- Alicates para cortar alambre	493
- Micro-Porta-agujas	280-283
Retractor torácico	160
REYNOLDS	
- Tijeras	333
RICHARDSON	
- Separadores	202,204
ROBB	
- Disecadores vasculares	265
ROBERTS	
- Pinzas hemostáticas	394
ROCHESTER-CARMALT	
- Pinzas hemostáticas	383
ROCHESTER-OCHSNER	
- Pinzas hemostáticas	376,377
ROCHESTER-PEAN	
- Pinzas hemostáticas	374,375
ROSS	
- Separadores para aorta	178
ROUX	
- Separadores	200,201
RUMEL	
- Pinzas hemostáticas	392
RUMEL-BELMONT	
- Torniquetes	256
RUSKIN	
- Pinzas-gubias	457
RUSKIN-LISTON	
- Pinzas cortantes para huesos	464
RYDER	
- Porta-agujas	436
- Porta-agujas vasculares	438,439
S	
SANTULLI	
- Clamps Bulldog	5
SANVERNO	
- Tijeras	332
SAROT	
- Pinzas clamps bronquiales	419
- Pinzas hemostáticas	393
- Porta-agujas	442
SATINSKY	
- Pinzas clamps para anastomosis	420,421
- Pinzas para oclusión tangencial	78
- Tijeras vasculares	345
SAUERBRUCH	
- Costótomos	453
- Pinzas-gubias	459
- Separadores	239
SAUERBRUCH-FREY	
- Costótomos	454
Scapula separador	239
SCHAEDEL	
- Pinzas para campos	407
SCHUDE	
- Cucharillas cortantes	468
SCHIEBE	
- Pinzas para coger intestinos y tejidos	428
SCHMID	
- Cánulas vasculares para irrigación	316
- Espátulas íntimas	266
SCHNIDT	
- Pinzas para disección y ligaduras	415

	página
SCHOENBORN	
- Separadores	209
SCHUMACHER	
- Tijera de esternón	449
SCHWARTZ	
- Clips vasculares	30
- Pinza para aplicar clips vasculares	30
SELLORS	
- Aproximadores para costillas	171
SELMAN	
- Pinzas	368
SEMB	
- Espátulas pulmonares	175
- Periostótomos	482,483
- Pinzas cortantes para huesos	465
- Pinzas-gubias	460
- Pinzas para disección y ligaduras	419
- Pinzas para huesos	467
SEMKEN	
- Pinzas	350
SENN-MILLER	
- Separadores	203
Separador abdominal	199
- mamaria	68,170
- para laminectomía	149
- vascular	199
Separadores	200-206,208-212,215-236,239
- atrium	176,177
- autoestáticos	187-199
- costales	136-159
- epicardiacos	187
- para aorta	178-180
- para esternón	162-166
- para vasos	251
- torácicos	237,238
SHUNT	
- Clamps Bulldog	9
SIMON	
- Separadores	236
SINGLEY-TUTTLE	
- Pinzas	369
Sistema de clips de aneurisma	13-19
- Clip contenedores	18-19
- MINI clips	15,16
- PHYNOX clips	13-16
- Pinzas para aplicar	17
- STANDARD clips	13,14
- TITANIO clips	13-16
SMITH-PETERSEN	
- Pinzas-gubias	461
Sonda abotonada	251
Sondas	267,268
Sondas para varices	242-245
SPENCER	
- Tijeras para hilos	349
SPENCER-WELLS	
- Pinzas hemostáticas	382
SPURLING	
- Perforadores aórticos	183
STANDARD	
- Pinzas	354,356,358
- Pinzas para aplicar clips para ligadura	20
- Tijeras	322-324
STILLE	
- Costótomos	450
STILLE-HORSLEY	
- Pinzas cortantes para huesos	465
STILLE-LISTON	
- Pinzas cortantes para huesos	464,465
STILLE-LUER	
- Pinzas-gubias	458
STRAITTE	
- Porta-agujas	440
STRUCK	
- Separadores costales	142
STRULLY	
- Tijeras vasculares	341
SUBRAMANIAN	
- Pinzas clamps para aorta	68

	página
SUBRAMANIAN MINIATURE	
- Pinzas clamps para aorta	68
SUPERCUT tijeras	322-324,327-329,337
T	
TEALE	
- Pinza de corazón-válvula	429
Tenazas de corte lateral	492-495
TESSIER	
- Separadores torácicos	237
THOMS-ALLIS	
- Pinzas para coger intestinos y tejidos	424
THOREK	
- Tijeras torácicas	346
Tijera	
- para cartilago	342
- para lobectomía	348
- para venas	276,277
Tijeras	322-349
- compensar	340
- de disección	325-331
- de esternón	347
- de la arteria coronaria	340
- In-situ de la válvula venosa	343
- micro	270-277
- para cartilago	342
- para cirugía	322-324
- para hilos	349
- para lobectomía	348
- para preparación del nervio	342
- SUPERCUT	322-324,327-329,337
- torácicas	346-348
- vasculares	335-345
TITAN	
- Clamps vasculares	2
- Clips de aneurisma	13-16
- Clips para ligadura	21
- Pinza clamp para iliaca	108
- Pinzas	123,125,133,350,352,362,364
- Pinzas clamps atraumáticas	63,65,66
- Pinzas clamps bronquiales	37
- Pinzas clamps para anastomosis de aorta	71,72
- Pinzas clamps para aneurisma de aorta	76
- Pinzas clamps para aorta	68
- Pinzas hemostáticas	372
- Pinzas para anastomosis	50-52,108
- Pinzas para carótido	113
- Pinzas para coarctación	47,106,107
- Pinzas para oclusión tangencial	78
- Pinzas para vasos periféricos	56
TOENNIS	
- Disecadores	253
- Ganchos para nervios y vasos	248
- Porta-agujas	443
TOENNIS-ADSON	
- Tijeras vasculares	341
TOHOKU	
- Pinzas para campos	409
Torniquetes	256
Trocars	321
TUBBS	
- Dilatadores para válvula mitral	255
Tubos de aspiración	309-317
TUFFIER	
- Separadores costales	148
Tunelización, Juego de	264
U	
ULRICH	
- Pinzas para torundas	412
US ARMY (PARKER-LANGENBECK)	
- Separadores	202

	página
V	
VANDERBILT	
- Pinzas hemostáticas	392
VANNAS	
- Tijeras microquirúrgicas vasculares	274-277
VARADY	
- Disecador, micro	247
- Flebodisecador	246
- Fleboextractor	246,247
- Fleboextractor, micro	247
- Sondas para varices	243
WISE	
- Micro Pinzas	297
VOLKMANN	
- Cucharillas cortantes	470
- Separadores	218-220,225
W	
WALTON-YANKAUER	
- Tubos de aspiración	312
WANGENSTEEN	
- Pinzas	367
- Porta-agujas	441
WAUGH	
- Pinzas	365
WEBER	
- Pinzas clamps para aorta	70
WEBSTER	
- Porta-agujas	432
WEINBERG	
- Separadores costales	139
WEITLANER	
- Separadores autoestáticos	191,192
WEITLANER-BECKMANN	
- Separadores autoestáticos	196
WICKSTROEM	
- Pinzas hemostáticas	401
WILLAUER	
- Tijeras torácicas	346
WILLIAMS	
- Pinzas para coger intestinos y tejidos	429
WOLF	
- Tubos de aspiración	311
WYLIE	
- Pinzas vasculares atraumáticas	36
Y	
YANKAUER	
- Tubos de aspiración	312
YANKAUER-BABY	
- Tubos de aspiración	312
YASARGIL	
- Micro Clip vascular	27
- Micro Disecadores	252
- Pinza para aplicar los clips vasculares	27
- Pinzas para aplicar clips de aneurisma	17
- Sistema de clips de aneurisma	13-19
- Tijeras microquirúrgicas vasculares	276,277
Z	
ZANGER	
- Inyector para heparin	319
ZAUFAL-JANSEN	
- Pinzas-gubias	456
ZENKER	
- Pinzas hemostáticas	395
- Separadores	216

	pagina
A	
ABRAMS	
- Ago per biopsia pleurica	320
ACLAND	
- Approssimatori	22
- Clips doppi	22
- Clips singoli	22
- Clips vascolari	22
- Pinze per applicare	23
ADSON	
- Cannule per aspirazione	316
- Divaricatori autostatici	197
- Periostotomi	472
- Pinze	352,353,366
- Pinze emostatiche	385
ADSON-BABY	
- Divaricatori autostatici	193
Aghi vascolari per irrigazione	316,319
Ago per biopsia pleurica	320
ALEXANDER	
- Periostotomi	476
ALLIS	
- Pinze per afferrare intestini e tessuti	423,424
ALLIS-BABY	
- Pinze per afferrare intestini e tessuti	423
ALLISON	
- Spatole per polmone	175
ALLPORT	
- Divaricatori autostatici	189
ALM	
- Divaricatori autostatici	189
ANDERSON-ADSON	
- Divaricatori autostatici	195
ANDREWS-PYNCHON	
- Tubi d'aspirazione	313
ANKENEY	
- Divaricatori sternali	165,166
Approssimatori	22,24,25
Approssimatori costali	171,172
Atraumatiche	
- Clamps vascolari	12,33-113
- Pinze	122-134
- Pinze Bulldog	3-8
- Pinze per afferrare organi	80
- Pinze per diversi usi	62-66, 103-105
B	
BABCOCK	
- Pinze per afferrare intestini e tessuti	425,426
BABY-ADSON	
- Pinze emostatiche	386
BABY-CRILE-WOOD	
- Portaghi	433
BABY-MOSQUITO	
- Pinze emostatiche	370
BABY-OVERHOLT	
- Pinze per dissezione e per legature	387
BABY-POOLE	
- Tubi d'aspirazione	309
BACKHAUS	
- Pinze fissateli	408
BADGLEY	
- Divaricatori per laminectomia	149
BAILEY	
- Approssimatori costali	172
- Pinze taglienti per aorta	182
BAILEY-BABY	
- Approssimatori costali	172
BAILEY-GIBBON	
- Approssimatori costali	172
BAINBRIDGE	
- Pinze atraumatiche per diversi usi	62
BALFOUR	
- Divaricatori addominali	199
BARRAQUER	
- Micro-Portaghi	280,282

	pagina
BAUMGARTNER	
- Pinze per ritorcere fili	490
- Portaghi	432
BEAL	
- Circumflex forbici	335
BECK	
- Pinze atraumatiche per diversi usi	66
BECKMANN	
- Divaricatori autostatici	196
BECKMANN-ADSON	
- Divaricatori autostatici	194
BECKMANN-EATON	
- Divaricatori autostatici	194
BENGOLEA	
- Pinze emostatiche	384
BERLIN	
- Pinze serretubi	404
BERRY	
- Pinze per ritorcere fili	491
BETHUNE	
- Costotomi	452
BEYER	
- Pinze sgorbie	456
BIEMER	
- Approssimatori	24
- Approssimatori per nervi	24
- Clips vascolari	24
- Divaricatore per vasi	251
- Forbici per vene	276,277
- Pinze per applicare	26
BIEMER-MÜLLER	
- Approssimatori	25
BLAKE	
- Pinza afferrare embolo	422
BOEHLER	
- Cesioie per ossa	463
- Pinze sgorbie	456
BOROWSKI	
- Divaricatori per aorta	179
BOZEMANN	
- Portaghi	441
BRAUN-RALPH	
- Tubi d'aspirazione	315
BRAUN-STADLER	
- Forbici per sterno	347
BRIDGE	
- Pinze emostatiche	396
BROMPTON	
- Pinze con rotoli	406
BROPHY	
- Pinze	359
BRUNNER	
- Costotomi	454
BRUNS	
- Curette taglienti	469
BÜCHS	
- Periostotomi	475
BUGGE	
- Divaricatori per mammaria	170
C	
CAIRNS	
- Divaricatori autostatici	193
- Unicini per nervi e vasi	248
CAIRNS-DOTT	
- Pinze	363
Cannule per apirazione	313,315-318
- per vene	319
CASPAR	
- Micro Dissettori	252
CASTAÑEDA	
- Divaricatori costali	136
- Pinze pediatriche per neonate e bambini	88-91
CASTROVIEJO	
- Micro-Portaghi	286-289
Cesioie per ossa	461-465

	pagina
CHITWOOD-DE BAKEY	
- Pinze atraumatiche	131
Clips	
- di TITANIO per legatura	21
- Sistema dei clips per aneurisma	13-16
- vascolari	22,24,27,28,30
- vascolari, TITANIO	2
COLLIN	
- Costotomi	450
CONE	
- Divaricatori autostatici	197
Contentitore	
- per il magazzino dei clips	
per aneurisma	18,19
per il magazzino dei clips vascolari	23
CONVERSE	
- Portaghi	431
COOLEY	
- Costotomi	452
- Dilatatori per valvole mitrali	255
- Dilatatori vascolari	257
- Divaricatori costali	136,138,139,140,145
- Divaricatori per atrio	176,177
- Pinze atraumatiche	126
- Pinze atraumatiche per diversi usi	103-105
- Pinze Bulldog	6
- Pinze Bulldog con manico di anello	92-94
- Pinze carotis	113
- Pinze pediatriche	
per neonate e bambini	96-102
- Pinze per anastomosi	109,111
- Pinze per cateteri	95
- Pinze per coartazione	106,107
- Pinze per iliaca	108
- Pinze per occlusione tangenziale	112
- Tubi d'aspirazione	310,314
COOLEY-BECK	
- Pinze per anastomosi	108
COOLEY-DERRA	
- Pinze per anastomosi	110
COPE	
- Ago per biopsia pleurica	320
CORYLLOS	
- Costotomi	451
- Divaricatori per torace	238
Costotomi	448-455
COTTLE	
- Unicini per nervi e vasi	248
CRAFOORD	
- Pinze emostatiche	393
- Toraciche forbici	347
CRAFOORD SELLORS	
- Pinze emostatiche	394
CRAWFORD	
- Divaricatori per aorta	180
CRILE	
- Pinze emostatiche	372,373
CRILE-WOOD	
- Portaghi	433
Curette taglienti	468-470
CUSHING	
- Divaricatore per vene	209
- Divaricatori	209,211
- Pinze	359,363
- Pinze taglienti per aorta	183
- Unicini per nervi e vasi	248
CUSHING-KOCHER	
- Divaricatori	212
D	
D'AMICO	
- Tubi d'aspirazione	311
DALE	
- Pinze vascolari per vasi perfici	57
DANDY	
- Pinze emostatiche	383

	pagina		pagina		pagina
DARDIK		Dilatatori per vasi	250,251,257-263	- micro	270-277
- Pinze vascolari atraumatiche	60,61	Dissettori	253	- per arte ria coronarica	340
DARLING		- vascolari	265	- per cartilagini	342
- Divaricatori autostatici	198	Distributore lame	303	- per chirurgia	322-324
DAVIDSON		- epicardiaco	187	- per dissezione	325-331
- Scapula divaricatori	239	- per vasi	251	- per legature	349
DAVIS		- per vene	209	- per lobo polmonare	348
- Elevatori, Periostotomi	254	Divaricatori	200-206,208-212,215-236,239	- per preparazione di nervi	342
DEAVER		- addominali	199	- per sterno	347,449
- Spatole addominali	213,214	- a forma di sella	208	- per vene	276,277
DE BAKEY		- autostatici	187-199	- toraciche	346-348
- Cannule per aspirazione	313	- costali	136-159	- SUPERCUT	322-324,327-329,337
- Cannule per vene	319	- per aorta	178-180	- vascolari	335-345
- Dilatatori vascolari	258,259,261	- per atrio	176,177	FRAZIER	
- Divaricatori costali	144,154,156	- per laminectomia	149	- Cannule per aspirazione	318
- Forbici compensare	340	- per mammaria	168,170	- Unicini per nervi e vasi	248
- Forbici vascolari	338	- per torace	237,238	FREER	
- Pinza per iliaca	81	- sternali	162-166	- Elevatori, Periostotomi	254
- Pinze aortiche	71	- toraciche	160	FREER-YASARGIL	
- Pinze atraumatiche	122-125,127,128,132-134	- vascolari	199	- Elevatori, Periostotomi	254
- Pinze atraumatiche per diversi usi	64,65	DIXON-LOVELACE		- Divaricatori	231
- Pinze Bulldog	4,8	- Pinze emostatiche	383	FRICTH	
- Pinze Bulldog con manico di anello	38,39	DOYEN		- Divaricatori	231
- Pinze per anastomosi	52	- Periostotomi costali	479-481	FRYKHOLM	
- Pinze per aneurisma di aorta	72,74,77	- Sonde	267	- Pinze sgorbie	460
- Pinze per coartazione	42-46	DUBOST		FUCHSIG	
- Pinze per dissezione e per legature	83	- Divaricatori costali	152	- Pinze per dissezione e per legature	387
- Pinze per legature	85	DURANTE		G	
- Pinze vascolari	12	- Pinze	369	GARRETT	
- Pinze vascolari atraumatiche	38,39,64,65	DUVAL		- Dilatatori vascolari	260
- Pinze vascolari per vasi perfici	54-56	- Pinze per afferrare intestini e tessuti	427	- Iniettore per eparina	319
- Portaghi	434,435	E		GEMINI	
- Tubi d'aspirazione	313	ECHLIN		- Pinze per dissezione e per legature	386
DE BAKEY-ADSON		- Pinze sgorbie	460	GEMINI mini	
- Pinze atraumatiche	129	EDWARDS		- Pinze per dissezione e per legature	387
DE BAKEY-BAHNSON		- Applicatore	117	GERALD	
- Pinze per aneurisma di aorta	73	- Clips	117	- Pinze	364
DE BAKEY-BECK		Elevatori	254	GIERTZ-STILLE	
- Pinze atraumatiche per diversi usi	66	ETHICON		- Costotomi	455
DE BAKEY-DIETHRICH		- Clips di TITANIO per legatura	21	GILLIES	
- Pinze atraumatiche	127	- Pinza per applicare	20	- Pinze	362
- Pinze Bulldog	3	F		- Portaghi	445
DE BAKEY-GERALD		FARABEUF		- Unicini per nervi e vasi	248
- Pinze atraumatiche	129	- Divaricatori	200	GIL VERNET	
DE BAKEY(LAMBERT modif.)		- Periostotomi	474	- Divaricatori a forma di sella	208
- Pinze aortiche	71	FARABEUF-COLLIN		GLASSMAN	
DE BAKEY-MC QUIGG-MIXTER		- Periostotomi	474	- Pinze atraumatiche	130
- Pinze per dissezione e per legature	82	FAVOLORO		GLOVER	
DE BAKEY-MIXTER		- Forbici per arteria coronarica	340	- Pinze Bulldog	7,8
- Pinze per dissezione e per legature	84	FERGUSON		- Pinze per anastomosi	50,51
DE BAKEY-MORRIS		- Tenaglie per ossa	466	GLOVER-DE BAKEY	
- Pinze per aneurisma di aorta	75	Filo per ossa	486	- Pinze vascolari atraumatiche	36
DE BAKEY-REYNOLDS		FINOCHIETTO		GLUCK	
- Pinze per anastomosi	53	- Divaricatori costali	137,140,149,150	- Costotomi	450
DE BAKEY-RUMEL		- Forbici per lobo polmonare	348	GREGORY	
- Pinze per dissezione e per legature	82	- Pinze per bronchi	417	- Pinze per profonda	87
DE BAKEY-SATINSKY		- Portaghi	442	GREGORY „SOFT“	
- Pinze per occlusione tangenziale	79	FINOCHIETTO-BABY		- Pinze Bulldog	5
DE BAKEY-SEMB		- Divaricatori costali	138	GROSS-MAIER	
- Pinze per aneurisma di aorta	76	FINOCHIETTO-BURFORD		- Pinze per medicatura	411
- Pinze per dissezione e per legature	83	- Divaricatori costali	144,151,158	GRUENWALD	
DE BAKEY-WHEELER		FINSEN		- Pinze	366
- Pinze atraumatiche	130	- Divaricatori autostatici	188	GUNNER-HEY	
DERF		FINSTERER		- Pinze con rotoli	406
- Portaghi	431	- Tubi d'aspirazione	315	H	
DERRA		FOERSTER		HABERER	
- Pinze per anastomosi	52	- Pinze per medicatura	413	- Spatole addominali	207
DESMARRES		FOGARTY		HAIGHT	
- Divaricatori	210	- Pinze vascolari con placche		- Divaricatori costali	141
DIEFFENBACH		- intercambiabili	114,115	HALSEY	
- Pinze Bulldog	11	- Placche di ricambio per pinze vascolari	116	- Portaghi	431
DIETHRICH		Forbici	322-349	HALSTED-MOSQUITO	
- Forbici vascolari	339	- compensare	340	- Pinze emostatiche	371
- Pinze Bulldog	3	- In-situ per valvole venose	343	- Pinze vascolari atraumatiche	34
- Pinze per aorta	69				
DIETHRICH-HEGEMANN					
- Forbici vascolari	338				
Dilatatori per valvole mitrali	255				

	pagina
HALSTED-MOSQUITO micro	
- Pinze emostatiche	371
HARKEN	
- Pinze ventricolari	40,41,422
HARRINGTON	
- Divaricatori	217
- Pinze per bronchi	417
HARRINGTON-BABY	
- Divaricatori	217
HARVEY	
- Forbici tagliafilari	492
- Tenaglie tagliafilari	494
HEANEY	
- Portaghi	440
HEGAR	
- Dilatatori vascolari	262,263
- Portaghi vascolari	437
HEISS	
- Pinze emostatiche	385
HENLEY	
- Divaricatori autostatici	190
HERTZLER	
- I.M.A. Divaricatori	167
HIBBS	
- Divaricatori	237
HOHENFELLNER	
- Forbici vascolari	344
HOPT	
- Pinze vascolari atraumatiche	35
I	
I.M.A.	
- Divaricatore epicardiaco	187
- Divaricatori	67-170
- Divaricatori per mammaria	168
- Iniettore per eparina	319
In-situ forbici valvole venose	343
IRIS	
- Forbici	333,334
ISRAEL	
- Divaricatori	226
J	
JACOBSON	
- Forbici micro-chirurgici vascolari	276,277
- Micro-Portaghi	286-289
- Sonde bottonute	251
JANSEN	
- Divaricatori autostatici	189
- Periostotomi	473
- Pinze	366
JAVID	
- Pinze carotis	86
JEFFERSON	
- Divaricatori autostatici	193
- Pinze	352,353
JOHNS-HOPKINS	
- Pinze Bulldog	10
JONES	
- Pinze fissateli	407
JONES-CLIP	
- Pinze fissateli	407
JORGENSEN	
- Toraciche forbici	348
JOSEPH	
- Forbici	332
JUDD-ALLIS	
- Pinze per afferrare intestini e tessuti	423
K	
KADER	
- Divaricatori	206

	pagina
KANTROWITZ	
- Pinze emostatiche	96
KARP	
- Pinze taglienti per aorta	181
KELLY	
- Divaricatori	205,235
- Pinze emostatiche	372,397
KILLIAN	
- Elevatori, Periostotomi	254
KILNER	
- Forbici	332
KLINKENBERG-LOTH	
- Toraciche forbici	348
KOCHER	
- Divaricatori	212,221-223,230,232
- Pinze emostatiche	379
KOCHER-LANGENBECK	
- Divaricatori	229
KOCHER-NIPPON	
- Pinze emostatiche	381
KOCHER-WAGNER	
- Divaricatori	233
KOENIG	
- Divaricatori	212
KOERTE	
- Divaricatori	215
KRÄMER	
- Periostotomi	475
KRAYENBÜHL	
- Unicini per nervi e vasi	249
L	
LAHEY	
- Pinze per peritoneo	402
LAMBERT-KAY	
- Pinze aortiche	71
LAMBOTTE	
- Periostotomi	473
LANDOLT	
- Manici per bisturi	307
LANE	
- Pinze fissateli	410
LANGENBECK	
- Divaricatori	227,228
- Periostotomi	475
- Tenaglie per ossa	466
LANGENBECK-GREEN	
- Divaricatori	210
LAWRENCE	
- Pinze emostatiche	395
LAZAR	
- Micro Pinze	296
LEBSCHÉ	
- Costotomi	453
- Scalpello per sterno	471
LEES	
- Pinze per bronchi	37
LEKSELL	
- Pinze sgorbie	459
LEKSELL-STILLE	
- Pinze sgorbie	459
LELAND-JONES	
- Pinze atraumatiche per diversi usi	63
LEMMON	
- Approssimatori costali	171
LERICHE	
- Divaricatori	215
- Pinze emostatiche	384
LEXER	
- Forbici per dissezione	327
LEXER-FINO	
- Forbici per dissezione	326
LICHTENBERG	
- Portaghi	444
LIDDLE	
- Pinze per aorta	67

	pagina
LISTER	
- Pinze sinus	415
LISTON	
- Cesioie per ossa	462
LITTAUER	
- Forbici per legature	349
LITTLEWOOD	
- Pinze per afferrare intestini e tessuti	428
LOCKHART-MUMMERY	
- Sonde	268
LORNA	
- Pinze fissateli	410
LOVE-GRUENWALD	
- Pinze taglienti per aorta	183
LOVELACE	
- Pinze per afferrare il polmone	416
LUCAE	
- Pinze	366
M	
Mandrino	256
Manici per bisturi	302-308
- micro	307-308
MARQUARDT	
- Pinze sgorbie	457
Martelli	471
MARTIN	
- Divaricatori	236
- Pinze per medicatura	414
- Spatole addominali	207
MARTIN-WYLIE	
- Pinze vascolari per vasi periferici	58,59
MATHIEU	
- Portaghi	443,444
MATSON	
- Periostotomi	477
MATSON ALEXANDER	
- Periostotomi	476
MAYO	
- Forbici per dissezione	325
MAYO-HEGAR	
- Portaghi	435
MAYO-STILLE	
- Forbici per dissezione	326
MC INDOE	
- Cesioie per ossa	463
- Forbici per cartilagini	342
- Pinze	362
MC KISSOCK	
- Periostotomi	475
MC QUIGG-MIXTER	
- Pinze emostatiche	401
MEEKER	
- Pinze emostatiche	396
MEHDORN	
- Clips vascolari	24
- Pinze per applicare	26
MERCEDES	
- Divaricatori toraciche	160
METZENBAUM	
- Forbici per dissezione	328
METZENBAUM-FINO	
- Forbici per dissezione	329,330,331
METZENBAUM-NELSON	
- Forbici per dissezione	331
Micro	
- Clips vascolari	27
- Dissettore	247,252
- Fleboestrattore	247
- Forbici per dissezione	274-277
- Forbici per vene	276,277
- Forbici vascolari	270-277
- Pinze	290-299
- Pinze con anelli	290,291,295
- Portaghi	278-289

	pagina		pagina		pagina
MICRO-ADSON		PEAN-NIPPON		POTTS-SMITH	
- Pinze	351	- Pinze emostatiche	380	- Forbici vascolari	335,337,339
- Pinze emostatiche	399	PEERS BERTRAM		- Pinze	361
MICRO-ADSON BIEMER		- Pinze fissateli	408	POTTS-YASARGIL	
- Pinze	351	PENNYBACKER		- Forbici micro-chirurgici vascolari	276,277
Micro-vascolari, Portaghi	437	- Dissettori	253	PRESBYTERIAN HOSPITAL	
MIDDELDORPF		Periostotomi	254,471-485	- Pinze serretubi	404
- Divaricatori	202	- costali	479-481	PRICE-THOMAS	
MIKULICZ		PERWITZCHKY		- Pinze per bronchi	418
- Divaricatori	234	- Forbici	334	PROVIDENCE-HOSPITAL	
- Pinze per peritoneo	403	Pinza per afferrare embolo	422	- Pinze emostatiche	373
MIKULICZ-BABY		Pinza per applicare e rimuovere pinze Bulldog	10		
- Pinze per peritoneo	402	Pinze	350-369	R	
MILLESI		- atraumatiche	122-134		
- Forbici micro-chirurgici vascolari	276,277	- Micro	290-299	RAGNELL	
MILLS		- TITANIO	123,125,133,350,352,362,364	- Divaricatori	203
- Forbici vascolari	337	Pinze aortiche	71	RAMEL	
MISKIMOM		Pinze Bulldog	3-11	- Ago per biopsia pleurica	320
- Divaricatori autostatici	195	Pinze Bulldog con manico di anello	38,39,92-94	RAMPLEY	
MIXTER		Pinze carotis	86,113	- Pinze per medicatura	414
- Pinze emostatiche	398,400	Pinze con rotoli	406	RANKIN	
MIXTER-BABY		Pinze emostatiche	370-385,392-401	- Pinze emostatiche	372
- Pinze emostatiche	399	- TITANIO	372	- Pinze vascolari atraumatiche	34
MIXTER-O'SHAUGNESSY		Pinze fissateli	407-410	Recipienti metallici	261
- Pinze emostatiche	400	Pinze pediatriche per neonate e bambini		REILL	
MOCK (DE BAKEY)		-	88-91,96-101	- Micro-Portaghi	280-283
- Iniettore per eparina	319	Pinze per afferrare il cuore-valvola	429	- Tenaglie tagliafilii	493
Modello russo, pinze	368	Pinze per afferrare il polmone	416	REYNOLDS	
MORSE		Pinze per afferrare intestini e tessuti	423-429	- Forbici	333
- Divaricatori sternali	162,164	Pinze per afferrare organi	80	RICHARDSON	
MORSE-FAVOLORO		Pinze per anastomosi	50-53,108-111,420,421	- Divaricatori	202,204
- Divaricatori sternali	163	Pinze per aneurisma di aorta	72-77	ROBB	
MÜLLER		Pinze per aorta	67-70,108-111	- Dissettori vascolari	265
- Approssimatori	25	Pinze per applicare		ROBERTS	
- Clips vascolari	27	- ACLAND Clips vascolari	23	- Pinze emostatiche	394
- Pinza per legature	27	- Approssimatori	26	ROCHESTER-CARMALT	
- Unicini per nervi e vasi	248	- Clips per aneurisma	17	- Pinze emostatiche	383
MURPHY		- Clips per legatura	20	ROCHESTER-OCHSNER	
- Divaricatori	224	- Clips vascolari	26,29,30	- Pinze emostatiche	376,377
- Pinze serretubi	405	- EDWARDS Clips	117	ROCHESTER-PEAN	
		- Micro Clip vascolari	27	- Pinze emostatiche	374,375
N		Pinze per bronchi	37,417-419	ROSS	
		Pinze per cateteri	95	- Divaricatori per aorta	178
NABATOFF		Pinze per coartazione	42-49,106,107	ROUX	
- Sonde per vein	242	Pinze per dissezione e per legature		- Divaricatori	200,201
NEIVERT		-	82-84,386-391,415,419	RUMEL	
- Portaghi	432	Pinze per diversi usi	62-66,103-105	- Pinze emostatiche	392
NELSON		Pinze per iliaca	81,108	RUMEL-BELMONT	
- Pinze	367	Pinze per legature	27,85,370	- Tornichetti	256
- Trequarti	321	Pinze per medicatura	411-414	RUSKIN	
		Pinze per occlusione tangenziale	78,79,112	- Pinze sgorbie	457
O		Pinze per peritoneo	402	RUSKIN-LISTON	
		Pinze per profonda	87	- Cesoie per ossa	464
OCHSNER		Pinze per ritorcere fili	489-491	RYDER	
- Divaricatori vascolari	199	Pinze serretubi	404,405	- Portaghi	436
- Pinze per aorta	69	Pinze sgorbie	456-461	- Portaghi vascolari	438,439
- Trequarti	321	Pinze sinus	415		
OLSEN-HEGAR		Pinze taglienti per aorta	181-183	S	
- Portaghi	445	Pinze vascolari	12		
OPPEL		Pinze vascolari		SANTULLI	
- Micro Dissettori	252	con placche intercambiabili	114,115	- Pinze Bulldog	5
OVERHOLT		Pinze vascolari, flessibili	118-119	SANVERNO	
- Periostotomi	477,478	Pinze vascolari per vasi perfici	54-59	- Forbici	332
- Pinze per dissezione e per legature	390,391	Pinze ventricolari	40,41,422	SAROT	
OVERHOLT fino		Placche di ricambio per pinze vascolari	116	- Pinze emostatiche	393
- Pinze per dissezione e per legature	390	PLESTER		- Pinze per bronchi	419
OVERHOLT-GEISSENDOERFER		- Cannule per aspirazione	317	- Portaghi	442
- Pinze per dissezione e per legature	388,389	POOLE		SATINSKY	
OVERHOLT-MIXTER		- Tubi d'aspirazione	309	- Forbici vascolari	345
- Pinze per dissezione e per legature	391	POPPEL		- Pinze per anastomosi	420,421
		- Cannule per aspirazione	317	- Pinze per occlusione tangenziale	78
P		Portaghi	431-445	SAUERBRUCH	
		Portaghi, micro	278-289	- Costotomi	453
PARKER-LANGENBECK		Porta-legature	256	- Divaricatori	239
- Divaricatori	202	POTTS		- Pinze sgorbie	459
PEAN		- Pinze per coartazione	47-49	SAUERBRUCH-FREY	
- Pinze emostatiche	378	POTTS-DE MARTEL		- Costotomi	454
- Pinze vascolari atraumatiche	33	- Forbici vascolari	337,339	Scalpello per sterno	471

	pagina
Scapula divaricatori	239
SCHAEDEL	
- Pinze fissateli	407
SCHEDÉ	
- Curette taglienti	468
SCHIEBE	
- Pinze per afferare intestini e tessuti	428
SCHMID	
- Aghi vascolari per irrigazione	316
- Spatole per intima	266
SCHNIDT	
- Pinze per dissezione e per legature	415
SCHOENBORN	
- Divaricatori	209
SCHUMACHER	
- Forbici per sterno	449
SCHWARTZ	
- Clips vascolari	30
- Pinza per applicare	30
SELLORS	
- Approssimatori costali	171
SELMAN	
- Pinze	368
SEMB	
- Cesioie per ossa	465
- Periostotomi	482,483
- Pinze per dissezione e per legature	419
- Pinze sgorbie	460
- Spatole per polmone	175
- Tenaglie per ossa	467
SEMKEN	
- Pinze	350
SENN-MILLER	
- Divaricatori	203
SHUNT	
- Pinze Bulldog	9
SIMON	
- Divaricatori	236
SINGLEY-TUTTLE	
- Pinze	369
Sistema dei clips per aneurisma	13-19
- Clip contenitore	18-19
- MINI Clips	15,16
- PHYNOX Clips	13-16
- Pinze per applicare clips	17
- STANDARD Clips	13,14
- TITANIO Clips	13-16
SMITH-PETERSEN	
- Pinze sgorbie	461
Sonde	267,268
- bottonute	251
- per vein	242-245
Spatole addominali	207,213,214
- per intima	266
- per polmone	175,239
SPENCER	
- Forbici per legature	349
SPENCER-WELLS	
- Pinze emostatiche	382
SPURLING	
- Pinze taglienti per aorta	183
STANDARD	
- Forbici	322-324
- Pinza per applicare clips per legatura	20
- Pinze	354,356,358
STILLE	
- Costotomi	450
STILLE-HORSLEY	
- Cesioie per ossa	465
STILLE-LISTON	
- Cesioie per ossa	464,465
STILLE-LUER	
- Pinze sgorbie	458
STRATTE	
- Portaghi	440
STRUCK	
- Divaricatori costali	142

	pagina
STRULLY	
- Forbici vascolari	341
Strumenti per varici	246,247
SUBRAMANIAN	
- Pinze per aorta	68
SUBRAMANIAN MINIATURE	
- Pinze per aorta	68
SUPERCUT forbici	322-324,327-329,337
T	
TEALE	
- Pinze per afferrare il cuore-valvola	429
Tenaglie per ossa	466-467
- piatte	486-489
- tagliafilì	492-495
- tagliafilì laterali	492-495
TESSIER	
- Divaricatori per torace	237
THOMS-ALLIS	
- Pinze per afferrare intestini e tessuti	424
THOREK	
- Toraciche forbici	346
TITANIO	
- Clips per aneurisma	13-16
- Clips per legature	21
- Clips vascolari	2
- Pinze	123,125,133,350,352,362,364
- Pinze aortiche	71,72
- Pinze atraumatiche per diversi usi	63,65,66
- Pinze carotis	113
- Pinze emostatiche	372
- Pinze per anastomosi	50-52,108
- Pinze per aneurisma di aorta	76
- Pinze per aorta	68
- Pinze per bronchi	37
- Pinze per coartazione	47,106,107
- Pinze per iliaca	108
- Pinze per occlusione tangenziale	78
- Pinze vascolari per vasi periferici	56
TOENNIS	
- Dissettori	253
- Portaghi	443
- Unicini per nervi e vasi	248
TOENNIS-ADSON	
- Forbici vascolari	341
TOHOKU	
- Pinze fissateli	409
Toraciche forbici	346-348
Tornichetti	256
Trequarti	321
TUBBS	
- Dilatatori per valvole mitrali	255
Tubi d'aspirazione	309-317
TUFFIER	
- Divaricatori costali	148
Tunnellizzazione, Set per	264
U	
ULRICH	
- Pinze per medicatura	412
Unicini per nervi e vasi	248,249
US ARMY (PARKER-LANGENBECK)	
- Divaricatori	202
V	
VANDERBILT	
- Pinze emostatiche	392
VANNAS	
- Forbici micro-chirurgici vascolari	274-277
VARADY	
- Dissettoie, micro	247
- Flebodissettoie	246
- Fleboestrattore	246,247
- Fleboestrattore, micro	247
- Sonde per vein	243

	pagina
WISE	
- Micro Pinze	297
VOLKMANN	
- Curette taglienti	470
- Divaricatori	218-220,225
W	
WALTON-YANKAUER	
- Tubi d'aspirazione	312
WANGENSTEEN	
- Pinze	367
- Portaghi	441
WAUGH	
- Pinze	365
WEBER	
- Pinze per aorta	70
WEBSTER	
- Portaghi	432
WEINBERG	
- Divaricatori costali	139
WEITLANER	
- Divaricatori autostatici	191,192
WEITLANER-BECKMANN	
- Divaricatori autostatici	196
WICKSTROEM	
- Pinze emostatiche	401
WILLAUER	
- Toraciche forbici	346
WILLIAMS	
- Pinze per afferrare intestini e tessuti	429
WOLF	
- Tubi d'aspirazione	311
WYLIE	
- Pinze vascolari atraumatiche	36
Y	
YANKAUER	
- Tubi d'aspirazione	312
YANKAUER-BABY	
- Tubi d'aspirazione	312
YASARGIL	
- Forbici micro-chirurgici vascolari	276,277
- Micro Clip vascolari	27
- Micro Dissettori	252
- Pinze per applicare i clips per aneurisma	17
- Pinza per applicare i clips vascolari	27
- Sistema dei clips per aneurisma	13-19
Z	
ZANGER	
- Iniettore per eparina	319
ZAUFAL-JANSEN	
- Pinze sgorbie	456
ZENKER	
- Divaricatori	216
- Pinze emostatiche	395

Seite	Seite	Seite			
01-01-632	448	02-03-321	323	02-03-669	340
01-14-908	404	02-03-323	323	02-03-670	340
01-14-909	404	02-03-324	323	02-03-672	342
01-14-911	405	02-03-325	323	02-03-801	349
01-14-912	405	02-03-326	323	02-03-802	349
01-14-913	405	02-03-327	323	02-03-803	349
01-51-631	448	02-03-328	323	02-03-815	492
01-64-910	404	02-03-330	323	02-04-023	355
01-64-911	405	02-03-341	324	02-04-025	355
01-64-912	405	02-03-343	324	02-04-027	355
01-64-913	405	02-03-344	324	02-04-029	355
02-02-046	308	02-03-345	324	02-04-030	355
02-02-048	308	02-03-346	324	02-04-031	355
02-02-052	308	02-03-411	322	02-04-032	355
02-02-053	307	02-03-413	322	02-04-033	355
02-02-054	308	02-03-414	322	02-04-043	354
02-02-057	307	02-03-415	322	02-04-045	354
02-02-063	303	02-03-416	322	02-04-047	354
02-02-071	307	02-03-417	322	02-04-049	354
02-02-073	302	02-03-421	323	02-04-050	354
02-02-075	302	02-03-423	323	02-04-051	354
02-02-077	305	02-03-424	323	02-04-052	354
02-02-078	304	02-03-425	323	02-04-053	354
02-02-079	304	02-03-426	323	02-04-151	352
02-02-084	306	02-03-427	323	02-04-154	358
02-02-085	306	02-03-428	323	02-04-156	358
02-03-030	334	02-03-441	324	02-04-157	358
02-03-033	334	02-03-443	324	02-04-158	358
02-03-064	333	02-03-444	324	02-04-159	358
02-03-065	333	02-03-445	324	02-04-160	363
02-03-100	333	02-03-544	325	02-04-164	358
02-03-101	333	02-03-545	325	02-04-165	358
02-03-106	333	02-03-547	325	02-04-166	358
02-03-107	333	02-03-554	325	02-04-168	366
02-03-110	333	02-03-555	325	02-04-171	367
02-03-111	333	02-03-557	325	02-04-173	367
02-03-117	334	02-03-570	326	02-04-210	350
02-03-156	332	02-03-572	326	02-04-213	362
02-03-157	332	02-03-573	326	02-04-215	350
02-03-166	332	02-03-575	326	02-04-215T	350
02-03-168	332	02-03-590	327	02-04-220	351
02-03-180	333	02-03-591	327	02-04-222	352
02-03-181	333	02-03-601	328	02-04-222T	352
02-03-210	333	02-03-602	328	02-04-223	351
02-03-211	333	02-03-604	328	02-04-224	352
02-03-224	323	02-03-605	328	02-04-226	352
02-03-228	324	02-03-606	328	02-04-228	364
02-03-231	322	02-03-607	328	02-04-228T	364
02-03-234	323	02-03-611	328	02-04-229	364
02-03-245	338	02-03-612	328	02-04-230	364
02-03-250	325	02-03-613	328	02-04-231	359
02-03-251	325	02-03-614	328	02-04-232	359
02-03-252	325	02-03-615	328	02-04-236	362
02-03-253	325	02-03-616	328	02-04-236T	362
02-03-256	328	02-03-618	328	02-04-238	359
02-03-257	328	02-03-619	328	02-04-239	359
02-03-260	328	02-03-628	342	02-04-240	359
02-03-261	328	02-03-636	346	02-04-243	359
02-03-262	328	02-03-640	348	02-04-246	359
02-03-263	328	02-03-641	345	02-04-247	359
02-03-265	328	02-03-642	336	02-04-257	359
02-03-273	341	02-03-644	341	02-04-260	296
02-03-274	328	02-03-645	341	02-04-261	296
02-03-276	328	02-03-646	337	02-04-264	296
02-03-277	328	02-03-647	337	02-04-268	363
02-03-279	328	02-03-648	337	02-04-269	363
02-03-281	328	02-03-649	337	02-04-329	299
02-03-283	327	02-03-650	339	02-04-330	299
02-03-289	328	02-03-651	337	02-04-331	299
02-03-313	322	02-03-652	339	02-04-333	299
02-03-314	322	02-03-653	338	02-04-335	298
02-03-315	322	02-03-654	338	02-04-336	297
02-03-316	322	02-03-662	338	02-04-337	297
02-03-317	322	02-03-663	338	02-04-338	297
02-03-320	323	02-03-664	338	02-04-343	299

Seite	Seite	Seite			
02-04-345	297	02-06-118	414	02-08-171	170
02-04-506	353	02-06-120	413	02-08-176	373
02-04-507	353	02-06-121	413	02-08-177	373
02-04-508	353	02-06-122	413	02-08-178	383
02-04-509	351	02-06-123	413	02-08-198	387
02-04-510	351	02-06-401	407	02-08-200	385
02-04-511	353	02-06-407	407	02-08-201	385
02-04-512	353	02-06-411	407	02-08-202	371
02-04-513	353	02-06-431	408	02-08-203	371
02-04-520	351	02-06-432	408	02-08-206	385
02-04-521	353	02-06-433	408	02-08-207	385
02-04-522	353	02-06-450	410	02-08-209	385
02-04-523	353	02-06-451	410	02-08-210	371
02-04-527	357	02-06-452	410	02-08-211	371
02-04-533	357	02-06-460	408	02-08-212	371
02-04-535	357	02-06-461	410	02-08-213	371
02-04-537	357	02-06-463	410	02-08-214	371
02-04-539	357	02-06-464	409	02-08-215	371
02-04-540	357	02-06-465	409	02-08-224	393
02-04-541	357	02-06-466	409	02-08-225	393
02-04-542	357	02-08-012	10	02-08-228	384
02-04-543	357	02-08-013	10	02-08-229	384
02-04-553	356	02-08-014	10	02-08-230	396
02-04-555	356	02-08-015	10	02-08-231	396
02-04-557	356	02-08-016	10	02-08-238	384
02-04-559	356	02-08-017	10	02-08-239	384
02-04-560	356	02-08-018	10	02-08-332	382
02-04-561	356	02-08-020	11	02-08-333	382
02-04-562	356	02-08-021	11	02-08-334	382
02-04-563	356	02-08-022	11	02-08-335	382
02-04-575	360	02-08-023	11	02-08-336	382
02-04-577	360	02-08-026	11	02-08-337	382
02-04-579	360	02-08-027	11	02-08-338	382
02-04-580	360	02-08-104	370	02-08-339	382
02-04-581	360	02-08-105	370	02-08-412	378
02-04-660	362	02-08-108	371	02-08-413	378
02-04-661	362	02-08-109	371	02-08-414	378
02-04-662	364	02-08-110	371	02-08-415	378
02-04-663	364	02-08-110T	371	02-08-424	374
02-04-664	364	02-08-111	371	02-08-425	375
02-04-665	350	02-08-111T	371	02-08-442	374
02-04-666	350	02-08-114	370	02-08-443	375
02-04-667	350	02-08-115	370	02-08-444	374
02-04-668	350	02-08-118	371	02-08-445	375
02-04-669	350	02-08-119	371	02-08-446	374
02-04-670	365	02-08-120	371	02-08-447	375
02-04-671	365	02-08-120T	371	02-08-448	374
02-04-672	365	02-08-121	371	02-08-449	375
02-04-679	365	02-08-121T	371	02-08-450	374
02-04-755	368	02-08-130	373	02-08-451	375
02-04-760	368	02-08-131	373	02-08-472	374
02-04-801	369	02-08-134	372	02-08-473	375
02-04-802	367	02-08-134T	372	02-08-474	374
02-04-870	366	02-08-135	372	02-08-475	375
02-04-878	366	02-08-135T	372	02-08-612	379
02-04-879	366	02-08-139	383	02-08-614	379
02-04-880	366	02-08-140	371	02-08-615	379
02-04-883	366	02-08-141	371	02-08-618	376
02-04-885	366	02-08-143	383	02-08-619	377
02-04-886	366	02-08-144	372	02-08-642	376
02-06-004	415	02-08-144T	372	02-08-643	377
02-06-006	415	02-08-145	372	02-08-644	376
02-06-008	415	02-08-145T	372	02-08-645	377
02-06-021	414	02-08-150	371	02-08-646	376
02-06-046	411	02-08-151	371	02-08-647	377
02-06-047	411	02-08-154	372	02-08-648	376
02-06-058	411	02-08-155	372	02-08-649	377
02-06-059	411	02-08-160	384	02-08-650	376
02-06-060	412	02-08-161	384	02-08-651	377
02-06-061	412	02-08-164	372	02-08-652	376
02-06-062	412	02-08-165	372	02-08-653	377
02-06-063	412	02-08-166	373	02-08-654	376
02-06-112	413	02-08-167	373	02-08-655	377
02-06-113	413	02-08-168	383	02-08-800	383
02-06-116	414	02-08-170	170	02-08-801	383

	Seite		Seite		Seite
02-08-804	383	02-13-020	442	02-20-032	201
02-08-805	383	02-13-021	433	02-20-033	201
02-08-812	394	02-13-023	442	02-20-041	202
02-08-813	394	02-13-025	434	02-20-082	248
02-08-957	415	02-13-027	434	02-20-083	248
02-08-959	415	02-13-032	435	02-20-084	248
02-10-008	399	02-13-035	435	02-20-177	210
02-10-009	387	02-13-036	435	02-20-178	210
02-10-011	399	02-13-037	435	02-20-182	212
02-10-012	399	02-13-038	435	02-20-183	212
02-10-013	386	02-13-040	434	02-20-184	211
02-10-014	386	02-13-042	441	02-20-185	211
02-10-015	391	02-13-044	436	02-20-190	212
02-10-016	391	02-13-045	436	02-20-192	209
02-10-017	391	02-13-046	436	02-20-200	209
02-10-018	391	02-13-047	436	02-20-201	209
02-10-019	391	02-13-054	438	02-20-202	209
02-10-020	388	02-13-055	438	02-20-232	225
02-10-021	388	02-13-056	438	02-20-238	221
02-10-022	388	02-13-057	438	02-20-239	222
02-10-023	388	02-13-065	435	02-20-240	225
02-10-024	388	02-13-066	435	02-20-241	225
02-10-025	388	02-13-067	435	02-20-242	218
02-10-026	388	02-13-069	435	02-20-243	218
02-10-031	389	02-13-074	436	02-20-244	218
02-10-032	389	02-13-075	436	02-20-246	218
02-10-033	389	02-13-076	436	02-20-248	218
02-10-034	389	02-13-081	440	02-20-252	220
02-10-035	389	02-13-084	440	02-20-253	220
02-10-041	392	02-13-092	442	02-20-254	220
02-10-042	392	02-13-095	440	02-20-256	220
02-10-044	392	02-13-096	440	02-20-257	219
02-10-045	392	02-13-100	441	02-20-258	220
02-10-047	395	02-13-101	441	02-20-259	219
02-10-048	395	02-13-102	441	02-20-260	219
02-10-050	400	02-13-110	491	02-20-261	219
02-10-051	401	02-13-111	491	02-20-262	221
02-10-055	398	02-13-112	490	02-20-263	221
02-10-057	396	02-13-113	491	02-20-264	221
02-10-058	396	02-13-127	445	02-20-265	219
02-10-059	396	02-13-129	445	02-20-266	221
02-10-060	402	02-13-132	444	02-20-272	222
02-10-061	400	02-13-148	444	02-20-273	222
02-10-062	400	02-13-149	443	02-20-274	222
02-10-070	395	02-13-150	444	02-20-276	222
02-10-080	390	02-13-151	443	02-20-284	226
02-10-081	390	02-13-153	444	02-20-285	226
02-10-082	390	02-13-154	443	02-20-286	226
02-10-083	390	02-13-186	443	02-20-287	226
02-10-086	390	02-13-200	431	02-20-320	227
02-10-090	390	02-13-201	431	02-20-321	227
02-10-091	390	02-13-202	432	02-20-323	227
02-10-096	390	02-13-204	431	02-20-325	227
02-10-100	386	02-13-205	431	02-20-326	227
02-10-102	386	02-13-218	433	02-20-327	228
02-10-103	386	02-13-299	445	02-20-328	228
02-10-104	386	02-13-563	287	02-20-332	228
02-10-106	386	02-13-564	287	02-20-354	229
02-10-300	402	02-14-003	267	02-20-356	229
02-10-313	403	02-14-004	267	02-20-357	229
02-10-314	403	02-14-006	267	02-20-358	229
02-13-001	289	02-14-010	267	02-20-359	229
02-13-002	289	02-14-015	267	02-20-361	229
02-13-004	289	02-14-021	268	02-20-363	229
02-13-005	289	02-14-022	268	02-20-364	229
02-13-008	431	02-14-023	268	02-20-365	229
02-13-010	431	02-14-024	268	02-20-369	230
02-13-011	431	02-20-004	203	02-20-370	230
02-13-012	431	02-20-008	203	02-20-371	230
02-13-013	433	02-20-020	200	02-20-372	230
02-13-014	432	02-20-021	200	02-20-373	230
02-13-015	432	02-20-028	201	02-20-457	212
02-13-016	433	02-20-029	201	02-20-458	212
02-13-017	433	02-20-030	201	02-20-460	232
02-13-019	433	02-20-031	201	02-20-461	232

Seite	Seite	Seite
02-20-462232	02-22-010189	02-53-054322
02-20-463232	02-22-011189	02-53-055322
02-20-470202	02-22-028189	02-53-056322
02-20-471202	02-22-030189	02-53-057322
02-20-472202	02-22-032189	02-53-058322
02-20-475204	02-22-066192	02-53-059322
02-20-476204	02-22-067192	02-53-060323
02-20-477204	02-22-068191	02-53-061323
02-20-478204	02-22-070192	02-53-062323
02-20-481205	02-22-071192	02-53-063323
02-20-482205	02-22-072191	02-53-064323
02-20-483205	02-22-073192	02-53-065323
02-20-484205	02-22-074192	02-53-066323
02-20-490233	02-22-075191	02-53-067323
02-20-492233	02-22-083193	02-53-068323
02-20-494233	02-22-085193	02-53-069323
02-20-498233	02-22-092193	02-53-070323
02-20-514239	02-22-101191	02-53-071323
02-20-521238	02-22-104191	02-53-072323
02-20-522238	02-22-200191	02-53-073323
02-20-523238	02-22-201191	02-53-074323
02-20-531239	02-22-206191	02-53-075323
02-20-551217	02-22-207191	02-53-076323
02-20-552217	02-22-208191	02-53-077323
02-20-553217	02-22-209191	02-53-080324
02-20-555239	02-22-250195	02-53-081324
02-20-559175	02-22-260197	02-53-082324
02-20-560175	02-22-271194	02-53-083324
02-20-561175	02-22-272194	02-53-084324
02-20-594216	02-22-273197	02-53-085324
02-20-595216	02-22-276194	02-53-086324
02-20-596216	02-22-512167	02-53-087324
02-20-597216	02-22-608199	02-53-088324
02-20-600213	02-52-060303	02-53-089324
02-20-601213	02-52-063303	02-53-090324
02-20-602213	02-52-071307	02-53-091324
02-20-603213	02-52-073302	02-53-092324
02-20-604214	02-52-075302	02-53-093324
02-20-605214	02-52-077305	02-53-094324
02-20-606213	02-52-078304	02-53-095324
02-20-607213	02-52-079305	02-53-096324
02-20-608214	02-52-084306	02-53-097324
02-20-611214	02-52-085306	02-53-098324
02-20-613214	02-52-2003	02-53-099324
02-20-614214	02-52-2013	02-53-126332
02-20-615214	02-52-2023	02-53-127332
02-20-618234	02-52-2033	02-53-130328
02-20-621234	02-52-2043	02-53-131328
02-20-622234	02-52-2053	02-53-132328
02-20-623234	02-52-2103	02-53-133328
02-20-624234	02-52-2113	02-53-134328
02-20-630235	02-52-2123	02-53-135328
02-20-633235	02-52-2133	02-53-136328
02-20-655231	02-52-2143	02-53-137328
02-20-656231	02-52-2153	02-53-138328
02-20-657231	02-53-032334	02-53-139328
02-20-658231	02-53-035335	02-53-140328
02-20-659231	02-53-036335	02-53-141328
02-20-730215	02-53-037335	02-53-142328
02-20-732215	02-53-038336	02-53-143328
02-20-742215	02-53-039336	02-53-144328
02-20-746206	02-53-040322	02-53-145328
02-20-747206	02-53-041322	02-53-146328
02-20-750207	02-53-042322	02-53-147328
02-20-758207	02-53-043322	02-53-148328
02-20-761207	02-53-044322	02-53-149328
02-20-762207	02-53-045322	02-53-150328
02-20-763207	02-53-046322	02-53-151328
02-20-773206	02-53-047322	02-53-152328
02-20-774206	02-53-048322	02-53-153328
02-20-775206	02-53-049322	02-53-154328
02-20-776206	02-53-050322	02-53-155328
02-20-777206	02-53-051322	02-53-156328
02-22-001188	02-53-052322	02-53-157328
02-22-002188	02-53-053322	02-53-158328

Seite	Seite	Seite			
02-53-178	333	02-53-629	329	02-53-710	346
02-53-179	333	02-53-630	329	02-53-711	346
02-53-180	333	02-53-631	329	02-53-712	346
02-53-199	324	02-53-632	329	02-53-713	347
02-53-200	324	02-53-633	329	02-53-714	348
02-53-201	324	02-53-634	329	02-53-715	348
02-53-202	324	02-53-635	329	02-53-716	348
02-53-203	324	02-53-636	329	02-53-800	349
02-53-204	324	02-53-637	329	02-54-152	352
02-53-205	324	02-53-638	329	02-54-153	352
02-53-206	323	02-53-639	329	02-54-154	352
02-53-207	323	02-53-655	338	02-54-155	358
02-53-208	323	02-53-656	338	02-54-161	363
02-53-209	323	02-53-657	338	02-54-162	363
02-53-210	323	02-53-658	337	02-54-174	367
02-53-211	323	02-53-659	337	02-54-223	352
02-53-230	322	02-53-660	337	02-54-237	362
02-53-232	322	02-53-661	338	02-54-248	359
02-53-233	322	02-53-662	338	02-54-269	363
02-53-234	322	02-53-663	338	02-54-331	298
02-53-235	322	02-53-664	338		
02-53-236	322	02-53-665	338		
02-53-237	322	02-53-666	338		
02-53-254	325	02-53-667	338		
02-53-255	325	02-53-668	338		
02-53-266	332	02-53-669	338		
02-53-268	332	02-53-670	342		
02-53-276	328	02-53-673	339		
02-53-278	326	02-53-674	339		
02-53-279	326	02-53-679	340		
02-53-280	326	02-53-680	337		
02-53-281	326	02-53-681	337		
02-53-282	327	02-53-682	337		
02-53-284	327	02-53-683	337		
02-53-285	327	02-53-684	337		
02-53-286	328	02-53-685	337		
02-53-288	328	02-53-690	338		
02-53-311	322	02-53-691	338		
02-53-312	322	02-53-692	338		
02-53-318	322	02-53-693	338		
02-53-319	322	02-53-694	338		
02-53-340	324	02-53-695	338		
02-53-347	324	02-53-696	338		
02-53-348	324	02-53-697	338		
02-53-349	324	02-53-698	338		
02-53-410	322	02-53-700	343		
02-53-418	322	02-53-701	343		
02-53-419	322	02-53-702	343		
02-53-420	323	02-53-703	343		
02-53-429	323	02-53-704	343		
02-53-430	328	02-53-705	344		
02-53-431	328	02-53-706	344		
02-53-432	328	02-53-707	344		
02-53-440	324	02-53-708	345		
02-53-446	324	02-53-709	345		
02-53-447	324	02-53-710	346		
02-53-448	324	02-53-711	346		
02-53-449	324	02-53-712	346		
02-53-462	329	02-53-713	347		
02-53-463	329	02-53-714	348		
02-53-464	329	02-53-715	348		
02-53-466	325	02-53-716	348		
02-53-467	325	02-53-800	349		
02-53-468	325	02-54-152	352		
02-53-469	325	02-54-153	352		
02-53-475	325	02-54-154	352		
02-53-476	325	02-54-155	358		
02-53-477	325	02-54-161	363		
02-53-478	325	02-54-162	363		
02-53-479	325	02-54-174	367		
02-53-480	325	02-54-223	352		
02-53-481	325	02-54-237	362		
02-53-490	329	02-54-248	359		
02-53-491	329	02-54-269	363		
02-53-492	329	02-54-331	298		
02-53-493	329				
02-53-494	329				
02-53-495	329				
02-53-496	329				
02-53-497	329				
02-53-498	329				
02-53-500	329				
02-53-501	329				
02-53-502	329				
02-53-503	329				
02-53-504	329				
02-53-505	329				
02-53-506	329				
02-53-507	329				
02-53-508	329				
02-53-509	329				
02-53-510	329				
02-53-511	329				
02-53-514	331				
02-53-515	331				
02-53-516	331				
02-53-517	331				
02-53-520	330				
02-53-521	330				
02-53-522	330				
02-53-523	330				
02-53-524	330				
02-53-525	330				
02-53-526	330				
02-53-527	330				
02-53-528	330				
02-53-529	330				
02-53-530	330				
02-53-531	330				
02-53-532	330				
02-53-533	330				
02-53-534	330				
02-53-535	330				
02-53-548	325				
02-53-549	325				
02-53-550	325				
02-53-558	325				
02-53-559	325				
02-53-560	325				
02-53-574	326				
02-53-576	326				
02-53-577	326				
02-53-579	326				
02-53-580	327				
02-53-581	327				
02-53-582	327				
02-53-583	327				
02-53-584	327				
02-53-585	327				
02-53-586	327				
02-53-587	327				
02-53-590	326				
02-53-591	326				
02-53-592	327				
02-53-593	327				
02-53-599	328				
02-53-601	328				
02-53-610	329				
02-53-611	329				
02-53-612	329				
02-53-613	329				
02-53-620	329				
02-53-621	329				
02-53-622	329				
02-53-623	329				
02-53-624	329				
02-53-625	329				
02-53-626	329				
02-53-627	329				
02-53-628	329				

Seite	Seite	Seite			
02-54-332	298	02-58-111	397	02-63-044	436
02-54-333	298	02-58-112	397	02-63-046	436
02-54-513	353	02-58-116	371	02-63-047	436
02-54-521	351	02-58-117	371	02-63-050	439
02-54-522	351	02-58-120	397	02-63-051	439
02-54-523	351	02-58-121	397	02-63-052	439
02-54-561	356	02-58-122	397	02-63-053	439
02-54-574	360	02-58-202	385	02-63-054	439
02-54-582	360	02-58-203	385	02-63-058	438
02-54-600	361	02-58-224	393	02-63-059	438
02-54-601	361	02-58-225	393	02-63-064	435
02-54-602	361	02-58-226	384	02-63-067	435
02-54-603	361	02-58-227	384	02-63-068	435
02-54-661	362	02-58-236	384	02-63-069	435
02-54-665	364	02-58-237	384	02-63-070	435
02-54-666	364	02-58-240	396	02-63-075	436
02-54-668	365	02-58-241	396	02-63-080	437
02-54-669	365	02-58-242	396	02-63-081	437
02-54-761	368	02-58-330	382	02-63-082	437
02-54-770	368	02-58-331	382	02-63-083	437
02-54-771	368	02-58-400	380	02-63-085	437
02-54-772	368	02-58-401	380	02-63-086	437
02-54-775	369	02-58-402	380	02-63-087	437
02-54-776	369	02-58-403	380	02-63-088	437
02-54-777	369	02-58-404	380	02-63-100	490
02-54-799	369	02-58-405	380	02-63-103	441
02-54-800	367	02-58-406	381	02-63-124	445
02-54-801	367	02-58-407	381	02-63-125	445
02-54-803	367	02-58-408	381	02-63-126	445
02-56-020	414	02-58-409	381	02-63-155	443
02-56-042	411	02-58-410	381	02-63-202	432
02-56-043	411	02-58-411	381	02-63-220	433
02-56-044	411	02-58-416	378	02-63-221	433
02-56-045	411	02-58-417	378	02-63-230	289
02-56-048	411	02-58-613	379	02-63-231	289
02-56-049	411	02-58-616	379	02-63-500	489
02-56-050	411	02-58-617	379	02-63-501	489
02-56-051	411	02-58-900	406	02-63-502	489
02-56-060	411	02-58-901	406	02-63-503	489
02-56-061	411	02-60-001	392	02-64-001	267
02-56-062	411	02-60-019	391	02-64-002	267
02-56-063	411	02-60-030	389	02-64-003	267
02-56-064	412	02-60-036	389	02-64-004	267
02-56-065	412	02-60-049	400	02-64-005	267
02-56-110	413	02-60-052	401	02-70-002	203
02-56-111	413	02-60-053	401	02-70-022	200
02-56-112	413	02-60-055	398	02-70-039	202
02-56-113	413	02-60-056	398	02-70-040	202
02-56-114	413	02-60-057	398	02-70-041	202
02-56-115	413	02-60-058	398	02-70-042	202
02-56-116	413	02-60-059	398	02-70-043	202
02-56-117	413	02-60-060	400	02-70-084	248
02-56-118	413	02-60-063	400	02-70-180	211
02-56-119	413	02-60-101	386	02-70-181	211
02-56-400	407	02-60-105	386	02-70-182	211
02-56-434	408	02-60-110	387	02-70-183	211
02-56-460	410	02-60-111	387	02-70-184	211
02-56-463	409	02-60-112	387	02-70-185	211
02-56-464	409	02-60-113	387	02-70-186	211
02-56-465	409	02-60-312	403	02-70-187	211
02-56-466	409	02-60-315	403	02-70-188	211
02-56-467	409	02-63-001	289	02-70-189	211
02-58-012	10	02-63-002	289	02-70-190	209
02-58-013	10	02-63-004	289	02-70-241	218
02-58-014	10	02-63-005	289	02-70-250	220
02-58-015	10	02-63-013	433	02-70-255	219
02-58-016	10	02-63-014	432	02-70-267	221
02-58-017	10	02-63-016	432	02-70-272	237
02-58-090	370	02-63-017	432	02-70-273	237
02-58-100	397	02-63-018	432	02-70-274	237
02-58-101	397	02-63-023	434	02-70-275	237
02-58-102	397	02-63-024	434	02-70-276	237
02-58-106	371	02-63-026	434	02-70-277	222
02-58-107	371	02-63-035	435	02-70-280	223
02-58-110	397	02-63-039	435	02-70-281	223

Seite		Seite		Seite	
02-70-282223	02-72-221196	05-13-118263
02-70-283223	02-72-222196	05-13-119263
02-70-284223	02-72-223196	05-13-120263
02-70-285223	02-72-224196	05-13-121263
02-70-290224	02-72-225196	05-13-122263
02-70-291224	02-72-226196	05-13-123263
02-70-292224	02-72-249195	05-13-124263
02-70-293224	02-72-257197	05-13-125263
02-70-294224	02-72-258197	05-13-126263
02-70-295224	02-72-259197	05-13-127263
02-70-296224	02-72-260197	05-13-128263
02-70-297224	02-72-261197	05-13-129263
02-70-368230	02-72-262197	05-13-130263
02-70-464232	02-72-263197	05-13-131263
02-70-530239	02-72-270198	05-13-132263
02-70-550217	02-72-271198	05-13-133263
02-70-560175	02-72-272199	05-13-134263
02-70-561175	02-72-630149	05-13-135263
02-70-562175	04-15-518475	05-13-136263
02-70-563175	04-16-031488	05-13-137263
02-70-564175	04-16-035488	05-13-138263
02-70-616214	04-16-530492	05-13-139263
02-70-634235	04-16-551492	05-13-140263
02-70-635235	04-16-552492	05-13-141263
02-70-654231	05-01-012423	05-13-142263
02-70-745206	05-01-015423	05-13-143263
02-70-751207	05-01-016423	05-13-144263
02-70-760207	05-01-017423	05-13-145263
02-70-764207	05-01-018423	05-13-146263
02-70-765207	05-01-020424	05-13-147263
02-70-766207	05-01-025423	05-13-231262
02-70-767207	05-01-026423	05-13-232262
02-70-768207	05-01-028429	05-13-233262
02-70-769207	05-01-030425	05-13-234262
02-70-770208	05-01-031425	05-13-235262
02-70-771208	05-01-033425	05-13-236262
02-70-772208	05-01-040427	05-13-237262
02-70-773208	05-01-041427	05-13-238262
02-70-774208	05-01-042427	05-13-239262
02-70-775208	05-01-050426	05-15-180429
02-70-776208	05-01-052426	05-15-216428
02-70-777208	05-01-061428	05-15-33880
02-70-970178	05-01-062428	05-15-34080
02-70-971178	05-01-092424	05-20-141347
02-70-972178	05-01-095424	05-51-013423
02-70-973178	05-01-096424	05-51-016423
02-70-974178	05-01-097424	05-51-017423
02-70-975178	05-01-099424	05-51-019423
02-70-976180	05-02-003402	05-51-040416
02-70-977180	05-02-220422	05-51-041416
02-72-001188	05-10-183320	05-51-043427
02-72-002188	05-10-192321	05-51-048426
02-72-003187	05-10-194321	05-51-049426
02-72-004187	05-10-196321	05-51-060428
02-72-005187	05-10-198321	05-52-874451
02-72-006187	05-12-870236	05-60-184320
02-72-010189	05-12-872236	05-60-185320
02-72-011189	05-12-873236	05-60-195321
02-72-032189	05-13-101263	05-60-199321
02-72-081193	05-13-102263	05-60-200321
02-72-082193	05-13-103263	05-60-201321
02-72-083193	05-13-104263	05-60-202321
02-72-085193	05-13-105263	05-60-203321
02-72-086193	05-13-106263	05-60-204321
02-72-087193	05-13-107263	05-60-205321
02-72-088193	05-13-108263	05-60-206321
02-72-089193	05-13-109263	05-63-001262
02-72-100190	05-13-110263	05-63-002262
02-72-101190	05-13-111263	05-63-010263
02-72-102190	05-13-112263	05-63-011263
02-72-103190	05-13-113263	05-63-019262
02-72-104190	05-13-114263	05-63-021262
02-72-210195	05-13-115263	05-63-023262
02-72-211195	05-13-116263	05-63-025262
02-72-220196	05-13-117263	06-02-030242

Seite	Seite	Seite
06-02-031242, 243	06-02-401T123	06-02-469T63
06-02-032242	06-02-402122	06-02-47081
06-02-033242	06-02-402T123	06-02-47172
06-02-034242	06-02-403122	06-02-47272
06-02-035242	06-02-403T123	06-02-47372
06-02-036242	06-02-404122	06-02-47574
06-02-037242	06-02-404T123	06-02-47673
06-02-038242	06-02-405122	06-02-47773
06-02-040242	06-02-405T123	06-02-47873
06-02-050243	06-02-406124	06-02-48072
06-02-051243	06-02-407124	06-02-480T72
06-02-053243	06-02-408124	06-02-48176
06-02-054243	06-02-411122	06-02-481T76
06-02-055243	06-02-411T123	06-02-48276
06-02-108244	06-02-412122	06-02-48383
06-02-109244	06-02-412T123	06-02-48485
06-02-110244	06-02-414124	06-02-48585
06-02-112244	06-02-414T125	06-02-48682
06-02-113244	06-02-415124	06-02-48782
06-02-114244	06-02-415T125	06-02-48870
06-02-115244	06-02-416124	06-02-48970
06-02-116244	06-02-416T125	06-02-49071
06-02-117244	06-02-417124	06-02-490T71
06-02-119245	06-02-417T125	06-02-49171
06-02-120246	06-02-4204	06-02-49271
06-02-121246	06-02-4214	06-02-492T71
06-02-122246	06-02-4224	06-02-49375
06-02-124247	06-02-4234	06-02-49475
06-02-125247	06-02-4244	06-02-49569
06-02-126247	06-02-4254	06-02-49682
06-02-150252	06-02-4264	06-02-49784
06-02-151252	06-02-4274	06-02-50078
06-02-153316	06-02-4318	06-02-500T78
06-02-154316	06-02-4327	06-02-50178
06-02-155316	06-02-4337	06-02-501T78
06-02-156316	06-02-4347	06-02-50278
06-02-158266	06-02-4357	06-02-502T78
06-02-159266	06-02-4367	06-02-50378
06-02-160258	06-02-4377	06-02-503T78
06-02-161258	06-02-44034	06-02-50478
06-02-162258	06-02-44134	06-02-504T78
06-02-163258	06-02-44234	06-02-50679
06-02-164258	06-02-44334	06-02-506T79
06-02-165258	06-02-44433	06-02-50779
06-02-166259	06-02-44533	06-02-507T79
06-02-167259	06-02-44662	06-02-50879
06-02-168259	06-02-44762	06-02-508T79
06-02-169259	06-02-44862	06-02-51065
06-02-170259	06-02-44962	06-02-51165
06-02-172259	06-02-45246	06-02-51265
06-02-22220	06-02-45346	06-02-512T65
06-02-22320	06-02-45446	06-02-51365
06-02-22420	06-02-45546	06-02-513T65
06-02-23420	06-02-45646	06-02-51564
06-02-23520	06-02-45746	06-02-51664
06-02-23620	06-02-45850	06-02-51764
06-02-24020	06-02-458T50	06-02-51864
06-02-24220	06-02-45950	06-02-51966
06-02-24620	06-02-459T50	06-02-52066
06-02-24820	06-02-46051	06-02-52140
06-02-32812	06-02-460T51	06-02-52240
06-02-32912	06-02-46150	06-02-52341
06-02-33012	06-02-46250	06-02-52441
06-02-33112	06-02-46356	06-02-52569
06-02-35212	06-02-463T56	06-02-52633
06-02-35312	06-02-46456	06-02-52733
06-02-3578	06-02-464T56	06-02-52835
06-02-3588	06-02-46556	06-02-52935
06-02-3598	06-02-465T56	06-02-53035
06-02-394127	06-02-46655	06-02-53233
06-02-395127	06-02-46763	06-02-53333
06-02-396127	06-02-467T63	06-02-53433
06-02-400122	06-02-46863	06-02-53533
06-02-400T123	06-02-468T63	06-02-54038
06-02-401122	06-02-46963	06-02-54138

Seite		Seite		Seite	
06-02-542	39	06-02-725	110	06-02-870	449
06-02-543	38	06-02-726	110	06-02-872	450
06-02-544	39	06-02-727	110	06-02-873	450
06-02-552	42	06-02-729	105	06-02-878	452
06-02-553	43	06-02-730	105	06-02-882	453
06-02-554	44	06-02-731	108	06-02-883	454
06-02-557	52	06-02-731T	108	06-02-890	455
06-02-558	52	06-02-732	108	06-02-892	454
06-02-559	52	06-02-732T	108	06-02-911	449
06-02-559T	52	06-02-733	109	06-02-918	471
06-02-560	52	06-02-734	109	06-02-930	427
06-02-560T	52	06-02-735	109	06-02-934	425
06-02-561	52	06-02-736	113	06-02-938	423
06-02-561T	52	06-02-736T	113	06-02-950	418
06-02-563	71	06-02-737	113	06-02-951	418
06-02-567	45	06-02-737T	113	06-02-952	418
06-02-568	45	06-02-738	103	06-02-960	419
06-02-569	45	06-02-741	96	06-02-961	419
06-02-573	37	06-02-742	96	06-02-971	179
06-02-573T	37	06-02-743	97	06-02-972	179
06-02-574	37	06-02-765	103	06-02-973	179
06-02-574T	37	06-02-776	112	06-02-974	179
06-02-576	77	06-02-777	112	06-02-975	179
06-02-578	68	06-02-778	112	06-02-976	179
06-02-578T	68	06-02-779	112	06-03-040	137
06-02-581	88	06-02-780	112	06-03-041	140
06-02-582	88	06-02-784	126	06-03-042	140
06-02-590	89	06-02-785	126	06-03-043	140
06-02-591	89	06-02-800	148	06-03-044	140
06-02-592	89	06-02-802	149	06-03-060	168
06-02-593	89	06-02-803	149	06-03-061	168
06-02-600	420	06-02-804	149	06-03-062	169
06-02-602	420	06-02-805	158	06-03-063	169
06-02-604	421	06-02-806	159	06-03-064	169
06-02-605	421	06-02-807	159	06-03-300	60
06-02-633	394	06-02-808	154	06-03-301	60
06-02-634	394	06-02-809	154	06-03-302	60
06-02-635	394	06-02-810	155	06-03-303	60
06-02-637	422	06-02-811	155	06-03-304	60
06-02-638	422	06-02-812	155	06-03-310	61
06-02-639	422	06-02-813	155,157	06-03-311	61
06-02-651	256	06-02-814	156	06-03-312	61
06-02-652	256	06-02-815	156	06-03-313	61
06-02-653	256	06-02-816	157	06-03-314	61
06-02-654	256	06-02-817	157	06-03-411	128
06-02-682	255	06-02-818	157	06-03-412	128
06-02-700	92	06-02-819	157	06-03-413	128
06-02-701	92	06-02-820	160	06-03-418	128
06-02-702	92	06-02-821	160	06-04-011	276
06-02-703	93	06-02-822	161	06-04-012	276
06-02-704	93	06-02-823	161	06-04-013	276
06-02-706	94	06-02-830	138	06-04-014	276
06-02-707	92	06-02-835	141	06-04-015	276
06-02-708	94	06-02-836	140	06-04-016	276
06-02-710	106	06-02-840	171	06-04-017	276
06-02-710T	106	06-02-841	172	06-04-018	276
06-02-711	106	06-02-842	172	06-04-019	276
06-02-712	106	06-02-844	172	06-04-020	276
06-02-712T	106	06-02-845	162	06-04-021	276
06-02-713	107	06-02-846	162	06-04-022	276
06-02-713T	107	06-02-847	148	06-04-023	276
06-02-714	106	06-02-850	145	06-04-024	276
06-02-715	107	06-02-851	145	06-04-025	276
06-02-715T	107	06-02-852	142	06-04-028	276
06-02-717	104	06-02-853	142	06-04-045	286
06-02-718	104	06-02-854	143	06-04-046	287
06-02-719	104	06-02-855	143	06-04-076	278
06-02-721	111	06-02-856	143	06-04-079	278
06-02-721T	111	06-02-857	143	06-04-080	278
06-02-722	111	06-02-858	143	06-04-081	278
06-02-722T	111	06-02-860	176	06-04-100	274
06-02-723	111	06-02-861	176	06-04-100T	275
06-02-723T	111	06-02-862	176	06-04-101	274
06-02-724	111	06-02-865	177	06-04-101T	275
06-02-724T	111	06-02-866	177	06-04-103	274

Seite	Seite	Seite
06-04-103T275	06-04-61525	06-11-400479
06-04-117274	06-04-63424	06-11-401479
06-04-230280	06-04-63524	06-11-402480
06-04-231280	06-04-63624	06-11-403480
06-04-232282	06-04-67125	06-11-408481
06-04-233282	06-04-67225	06-11-409481
06-04-240280	06-04-67325	06-11-420476
06-04-240T281	06-04-67425	06-11-611469
06-04-241280	06-05-00527	06-11-612469
06-04-241T281	06-05-01027	06-11-613469
06-04-242282	06-05-01127	06-11-614469
06-04-242T283	06-05-01227	06-11-615469
06-04-243282	06-05-01327	06-11-616469
06-04-243T283	06-05-01427	06-11-617469
06-04-244280	06-05-02027	06-11-621468
06-04-244T281	06-05-02127	06-11-622468
06-04-245280	06-05-02227	06-11-623468
06-04-245T281	06-05-02327	06-11-624468
06-04-246282	06-05-02427	06-11-625468
06-04-246T283	06-06-300254	06-11-626468
06-04-247282	06-06-301253	06-11-627468
06-04-247T283	06-06-302253	06-11-630470
06-04-249282	06-06-303252	06-11-631470
06-04-280292	06-06-310252	06-11-632470
06-04-281292	06-06-313248	06-11-633470
06-04-284292	06-06-321248	06-11-634470
06-04-284T293	06-06-322248	06-11-635470
06-04-285292	06-06-349253	06-11-636470
06-04-285T293	06-06-774183	06-11-637470
06-04-286292	06-06-775183	06-11-638470
06-04-286T293	06-06-777183	06-11-639470
06-04-287292	06-06-778183	06-12-036471
06-04-287T293	06-06-799183	06-12-037471
06-04-288292	06-06-800183	06-15-120466
06-04-302252	06-06-801183	06-15-127466
06-04-306251	06-06-803183	06-15-130466
06-04-307251	06-06-805183	06-15-135467
06-04-308251	06-06-806183	06-15-136467
06-04-310251	06-06-807183	06-15-500456
06-04-311251	06-06-810183	06-15-502456
06-04-312251	06-06-811183	06-15-514456
06-04-332252	06-06-814183	06-15-515456
06-04-333252	06-11-301472	06-15-520457
06-04-334252	06-11-302472	06-15-521457
06-04-396249	06-11-306472	06-15-522460
06-04-397249	06-11-307472	06-15-523460
06-04-398249	06-11-308472	06-15-525460
06-04-399249	06-11-309472	06-15-530458
06-04-429252	06-11-317485	06-15-532459
06-04-51727	06-11-318485	06-15-550458
06-04-51927	06-11-319485	06-15-551458
06-04-55224	06-11-321485	06-15-555460
06-04-55424	06-11-323485	06-15-566458
06-04-55624	06-11-324485	06-15-570459
06-04-55824	06-11-325485	06-15-572459
06-04-56024	06-11-340474	06-15-601461
06-04-56124	06-11-341474	06-15-602461
06-04-56224	06-11-344474	06-15-610463
06-04-56826	06-11-345474	06-15-611463
06-04-56926	06-11-355473	06-15-614463
06-04-57024	06-11-356473	06-15-620462
06-04-57424	06-11-357473	06-15-622462
06-04-57524	06-11-358473	06-15-624462
06-04-57624	06-11-359473	06-15-626462
06-04-57826	06-11-360475	06-15-632462
06-04-600274	06-11-361475	06-15-634462
06-04-600T275	06-11-362473	06-15-636462
06-04-601274	06-11-379475	06-15-640464
06-04-601T275	06-11-381482	06-15-641464
06-04-603274	06-11-382482	06-15-645465
06-04-603T275	06-11-383482	06-15-646464
06-04-61125	06-11-384483	06-15-647465
06-04-61225	06-11-387483	06-15-648464
06-04-61325	06-11-390475	06-15-649465
06-04-61425	06-11-391475	06-20-00218

Seite	Seite	Seite			
06-20-007	18	06-52-170	259	06-52-300T	2
06-52-008	245	06-52-172	259	06-52-301T	2
06-52-010	245	06-52-175	261	06-52-302T	2
06-52-012	245	06-52-180	260	06-52-303T	2
06-52-013	245	06-52-181	260	06-52-304T	2
06-52-014	245	06-52-182	260	06-52-305T	2
06-52-015	245	06-52-183	260	06-52-306T	2
06-52-016	245	06-52-184	260	06-52-307T	2
06-52-017	245	06-52-185	260	06-52-310T	2
06-52-020	264	06-52-186	260	06-52-311T	2
06-52-021	264	06-52-187	260	06-52-312T	2
06-52-022	264	06-52-188	260	06-52-313T	2
06-52-023	264	06-52-189	260	06-52-314T	2
06-52-024	264	06-52-190	260	06-52-315T	2
06-52-025	264	06-52-191	260	06-52-316T	2
06-52-026	264	06-52-192	260	06-52-317T	2
06-52-027	264	06-52-193	260	06-52-320T	2
06-52-028	264	06-52-194	260	06-52-321T	2
06-52-029	264	06-52-195	260	06-52-322T	2
06-52-030	264	06-52-196	260	06-52-323T	2
06-52-040	265	06-52-197	260	06-52-324T	2
06-52-041	265	06-52-198	260	06-52-325T	2
06-52-042	265	06-52-199	260	06-52-326T	2
06-52-043	265	06-52-210	20	06-52-327T	2
06-52-100	122	06-52-211	20	06-52-358	5
06-52-100T	123	06-52-212	20	06-52-359	5
06-52-101	122	06-52-213	20	06-52-360	5
06-52-101T	123	06-52-214	20	06-52-361	5
06-52-102	122	06-52-215	20	06-52-362	5
06-52-103	122	06-52-222	20	06-52-363	5
06-52-104	122	06-52-223	20	06-52-364	5
06-52-105	122	06-52-225	21	06-52-366	6
06-52-106	122	06-52-234	20	06-52-367	6
06-52-106T	123	06-52-235	20	06-52-368	6
06-52-107	122	06-52-236	20	06-52-369	6
06-52-107T	123	06-52-237	21	06-52-370	6
06-52-108	122	06-52-240	20	06-52-371	6
06-52-108T	123	06-52-242	20	06-52-372	6
06-52-109	122	06-52-243	21	06-52-373	6
06-52-109T	123	06-52-246	20	06-52-380	9
06-52-110	124	06-52-248	20	06-52-381	9
06-52-111	124	06-52-249	21	06-52-382	9
06-52-112	124	06-52-250	129	06-52-383	9
06-52-113	124	06-52-251	129	06-52-384	9
06-52-114	124	06-52-252	129	06-52-385	9
06-52-114T	125	06-52-253	129	06-52-386	9
06-52-115	124	06-52-254	130	06-52-387	9
06-52-115T	125	06-52-255	130	06-52-388	9
06-52-116	124	06-52-256	130	06-52-389	9
06-52-116T	125	06-52-257	130	06-52-390	9
06-52-117	124	06-52-258	130	06-52-391	9
06-52-117T	125	06-52-260	131	06-52-410	127
06-52-118	124	06-52-261	131	06-52-411	127
06-52-119	122	06-52-262	131	06-52-412	127
06-52-119T	123	06-52-263	131	06-52-430	7
06-52-120	122	06-52-264	131	06-52-431	7
06-52-120T	123	06-52-265	131	06-52-442	34
06-52-150	257	06-52-266	131	06-52-443	34
06-52-151	257	06-52-267	131	06-52-444	33
06-52-152	257	06-52-268	131	06-52-445	33
06-52-153	257	06-52-269	131	06-52-448	33
06-52-154	257	06-52-270	131	06-52-449	33
06-52-155	257	06-52-271	131	06-52-452	54
06-52-156	257	06-52-272	131	06-52-453	54
06-52-157	257	06-52-273	131	06-52-454	54
06-52-160	258	06-52-274	131	06-52-455	54
06-52-161	258	06-52-275	131	06-52-456	47
06-52-162	258	06-52-276	131	06-52-456T	47
06-52-163	258	06-52-277	131	06-52-457	47
06-52-164	258	06-52-278	131	06-52-457T	47
06-52-165	258	06-52-279	131	06-52-458	47
06-52-166	259	06-52-280	131	06-52-459	47
06-52-167	259	06-52-281	131	06-52-463	51
06-52-168	259	06-52-282	131	06-52-463T	51
06-52-169	259	06-52-283	131	06-52-464	57

Seite	Seite	Seite			
06-52-465.....	57	06-52-591.....	116	06-52-803.....	136
06-52-466.....	57	06-52-592.....	117	06-52-804.....	137
06-52-467.....	57	06-52-593.....	117	06-52-805.....	149
06-52-468.....	72	06-52-594.....	117	06-52-806.....	138
06-52-469.....	72	06-52-600.....	98	06-52-807.....	138
06-52-470.....	72	06-52-601.....	98	06-52-808.....	159
06-52-470T.....	72	06-52-602.....	98	06-52-809.....	159
06-52-471.....	72	06-52-603.....	98	06-52-810.....	139
06-52-472.....	74	06-52-604.....	98	06-52-811.....	139
06-52-473.....	83	06-52-605.....	98	06-52-812.....	139
06-52-475.....	86	06-52-606.....	98	06-52-813.....	144
06-52-476.....	86	06-52-607.....	98	06-52-814.....	144
06-52-480.....	87	06-52-608.....	98	06-52-815.....	144
06-52-481.....	87	06-52-610.....	99	06-52-820.....	146
06-52-482.....	87	06-52-611.....	99	06-52-821.....	146
06-52-491.....	75	06-52-612.....	99	06-52-822.....	147
06-52-492.....	75	06-52-613.....	99	06-52-823.....	147
06-52-495.....	69	06-52-614.....	99	06-52-824.....	147
06-52-500.....	36	06-52-615.....	99	06-52-825.....	147
06-52-501.....	36	06-52-616.....	99	06-52-826.....	147
06-52-502.....	36	06-52-617.....	99	06-52-827.....	150
06-52-503.....	48	06-52-618.....	99	06-52-828.....	150
06-52-504.....	48	06-52-620.....	100	06-52-829.....	150
06-52-505.....	48	06-52-621.....	100	06-52-830.....	150
06-52-506.....	48	06-52-622.....	100	06-52-831.....	171
06-52-507.....	49	06-52-623.....	100	06-52-832.....	171
06-52-508.....	49	06-52-624.....	100	06-52-834.....	141
06-52-509.....	49	06-52-625.....	100	06-52-835.....	151
06-52-510.....	49	06-52-626.....	100	06-52-836.....	151
06-52-511.....	55	06-52-627.....	100	06-52-837.....	151
06-52-512.....	58	06-52-628.....	100	06-52-838.....	151
06-52-513.....	58	06-52-630.....	101	06-52-839.....	151
06-52-514.....	59	06-52-631.....	101	06-52-840.....	152
06-52-515.....	59	06-52-632.....	101	06-52-841.....	152
06-52-516.....	66	06-52-633.....	101	06-52-842.....	153
06-52-516T.....	66	06-52-634.....	101	06-52-843.....	153
06-52-517.....	67	06-52-635.....	102	06-52-844.....	153
06-52-520.....	53	06-52-636.....	102	06-52-845.....	170
06-52-521.....	53	06-52-637.....	102	06-52-847.....	163
06-52-522.....	53	06-52-638.....	102	06-52-848.....	163
06-52-523.....	53	06-52-639.....	422	06-52-849.....	164
06-52-530.....	90	06-52-640.....	118	06-52-850.....	164
06-52-531.....	90	06-52-641.....	118	06-52-851.....	164
06-52-532.....	90	06-52-642.....	118	06-52-852.....	145
06-52-533.....	90	06-52-643.....	118	06-52-853.....	145
06-52-534.....	90	06-52-644.....	118	06-52-854.....	145
06-52-535.....	91	06-52-645.....	118	06-52-855.....	165
06-52-536.....	91	06-52-646.....	119	06-52-856.....	166
06-52-537.....	91	06-52-647.....	119	06-52-857.....	166
06-52-538.....	91	06-52-648.....	119	06-52-871.....	450
06-52-540.....	95	06-52-649.....	119	06-52-875.....	451
06-52-541.....	95	06-52-650.....	256	06-52-876.....	452
06-52-542.....	95	06-52-651.....	256	06-52-877.....	453
06-52-543.....	95	06-52-652.....	256	06-52-893.....	454
06-52-544.....	95	06-52-653.....	256	06-52-946.....	417
06-52-545.....	95	06-52-660.....	182	06-52-947.....	417
06-52-550.....	42	06-52-661.....	182	06-52-948.....	417
06-52-551.....	42	06-52-662.....	182	06-52-949.....	417
06-52-552.....	43	06-52-663.....	182	06-52-953.....	419
06-52-553.....	44	06-52-664.....	182	06-52-954.....	419
06-52-573.....	37	06-52-665.....	182	06-54-011.....	277
06-52-573T.....	37	06-52-670.....	181	06-54-012.....	277
06-52-574.....	68	06-52-671.....	181	06-54-013.....	277
06-52-575.....	68	06-52-680.....	255	06-54-014.....	277
06-52-580.....	114	06-52-720.....	108	06-54-015.....	277
06-52-581.....	114	06-52-720T.....	108	06-54-016.....	277
06-52-582.....	114	06-52-721.....	108	06-54-017.....	277
06-52-583.....	115	06-52-721T.....	108	06-54-018.....	277
06-52-584.....	115	06-52-740.....	96	06-54-019.....	277
06-52-585.....	115	06-52-741.....	97	06-54-020.....	277
06-52-586.....	116	06-52-742.....	97	06-54-021.....	277
06-52-587.....	116	06-52-786.....	126	06-54-022.....	277
06-52-588.....	116	06-52-800.....	136	06-54-023.....	277
06-52-589.....	116	06-52-801.....	136	06-54-024.....	277
06-52-590.....	116	06-52-802.....	136	06-54-025.....	277

Seite	Seite	Seite			
06-54-028	277	06-54-261	284	06-54-935	132
06-54-045	286	06-54-262	284	06-54-935T	133
06-54-046	287	06-54-263	284	06-54-936	132
06-54-076	279	06-54-264	284	06-54-936T	133
06-54-079	279	06-54-265	284	06-54-937	290
06-54-080	279	06-54-266	284	06-54-937T	291
06-54-081	279	06-54-267	284	06-54-938	290
06-54-115	274	06-54-270	285	06-54-938T	291
06-54-115T	275	06-54-271	285	06-54-939	290
06-54-116	274	06-54-272	285	06-54-939T	291
06-54-116T	275	06-54-273	285	06-54-940	290
06-54-117	288	06-54-274	285	06-54-940T	291
06-54-118	288	06-54-275	285	06-54-941	290
06-54-120	272	06-54-276	285	06-54-941T	291
06-54-121	272	06-54-277	285	06-54-942	290
06-54-122	272	06-54-280	292	06-54-942T	291
06-54-123	272	06-54-281	292	06-54-943	290
06-54-124	272	06-54-284	292	06-54-943T	291
06-54-125	273	06-54-284T	293	06-54-944	290
06-54-126	273	06-54-285	292	06-54-944T	291
06-54-127	273	06-54-285T	293	06-54-945	290
06-54-128	273	06-54-286	292	06-54-945T	291
06-54-129	273	06-54-286T	293	06-54-946	290
06-54-130	270	06-54-287	292	06-54-946T	291
06-54-131	270	06-54-287T	293	06-54-947	290
06-54-132	270	06-54-288	292	06-54-947T	291
06-54-133	270	06-54-288T	293	06-54-948	290
06-54-134	270	06-54-289	292	06-54-948T	291
06-54-135	271	06-54-289T	293	06-54-950	294
06-54-136	271	06-54-290	292	06-54-951	294
06-54-137	271	06-54-290T	293	06-54-952	294
06-54-138	271	06-54-291	292	06-54-953	294
06-54-139	271	06-54-291T	293	06-54-954	294
06-54-200	286	06-54-293	292	06-54-955	294
06-54-201	286	06-54-313	250	06-54-960	294
06-54-202	286	06-54-314	250	06-54-961	294
06-54-203	286	06-54-315	250	06-54-962	294
06-54-204	286	06-54-316	250	06-54-963	294
06-54-205	286	06-54-317	250	06-54-964	294
06-54-206	287	06-54-680	28	06-54-965	294
06-54-207	287	06-54-681	28	06-54-970	295
06-54-208	287	06-54-682	28	06-54-971	295
06-54-209	287	06-54-683	28	06-54-972	295
06-54-210	288	06-54-684	28	06-54-973	295
06-54-211	288	06-54-685	28	06-54-974	295
06-54-212	288	06-54-686	28	06-54-975	295
06-54-213	288	06-54-687	28	06-54-980	134
06-54-214	288	06-54-688	29	06-54-981	134
06-54-215	288	06-54-689	29	06-54-982	134
06-54-216	288	06-54-690	29	06-54-983	134
06-54-217	288	06-54-691	29	06-54-984	134
06-54-218	288	06-54-695	30	06-54-985	134
06-54-219	288	06-54-696	30	06-55-010	19
06-54-220	288	06-54-697	30	06-55-520	17
06-54-221	288	06-54-698	30	06-55-522	17
06-54-222	288	06-54-925	132	06-55-522T	17
06-54-223	288	06-54-925T	133	06-55-524	17
06-54-224	289	06-54-926	132	06-55-524T	17
06-54-225	289	06-54-926T	133	06-55-526	17
06-54-226	289	06-54-927	132	06-55-528	17
06-54-227	289	06-54-927T	133	06-55-528T	17
06-54-228	289	06-54-928	132	06-55-529	17
06-54-229	289	06-54-928T	133	06-55-529T	17
06-54-248	280	06-54-929	132	06-56-760	183
06-54-248T	281	06-54-929T	133	06-56-761	183
06-54-250	282	06-54-930	132	06-56-762	183
06-54-250T	283	06-54-930T	133	06-56-763	183
06-54-251	280	06-54-931	132	06-56-764	183
06-54-251T	281	06-54-931T	133	06-56-769	183
06-54-252	280	06-54-932	132	06-56-770	183
06-54-253	282	06-54-932T	133	06-56-771	183
06-54-253T	283	06-54-933	132	06-56-772	183
06-54-254	282	06-54-933T	133	06-56-773	183
06-54-255	280	06-54-934	132	06-56-774	183
06-54-260	284	06-54-934T	133	06-56-775	183

Seite		Seite		Seite	
06-56-777183	07-56-809311	12-74-170487
06-56-800183	07-56-810311	12-74-171487
06-56-801183	07-56-850319	12-74-172487
06-56-802183	07-56-851319	15-01-310210
06-56-803183	07-56-852319	15-01-311210
06-56-804183	07-56-853319	15-01-312210
06-56-805183	07-56-854319	15-01-313210
06-56-806183	07-56-855319	15-01-314210
06-56-807183	07-56-856319	15-03-020350
06-56-808183	07-56-857319	15-03-021350
06-56-809183	07-56-858319	15-03-022350
06-56-810183	07-56-859319	15-12-162254
06-56-811183	07-56-860319	15-12-163254
06-56-812183	07-56-861319	15-12-165254
06-56-814183	07-56-863309	15-12-166254
06-56-815183	07-56-868315	15-12-170254
06-56-816183	07-56-900316	15-12-611248
06-56-817183	07-56-902316	15-12-612248
06-56-818183	07-56-915317	15-12-619248
06-61-326484	07-56-916317	15-12-626248
06-61-327484	07-56-917317	15-12-627248
06-61-380475	07-56-918317	15-13-489334
06-61-419476	07-56-919317	65 18016
06-61-420476	07-56-920317	65 180T16
06-61-421477	07-56-921317	65 18216
06-61-422477	07-56-922317	65 182T16
06-61-423478	07-56-927318	65 19016
06-61-424478	07-56-930318	65 190T16
06-61-610469	07-56-931318	65 19216
06-61-618469	07-56-933318	65 192T16
06-61-619469	07-56-934318	65 19416
06-62-710471	07-56-935318	65 194T16
06-62-711471	07-56-936318	65 20016
06-62-712471	07-56-937318	65 200T16
06-65-500456	07-56-938318	65 21016
06-65-501456	07-56-939318	65 210T16
06-65-502456	07-56-940318	65 21116
06-65-510461	07-56-943312	65 211T16
06-65-511461	07-56-945312	65 21216
06-65-512461	07-56-946312	65 212T16
06-65-517457	07-56-947312	65 21316
06-65-524460	07-56-948312	65 213T16
06-65-531459	07-56-949313	65 21416
06-65-536459	10-57-001261	65 214T16
06-65-537459	10-57-002261	65 21616
06-65-553458	10-57-003261	65 216T16
06-65-554458	11-25-002486	65 21716
06-65-556458	11-25-003486	65 217T16
06-65-631462	11-25-004486	65 22016
06-65-650465	11-25-005486	65 220T16
07-06-860309	11-25-006486	65 22216
07-06-862309	11-25-007486	65 222T16
07-06-867315	11-25-008486	65 22416
07-06-927318	11-25-009486	65 224T16
07-06-928318	11-25-010486	65 22616
07-06-929318	11-25-012486	65 226T16
07-06-930318	11-25-015486	65 22716
07-06-931318	12-24-157494	65 227T16
07-06-939317	12-24-158494	65 22816
07-06-940317	12-24-159493	65 228T16
07-06-941317	12-24-170488	65 24014
07-06-942317	12-24-171488	65 240T14
07-06-944312	12-24-172489	65 24214
07-06-946313	12-24-176490	65 242T14
07-06-947313	12-24-181487	65 24414
07-06-948313	12-24-182487	65 244T14
07-56-800310	12-24-183487	65 24814
07-56-801310	12-24-185487	65 248T14
07-56-802310	12-74-154495	65 25014
07-56-803314	12-74-155495	65 250T14
07-56-804314	12-74-156494	65 25214
07-56-805311	12-74-160493	65 252T14
07-56-806311	12-74-161486	65 25414
07-56-807311	12-74-162486	65 254T14
07-56-808311	12-74-163486	65 25814

Seite	Seite	Seite
65 258T14	65 74213	90-80-39122
65 26014	65 742T13	90-80-39622
65 260T14	65 74413	90-80-39722
65 26214	65 744T13	90-80-39822
65 262T14	65 74813	90-80-39922
65 26414	65 748T13	90-80-40022
65 264T14	65 75013	90-80-40122
65 28014	65 750T13	90-80-40222
65 280T14	65 75213	90-80-40322
65 28214	65 752T13	90-80-40422
65 282T14	65 75413	90-80-40522
65 28414	65 754T13	90-80-40622
65 284T14	65 75813	90-80-40722
65 28614	65 758T13	90-80-40822
65 286T14	65 76013	90-80-40922
65 29014	65 760T13	90-80-41022
65 290T14	65 76213	90-80-41122
65 29214	65 762T13	90-80-41222
65 292T14	65 76413	90-80-41322
65 30616	65 764T13	90-80-41422
65 306T16	65 78013	90-80-41522
65 30716	65 780T13	90-80-41622
65 307T16	65 78213	90-80-41722
65 32314	65 782T13	90-80-41822
65 323T14	65 78413	90-80-41922
65 32414	65 784T13	90-80-50022
65 324T14	65 78613	90-80-50122
65 32514	65 786T13	90-80-50222
65 325T14	65 79013	90-80-50322
65 34014	65 790T13	90-80-50422
65 340T14	65 79213	90-80-50522
65 39514	65 792T13	90-80-50622
65 395T14	65 80615	90-80-50722
65 39614	65 806T15	90-80-50822
65 396T14	65 80715	90-80-50922
65 68015	65 807T15	
65 680T15	65 82313	
65 68215	65 823T13	
65 682T15	65 82413	
65 69015	65 824T13	
65 690T15	65 82513	
65 69215	65 825T13	
65 692T15	65 84013	
65 69415	65 840T13	
65 694T15	65 89513	
65 70015	65 895T13	
65 700T15	65 89613	
65 71015	65 896T13	
65 710T15	90-80-07123	
65 71115	90-80-07223	
65 711T15	90-80-07323	
65 71215	90-80-07523	
65 712T15	90-80-07623	
65 71315	90-80-07723	
65 713T15	90-80-19622	
65 71415	90-80-19722	
65 714T15	90-80-19822	
65 71615	90-80-24422	
65 716T15	90-80-24522	
65 71715	90-80-24622	
65 717T15	90-80-28622	
65 72015	90-80-28722	
65 720T15	90-80-28822	
65 72215	90-80-28922	
65 722T15	90-80-29222	
65 72415	90-80-29322	
65 724T15	90-80-32322	
65 72615	90-80-32422	
65 726T15	90-80-32522	
65 72715	90-80-32622	
65 727T15	90-80-32722	
65 72815	90-80-32822	
65 728T15	90-80-32922	
65 74013	90-80-33022	
65 740T13	90-80-39022	

Rebstock Instruments GmbH

In Weiheräcker 7

D-78589 Dürbheim/Tuttlingen · Germany

Tel. +49 (0) 74 24 / 67 34

Fax +49 (0) 74 24 / 43 34

info@rebstock.de

www.rebstock.de