

STILLE Surgical Instruments



Kirurgisk perfektion i över 175 år

I över 175 år har vi utvecklat och tillverkat de bästa kirurgiska instrumenten till världens mest krävande kirurger. Vi vill rikta ett stort tack till alla våra trogna kunder och samtidigt välkomna våra nya kunder. I den här katalogen presenterar vi vårt kompletta sortiment av STILLES original instrument.

Precision, hållbarhet och känsla är typiska egenskaper för alla STILLE-instrument. Den stora majoriteten är handgjorda av våra skickliga instrumentmakare Eskilstuna. Instrumentets resa från rundstål till ett färdigt instrument är lång, och består av många tillverkningssteg. STILLES unika tillverkningsmetod och användning av enbart det bästa materialet ger våra instrument deras unika känsla och hållbarhet.

I det första kapitlet hittar du våra saxar, allt från vanliga operationssaxar till våra unika SuperCut och Diamond SuperCut-saxar. Du hittar även STILLES pincetter, våra eleganta nålförare, peanger, klämmare, tänger, kyretter och hakar samt ett brett sortiment av mikroinstrument i både rostfritt stål och titan. Gemensamt för instrumenten är att de alla är smidiga med lätt gång. Deras balans, eleganta utformning och ergonomi möjliggör långa och komplicerade ingrepp med största säkerhet.

Fortfarande är vi mest stolta över att ha utvecklat världens första dubbelledade gougetång. Vi uppfann även världens första osteotom med det klassiska 8-kantiga handtaget. Båda har sedan dess kopierats många gånger, men en kopia kan aldrig mäta sig med originalet.

Kännetecknen för STILLES instrument är att de är lätta och gracila och fungerar perfekt under ingrepp som kräver extrem precision. Instrumenten blir en naturlig förlängning av kirurgens hand. Alltid med ett perfekt resultat.



Surgical Perfection for over 175 years

For over 175 years, we have developed and manufactured the best surgical instruments for the world's most demanding surgeons. We would like to extend a heartfelt thank you to all our loyal customers and a warm welcome to our new customers. In this catalog we present our complete range of STILLE original surgical instruments.

Precision, durability and feel are characteristic qualities of all STILLE instruments. The vast majority are handcrafted by our highly skilled instrument makers in Eskilstuna, west of Stockholm, Sweden. The instruments' journey from a rod of stainless steel to a finished instrument is a long one, involving multiple stages. STILLE's unique method of crafting its instrument materials, and its usage of only the very highest-grade steels, give our instruments their unique feel and durability.

In the first chapter, you will find our line of scissors, everything from common surgical models to our unique original SuperCut and Diamond SuperCut scissors. You'll also find STILLE forceps, our elegant needle holders, artery forceps, clamps, rongeurs, curettes and retractors as well as a wide range of micro instruments made of stainless steel and titanium. Common to all of our instruments is that they are smooth and easy to operate. Their outstanding balance, elegant design and ergonomics allow long and complex procedures with the utmost security.

We are still proud to have developed the world's first double-action bone rongeur. We also invented the world's first osteotome with the classic 8-sided handle. Both instruments have since then been copied many times, but a copy can't measure up to the original.

STILLE instruments are known to be light and graceful and to function perfectly during procedures requiring extreme precision. The instruments become a natural extension of the surgeon's hand – and the result is always perfect.

Innehåll | Table of contents | Inhaltsverzeichnis | Indice | Tabla de contenido | 目次

12 Saxar | Scissors | Scheren | Forbici | Tijeras | 剪刀 (はさみ)

- 16 Ögonsaxar | Eye Scissors | Augenscheren | Forbici oculistiche | Tijeras oculares | 眼科剪刀
- 17 Ögonlockssaxar | Blepharoplasty Scissors | Blepharoplastik-Scheren | Forbici per blefaroplastica | Tijeras de Blefaroplastia | 眼瞼形成用剪刀
- 18 Dissektionssaxar | Dissecting scissors | Präparierscheren | Forbici da dissezione | Tijeras para disección | 剥離・切離用剪刀
- 33 Operationsaxar | Operating scissors | Chirurgische Scheren | Forbici chirurgiche | Tijeras para cirugía | 外科剪刀
- 36 Tenotomisaxar | Tenotomy scissors | Sehenscheren | Forbici per tenotomia | Tijeras para tenotomia | 腱切除用剪刀
- 40 Kärlsaxar | Vascular scissors | Gefässcheren | Forbici vascolari | Tijeras vasculares | 血管剪刀
- 42 Nässaxar | Nasal scissors | Nasenscheren | Forbici nasali | Tijeras nasales | 鼻用剪刀
- 46 Face-lift saxar | Face-lift scissors | Face-lift Scheren | Forbici face-lift | Tijeras face-lift | フェイスリフト用剪刀
- 49 Trådföringssaxar | Suture carrying scissors | Fadenführungsscheren | Forbici portafilo | Tijeras portahilos | 縫合糸保持剪刀
- 50 Sutursaxar | Suture scissors | Fadenscheren | Cesoié per suture | Cizallas para suturas | 抜糸用剪刀

52 Pincetter | Forceps | Pinzetten | Pinze | Pinzas | 鑷子 (ピンセット)

- 54 Pincetter | Forceps | Pinzetten | Pinze | Pinzas | 鑷子 (ピンセット)
- 57 Anatomiska pincetter | Dressing forceps | Anatomische Pinzetten | Pinze anatomiche da dissezione | Pinzas de disección | 包帶鑷子
- 59 Durapincetter | Dura forceps | Durapinzetten | Pinze per dura madre | Pinzas para dura-madre | 硬膜鑷子または5爪鑷子
- 60 Irispincetter | Iris forceps | Irispinzetten | Pinze per iride | Pinzas para iris | 眼科鑷子
- 61 Kärlpincetter | Vascular forceps | Gefässpinzetten | Pinze vascolari | Pinzas vasculares | 血管鑷子
- 62 Diatermipincetter | Diathermy forceps | Diathermiepinzetten | Pinze per diatermia | Pinzas para diatermia | ジアテルミー鑷子
- 63 Knutpincetter | Knot-holding forceps | Knüpfpinzetten | Pinze per nodi | Pinzas para nudos | 結び目保持鑷子

64 Peanger | Artery forceps | Arterienklemmen | Pinze emostatiche | Pinzas hemostáticas | 止血鉗子

- 66 Peanger | Artery forceps | Arterienklemmen | Pinze emostatiche | Pinzas hemostáticas | 止血鉗子
- 78 Artär- och ligaturklämmare | Artery and ligature clamps | Arterien- und Ligaturklemmen | Pinzas per arterie e legature | Pinzas para arterias y ligaduras | 結紮鉗子および剥離鉗子

80 Nålförare | Needle holders | Nadelhalter | Portaghi | Porta-agujas | 持針器

- 82 **Nålförare storlekstabell** | Needle holder in relation to suture size | Nadelhalter in Relation zur Stärke des Nahtmaterials | Il portaaghi in relazione alla misura della sutura | Porta-agujas en relación al tamaño de la sutura | 縫合糸サイズに適する持針器
- 83 **Nålförare** | Needle holders | Nadelhalter | Portaghi | Porta-agujas | 持針器
- 92 **Knuthållartänger** | Knot-holding Forceps | Knüpfzangen | Pinze portanodi | Pinzas para atar nudos | 結び目保持鉗子
- 93 **Ståltrådsroterare & hållare** | Wire Twisting & Holding Forceps | Draht-Dreh- und Haltezange | Pinza serra-fili | Pinzas cierra-hilos y pinzas para extraer alambres | ワイヤークルマ

94 Bentänger | Bone cutters and rongeurs | Knochen & hohlmeisselzangen | Cesoié per ossa & pinze sgorbie | Pinzas cortantes & pinzas-gubias | 骨剪刀および骨鉗子(ロンジュール)

- 96 **Plattänger** | Flat pliers | Flachzangen | Tenaglia piatta | Alicates planos | ペンチ(シングルアクション)
- 97 **Extraktionstänger** | Extraction pliers | Extraktionszangen | Pinze d'estrazione | Pinzas de extracción | ペンチ(ダブルアクション)
- 98 **Benavbitare** | Bone cutting forceps | Knochensplitterzangen | Cesoié per ossa | Pinzas cortantes | 骨切り鉗子
- 100 **Gougetänger** | Bone rongeurs | Hohlmeisselzangen | Pinze-sgorbie | Pinzas-gubias | 骨鉗子(ロンジュール)
- 108 **Benhållartänger** | Bone holding forceps | Knochenhalte-zangen | Tenaglie per ossa | Pinzas para hueso | 骨保持鉗子
- 109 **Trådavbitare** | Wire cutters | Drahtkneifzangen | Tenaglie tagliafili | Alicates corta-alambres | ワイヤークッター
- 111 **Laminektomistansar** | Laminectomy punches | Laminektomiestanzen | Pinze taglienti per laminectomia | Pinzas cortantes para laminectomía | 椎弓切除用パンチ(ケリソパンチ)
- 113 **Bittänger** | Rongeurs for intervertebral discs | Bandscheiben-Rongeur | Pinze taglienti per dischi intervertebrali | Pinzas cortantes para discos intervertebrales | 骨鉗子(ボーンロンジュール)

116 Klämmare | Clamps | Klemmen | Pinze | Pinzas | 血管鉗子および組織把持鉗子

- 118 **Colonklämmare** | Colon Clamps | Colonklemmen | Pinze per colon | Pinzas para colon | 結腸鉗子
- 119 **Galltänger** | Gall duct clamps | Gallenkanalklemmen | Pinze per vie biliari | Pinzas para conductos biliares | 胆管クランプ
- 120 **Universalklämmare** | Multi-purpose clamps | Mehrzweckklemmen | Pinze per applicazione universale | Pinzas de múltiple uso | 多目的クランプ
- 123 **Tangential occlusionsklämmare** | Tangential occlusion clamps | Tangential-Verschlussklemmen | Pinze per occlusione tangenziale | Pinzas tangentes de oclusion | 正接鉗子
- 125 **Perifera kärlklämmare** | Peripheral vascular clamps | Peripheralklemmen | Pinze per vasi periferici | Pinzas para vaso periférico | 末梢血管クランプ
- 126 **Anastomosklämmare** | Anastomosis clamps | Anastomosenklemmen | Pinze per anastomosi | Pinzas para anastomosis | 吻合クランプ
- 127 **Aorta anastomosklämmare** | Aortic-anastomosis clamps | Aorten-Anastomosenklemmen | Pinze per anastomosi dell'aorta | Pinzas para anastomosis aórtica | 大動脈吻合クランプ

- 128 **Aorta-aneurysmklämmare** | Aortic-aneurysm clamps | Aorten-Aneurysmenklemmen | Pinze per aneurisme aortiche | Pinzas de aneurisma aórtica | 大動脈瘤クランプ
- 129 **Carotisklämmare** | Carotid clamps | Carotisklemmen | Pinze carotidee | Pinzas para carótida | 頸動脈クランプ
- 130 **Profunda arteria femoralis klämmare** | Profunda femoral artery clamps | Profunda Arteria Femoralis Klemmen | Pinze per arteria femorale profunda | Pinzas para arteria femoral profunda | 大腿深動脈クランプ
- 131 **Dukklämmare** | Towel clamps | Tuchklemmen | Fissatele | Pinzas de campo | タオル鉗子
- 132 **Fattningstånger** | Intestinal grasping forceps | Darmfasszangen | Pinze per afferrare l'intestino | Pinzas para coger intestinos | 腸管把持鉗子
- 135 **Ringtänger** | Sponge holding forceps | Schwammzangen | Pinze per spugne | Pinzas para esponjas | スポンジ鉗子
- 137 **Klotånger** | Tenaculum forceps | Hakenzangen | Pinze per il collo dell'utero | Pinzas para coger el cuello del útero | 子宮支持鉗子スポンジ鉗子

140 **Hakar | Retractors | Wundhaken | Divaricatori | Separadores | 開創器、鉤、レトラクター**

- 142 **Hudhakar** | Skin hooks | Hauthäkchen | Uncini cutanei | Ganchos para piel | スキンフック
- 144 **Nervhakar** | Nerve hooks | Nervhäkchen | Uncini per nervi | Ganchos para nervios | 神経鉤
- 145 **Hakar** | Retractors | Wundhaken | Divaricatori | Separadores | 鉤(レトラクター)
- 151 **Bukhakar** | Abdominal retractors | Bauchdeckenhaken | Divaricatori addominali | Separadores abdominales | 開腹鉤
- 153 **Bukspatlar** | Abdominal spatulas | Bauchspatel | Spatole addominali | Espátulas abdominales | 腸ベラ
- 154 **Tracheotomihakar** | Trachea retractors | Trachealhaken | Divaricatori tracheali | Separadores para traquea | 気管支用レトラクター
- 155 **Självhållande hakar** | Self retaining retractors | Selbsthaltende Wundhaken | Autostatici divaricatori | Retención automática separadores | 開創器
- 157 **Revbensspridare** | Rib spreaders | Rippenspreizer | Divaricatori costali | Separadores costales | 開胸器
- 158 **Nässpekulum** | Nasal Specula | Nasenspekula | Speculi nasali | Espéculos nasales | 鼻鏡(スペキュラ)

160 **Slevar, Raspatorier, Elevatorier etc. | Curettes, Raspatories, Elevators etc. | Löffel, Raspatorien, Elevatorien etc. | Curette, Staccaperiostio, Elevatori etc. | Cucharillas, Legras, Elevadores etc. | 銳匙、やすり 骨膜起子**

- 162 **Uteruskyretter** | Uterine curettes | Uterusküretten | Curette uterine | Curetas uterinas | 子宮銳匙
- 163 **Slevar** | Bone curettes | Löffel | Curette | Cucharillas | 骨銳匙
- 164 **Raspatorier** | Raspatories | Raspatorien | Staccaperiostio | Legras | 骨膜剝離子
- 169 **Elevatorier** | Elevators | Elevatorien | Elevatori | Elevadores | 骨膜起子
- 173 **Dissektorer** | Dissectors | Dissektoren | Dissettori | Disecadores | 剝離子
- 174 **Raspar** | Rasps | Raspeln | Raspe | Escofinas | 骨やすり

176 Osteotomer, mejslar etc. | Osteotomes, Chisels etc. | Osteotome, Flachmeissel etc. | Osteotomi, Scalpelli etc. | Escoplos, Cinceles etc. | 両刃のみ 片刃のみ

178 Osteotomer | Osteotomes | Osteotome | Osteotomi | Escoplos | 両刃のみ

185 Mejslar | Chisels | Flachmeissel | Scalpelli | Cinceles | 片刃のみ

186 Gougemejlar | Gouges | Gouges | Sgorbie | Gubias | 丸刃のみ

187 Prylar | Awls | Pfrieme | Lesine | Escariadores | 穿孔器

188 Hammare | Mallets | Hämmer | Martelli | Martillos | 槌

190 Mikroinstrument | Micro instruments | Mikro-instrumente | Strumenti per microchirurgia | Instrumentos para microcirugia | マイクロ器具

194 Mikrosaxar | Micro scissors | Mikroscheren | Mikro forbici | Micro tijeras | マイクロ剪刀

196 Mikropincetter | Micro forceps | Mikropinzetten | Micro pinze | Micro pinzas | マイクロ鑷子

200 Mikronålförare | Micro needle holders | Mikronadelhalter | Micro portaghi | Micro porta-agujas | マイクロ持針器

204 Övriga instrument | Various instruments | Sonstige Instrumente | Altri strumenti | Instrumentos varios | 様々な器具

206 Övriga instrument | Various instruments | Sonstige Instrumente | Altri strumenti | Instrumentos varios | 様々な器具

215 Implantat & instrument | Implants & instruments | Implantate & Instrumente | Implantati & strumenti | Implantés & instrumentos | インプラントおよび器具

217 Register | Index | Verzeichnis | Indice | Índice | 索引

217 Numeriskt index | Numerical index | Nummernverzeichnis | Indice di numeri | Indice de números | 品番索

221 Alfabetiskt register | Alphabetical index | Alphabetisches Inhaltsverzeichnis | Indice alfabetico | Índice alfabético | アルファベット索引

Garanti

Med avseende på utförande och material lämnar vi garanti på kirurgiska handinstrument av egen tillverkning. I en period av 30 år efter inköp, ersätter eller reparerar vi kostnadsfritt ett skadat instrument om skadan finnes orsakad av fel i utförande eller material. Normal förslitning omfattas inte av vår garanti. Utfästelsen gäller under förutsättning att instrumentet används för avsett ändamål samt vårdas och lagras korrekt och att skriftlig anmälan görs till STILLE inom 30 dagar från skadetillfället.

Guarantee

Surgical hand instruments manufactured by STILLE carry a guarantee in respect of materials and workmanship. For a period of 30 years after purchase, we will replace or repair a damaged instrument free of charge if the damage is found to have been caused by a defect in materials or workmanship. The guarantee is conditional on the instrument being used for the purpose intended, is cared for and stored correctly and that any claims are made in writing within 30 days of the damage occurring.



Historien

När Sverige med Serafimerlasarettet fick sitt första undervisningssjukhus 1752 tog den medicinska vården ett stort steg framåt. Men hundra år senare fanns det fortfarande inte fler än 200 kirurger i hela landet. Med inrättandet av Karolinska institutet 1810 förenades de två grenarna medicin och kirurgi och studenter utbildades nu i både invärtes och utvärtes sjukdomar. Dessutom anställde Karolinska institutet en instrumentmakare som utöver tillverkning även gav utbildning i instrumentvård.

Det var den verksamheten på Karolinska institutet som Albert Stille tog över 1841 när han startade sitt företag. Redan från början förde han en intensiv dialog med läkare och kirurger. Ofta vände de sig direkt till honom och hans medarbetare med förslag och instrumentmakarna var alltid lika ivriga att förverkliga deras idéer. Den här nära relationen mellan ett medicintekniskt företag och olika medicinska institutioner var avgörande för den snabba utvecklingen inom medicin och kirurgi under 1800-talet.

De nyvunna kunskaperna inom mikrobiologi ledde till att man började sterilisera instrument, vilket minskade smittorisken för såväl patienter som kirurger och operationsassistenter. Och med viktiga upptäckter inom anestesi och antiseptisk sårbehandling vågade sig kirurgerna på allt djärvare ingrepp. Med hjälp av förfinade instrument skaffade de sig snabbt nya viktiga erfarenheter.

STILLE var först i världen med den tvådelade bentången redan 1872. Även andra produkter som revbenstången och gipssaxen gick hela tiden hand i hand med den snabba utvecklingen. Den nickelpläterade förlossningstången kom 1877. Ytan stod emot påverkan från blod och var lättare att rengöra. Förnicklade instrument blev därefter standard på marknaden tills STILLE 1923 introducerade världens första instrument i rostfritt stål. Och med SuperCut 1982 skapades en unik kvalitets sax som fortfarande söker sin like i världen.

Albert Stille valdes 1868 in som ledamot av Svenska läkaresällskapet. *"För hans förtjänster om den kirurgiska och obstetriska instrumenttillverkningen i vårt land och de flera lyckliga dels egna uppfinningar, dels förbättringar av förutvarande modeller"*. Så löd rekommendationen från professorer och kirurger vid Serafimerlasarettet och Karolinska institutet. Nio år senare valdes även sonen Max in som ledamot.

Albert och Max Stille delade en äkta, livslång passion för att utveckla kvalitetsinstrument. Mer än 175 år senare lever deras fasta övertygelse, starka framåtanda och förtroagna samarbete med läkare och kirurger fortfarande kvar hos STILLE.



Karolinska institutet och Serafimerlasarettet på 1860-talet.
Karolinska Institute and Serafimer Hospital in the 1860's.

History

When the Serafimer Hospital in Stockholm became Sweden's first teaching hospital in 1752, medical care in the country took a great step forward. But one hundred years later there were still no more than 200 practicing surgeons in the country. With the establishment of the Karolinska Institute in 1810, the two branches, medicine and surgery, were united and students were educated in both internal and external diseases. In addition, the Karolinska Institute commissioned an instrument maker that went beyond manufacturing but also provided training regarding instrument care.

It was this business at the Karolinska Institute that Albert Stille took over in 1841 when he started his company. From the outset, he maintained an intensive dialogue with physicians and surgeons. Often, they turned directly to him and his colleagues with suggestions, and the instrument makers were always eager to realize their ideas. This close relationship between a medical device company and various medical institutions was crucial to the rapid developments that occurred in medicine and surgery in the 1800's.

The newly gained knowledge in microbiology led to sterilization of instruments, which reduced the risk of infection for patients, surgeons and surgical assistants. And with important discoveries in anesthetics and antiseptic wound treatment, surgeons dared to undertake increasingly bold surgical procedures. With the help of sophisticated new instruments, surgeons rapidly acquired important new experience.

STILLE was the first in the world with the double-action bone rongeur as early as 1872. Other instruments like rib forceps and plaster scissors also contributed to the rapid development. The nickel-plated obstetrical forceps came in 1877. The surface was blood resistant and was easier to clean. Nickel-plated instruments became the market standard until 1923 when STILLE introduced the world's first stainless steel instruments. And

with the SuperCut in 1982, STILLE created a unique quality scissors that are still unmatched in the world.

In 1868 Albert Stille was elected as a member of the Swedish Society of Medicine. *"For his merits in the area of surgical and obstetrical instrument manufacturing in our country, and the success of their own inventions, and improvements to previous designs."* Those were the words at his induction from professors and surgeons at the Serafimer Hospital and the Karolinska Institute. Nine years later, his son Max was also voted in as a member.

Albert and Max Stille shared a genuine, lifelong passion for developing quality instruments. More than 175 years later, their firm convictions, strong ambitions and earnest collaboration with physicians and surgeons still live on with STILLE.



*Instrument för arméns sjukvård 1864.
Instruments for the Army Medical Corps 1864.*

Hantverk och service

Järnsmede med manufaktur av knivar, saxar, tänger och hammare har länge varit hjärtat i Eskilstunas industrihistoriska arv. STILLE är det enda medicintekniska företag i världen som fortfarande tillverkar instrument från rundstål i egen smedja. Än idag kan man höra hur hejarhammare slår ut det uppvärmda stålämnet, rikthammarnas lätta slag mot skänklar och käftar och filarnas torra raspande mot det ohärdade stålet.

För instrumentmakarna har tillverkningen alltid behållit sin hantverksmässiga karaktär. Här förlitar man sig inte enbart på ritningar utan precis lika mycket på den egna känslan för funktion och egenskaper. Ett färdigt instrument fungerar som modell. Måtten sitter redan i nävarna. Instrumentmakarna känner den exakta böjningen med fingrarna och vet hur ett perfekt instrument känns i handen. Minsta defekt märks direkt.

Den där speciella fingertoppskänslan för funktion och egenskaper delar instrumentmakaren med kirurgen. Genom åren har STILLE samarbetat med en lång rad välkända kirurger över hela världen. De har på olika sätt

medverkat vid konstruktion och vidareutveckling. Deras erfarenhet och uppfinningsrikedom har ytterligare förfinat instrumenten. Därför kan en lång rad välkända kirurgers namn läggas till STILLES eget i sortimentet.

Instrumentmakarens sista arbetsmoment är att sätta firmamärket på det färdiga instrumentet. Under mer än 175 år har det kommit att stå för ett gediget hantverk, suverän funktion och överlägsen kvalitet. Det har gjort STILLE till ett osvikligt kännetecken för de unika instrumentegenskaper som kirurger världen över efterfrågar.

Alla instrument som regelbundet servas av STILLES skickliga instrumentmakare omfattas av en exklusiv 30-årsgaranti. Under servicen plockas instrumenten isär och rengörs in i minsta detalj, rörliga delar justeras och smörjs, saxblad slipas, eggar vässas, ytor renoveras och putsas innan instrumenten till slut funktionstestas. Den här noggranna omsorgen förlänger instrumentets livslängd och ökar patientsäkerheten.



Craftsmanship and Service

Iron working and the manufacture of knives, scissors, pliers and hammers have long been at the heart of the city of Eskilstuna's industrial heritage. STILLE is the only medical instrument maker in the world that still manufactures instruments from tubular steel in their own forge. Even today, one can hear the beat as the drop hammer flattens the heated steel slabs, the light blow of chasing hammers to the shanks and jaws, and the dry rasping of files against the unhardened steel.

For makers of precision surgical instruments, production has always maintained its artisanal character. They rely not only on drawings but, just as much, on their own sense of functionality and feature. A complete instrument works like a model. The dimensions are already in the hands. Instrument makers know the precise bend with their own fingers, and they know how a perfect instrument should feel in the human hand. Minimum defects are immediately evident.

Instrument makers share that special fingertip sense of functionality with the surgeon. Through the years, STILLE has collaborated with a long list of renowned surgeons the world over. They have contributed in various ways to the construction and further development. Their experience and ingenuity has helped to further refine surgical instruments. Therefore, many wellknown surgeons' names have been added to STILLE's wide range of instruments.

An instrument maker's final task is to put the company name on the finished instrument. For more than 175 years, it has come to stand for solid craftsmanship, superb performance and superior quality. This has made the STILLE name synonymous with the unique features and performance that surgeon's around the world demand.

All instruments that are regularly serviced by STILLE's skilled technicians are covered by an exclusive 30-year warranty. During the service process the instruments are disassembled and cleaned thoroughly, moving parts are adjusted and lubricated, scissor blades are sharpened, edges are honed, surfaces refinished and cleaned before the instruments undergo comprehensive testing. This meticulous maintenance prolongs the life of the instrument and increases patient safety.



“SCISSORS, PLEASE!” Kirurger över hela världen föredrar STILLES saxar. De är lätta och välbalanserade med en jämn, mjuk känsla som följer minsta rörelse så att saxen blir en naturlig förlängning av handen. Saxens utformning ger ett fast grepp med maximal klippförmåga för alla typer av mjuk vävnad. Oavsett modell är precisionen perfekt, hela vägen ut i spetsarna.

Sedan STILLE uppfann den första SuperCut-saxen redan 1982 har många försökt sig på att kopiera den. Men efter tre decennier kan fortfarande inget annat fabrikat mäta sig med denna handtillverkade supersax. En av de främsta egenskaperna är de specialdesignade skärytorna. Med ett saxslipat och ett knivslipat blad skär sig saxen mjukt och effektivt genom vävnaden. Snittet blir perfekt. Varje gång.

Saxsortimentet har utökats med ergonomiska saxar med vinklade skänklar för ett bekvämare grepp. Precis som alla andra saxar från STILLE är de högglanspolerade och kan vid service tas isär för enklare rengöring och sterilisering. Det ökar säkerheten för patient och kirurg samt förlänger instrumentets livstid. All service sköts av våra egna skickliga instrumentmakare. En sax från STILLE behåller sin höga kvalitet år efter år.



“SCISSORS, PLEASE!” Surgeons worldwide prefer scissors from STILLE. They are light and well-balanced with a smooth, soft feel that follows every movement so that the scissors become a natural extension of the hand. The scissor’s design provides a firm grip with maximum cutting power for all types of soft tissue. Regardless of the model they are perfectly precise – all the way to the tip.

Since STILLE invented the first SuperCut-scissors back in 1982, many have attempted to imitate the design. But after three decades no other brand can measure up to the handmade craftsmanship of the SuperCut. One of the main features is the specially designed cutting surfaces. With one scissor blade and one knife blade the scissors cut smoothly and efficiently through soft tissue. A perfect cut. Every time!

The product line has been expanded to include ergonomic scissors that feature angled handles for a more comfortable grip. Like all scissors from STILLE they are highly polished and can be disassembled for easy maintenance, cleaning and sterilization. This increases safety for the patient and the surgeon and extends the instrument’s effective lifetime. All service is handled by our own skilled craftsmen. A pair of scissors from STILLE retains their high quality year after year.

Saxar | Scissors | Scheren | Forbici | Tijeras | 剪刀 (はさみ)

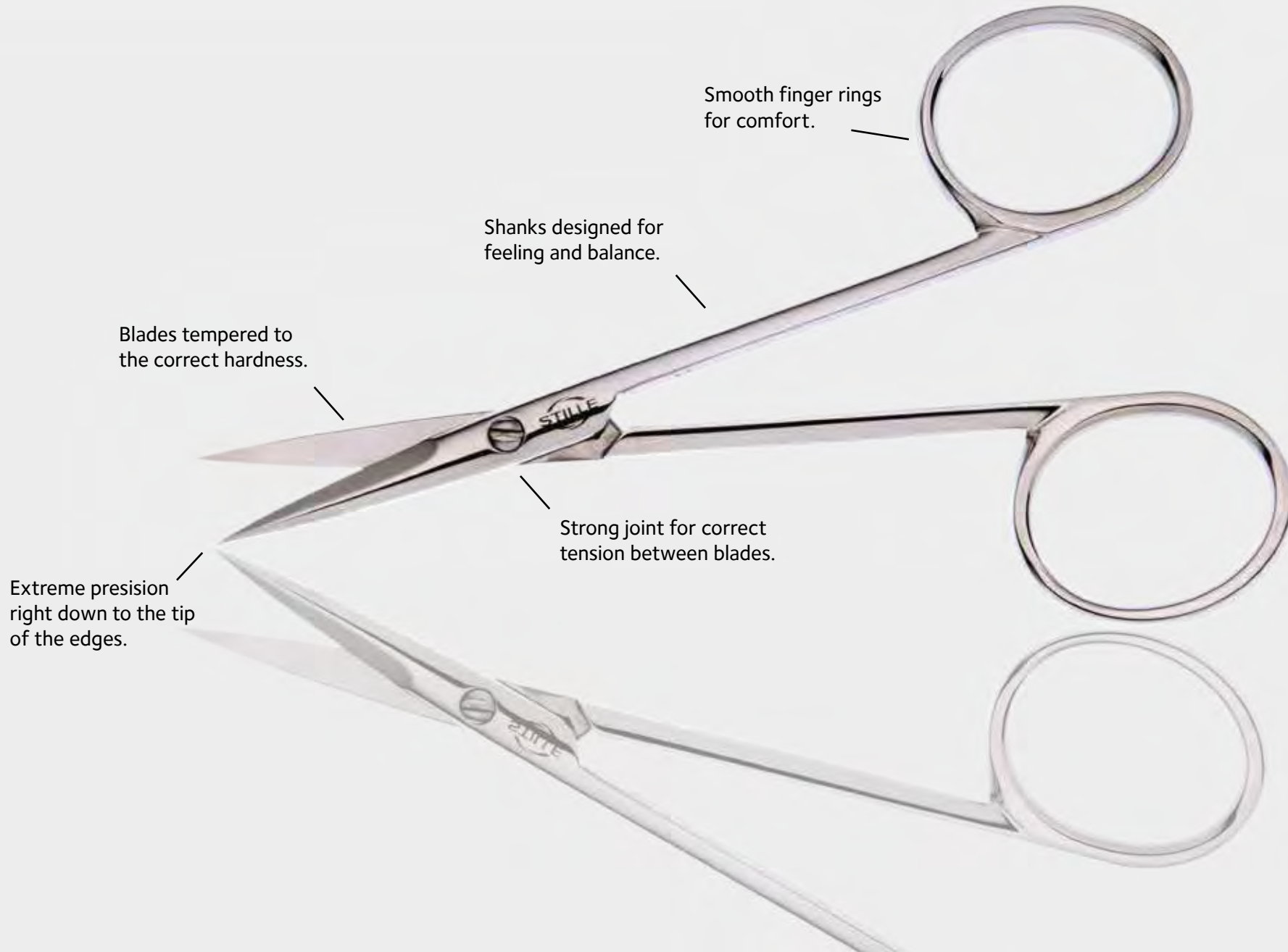



STILLE Ögonsax | STILLE Eye Scissors

ORIGINAL

Saxar har alltid tillhört STILLES storsäljare alltsedan de började tillverkas på 1800-talet. Genom åren har de ständigt förbättrats och fler specialmodeller har tillkommit. Idag finns de i totalt ca 200 varianter i alla storlekar och utformningar.

Originalsaxarna tillverkas i rostfritt stål av högsta kvalitet med högglanspolerad yta. De är välbalanserade med god skärstyrka ända ut i spetsarna och ligger bra i handen. Det finns originalsaxar för alla typer av mjukvävnad och de kan även användas för att klippa gasbinda, tråd och suturer.

SUPERCUT

Saxarnas sax uppfanns 1982. Många kirurger anser att SuperCut är världens absolut bästa kirurgisax. Den passar alla typer av mjuk vävnad och precisionen och prestandan är välkänd bland kirurger över hela världen.

Det revolutionerande med SuperCut är skärytorna som samarbetar på ett unikt sätt. Det ena bladet är saxslipat och det andra är knivslipat så att saxen skär sig fram genom vävnaden. Det ger maximal skärstyrka med minimal kraft och ett perfekt snitt. Slipningen gör saxen lämplig för både höger- och vänsterhänta. Trots många år på marknaden har ingen lyckats skapa en kopia som kan överträffa originalet.

STILLES nya beläggning på SuperCut görs med ett mycket tunt diamantliknande skikt av s.k. DLC-coating, som reducerar risken för missfärgning, ökar instrumentets hållbarhet och bidrar till en bättre miljö.

ORIGINAL

Scissors have always been STILLE's bestseller ever since they were first produced in the 1800's. Through the years they have been continually improved and more special models have been introduced. Currently, there are in total about 200 different varieties in all sizes and shapes.

Our original scissors are manufactured of the highest quality, polished stainless steel. They are well balanced with outstanding cutting power right down to the tips and they fit well in the surgeon's hand. There are original scissors for all types of soft tissue and they can also be used to cut gauze, wire and sutures.

SUPERCUT

These unique scissors were introduced in 1982. Many surgeons believe that the SuperCut are unsurpassed as the world's best surgical scissors. They are suitable for all types of soft tissue and the precision and performance are well known among surgeons worldwide.

The revolutionary SuperCut scissors feature cutting surfaces that work together in a unique way. One blade is a scissor blade and the other is a knife blade to enable the scissors to cut precisely through the soft tissue. They provide maximum cutting power with minimal force and produce a perfect cut. The sharpening makes the scissors suitable for both right and left handed users. Despite many years on the market, other brands have not been able to create an imitation that can surpass the original SuperCut scissors.

The new STILLE coating process is based on a thin layer diamond-like-carbon proprietary technology, aiming to reduce discoloration, improve instrument durability and help to create a more sustainable environment.



STILLE-Mayo SuperCut XE dissektionsax |
STILLE-Mayo SuperCut XE Dissecting Scissors

DIAMOND SUPERCUT

Våra nya STILLE Diamond SuperCut saxar tar kirurgiska saxar till en ny nivå. Vi välkomnar er att uppleva dissektion, klippegenskaper och hållbarhet som ni aldrig tidigare upplevt. Diamond SuperCut är handgjorda av våra skickliga instrumentmakare i Eskilstuna. Saxarna är helbelagda med en ny diamantliknande beläggning, som ökar hållbarheten, minskar behovet av återkommande slipning, är mer motståndskraftig mot korrosion och är mer miljövänlig. Den nya Diamond-beläggningen är validerad för att tåla de allt vanligare rengöringsprocesserna med väteperoxid.



Metzenbaum STILLE Diamond SuperCut dissektionssax
| Metzenbaum STILLE Diamond SuperCut Dissecting Scissors

ERGONOMISKA SAXAR

En naturlig fortsättning på arbetet med att skapa perfekta saxar har varit att vidareutveckla deras ergonomiska egenskaper. Kirurgiska saxar hålls normalt i ett precisionsgrepp med tummen och lång- eller ringfingret. Vid mer tidskrävande ingrepp tröttnas handen ut snabbare.

Lösningen är att vinkla skänklarna så att handen kan arbeta närmare sitt normala viloläge. Med ett större mellanrum mellan fingeröglorna motverkas spänningar och trötthet och handen orkar arbeta längre. Samtliga ergonomiska saxar är av modellen SuperCut med sina unika egenskaper. Sax- och knivslipade blad samverkar för maximal skärstyrka med minimal kraft och exakt precision.

DIAMOND SUPERCUT

The new STILLE Diamond SuperCut redefines the industry standards and breaks the limits in instrument performance. We welcome you to experience dissection, cutting performance and durability like you've never felt before. The Diamond SuperCut series of scissors are hand-made to perfection in Sweden. The scissors are fully coated with a new proprietary diamond-like-layer. It not only increases the life expectancy, it reduces the need of sharpening, is more resistant to corrosion and it's more environmental friendly. The new Diamond coating is validated to withstand the more common hydro peroxide processes.

ERGONOMIC SCISSORS

A natural extension of the ongoing effort to create the perfect scissors has been the further development of their ergonomic properties. Surgical scissors are normally held in a precise grip using the thumb and middle or ring finger. For more time-consuming procedures this can cause the hand to become fatigued faster.

The solution is to angle the shanks so that the hand can work closer to its normal resting position. With a larger gap between the finger loops, tension and fatigue is countered and the hand can work more comfortably for a longer period. All ergonomic scissors are SuperCut models with their unique characteristics. Scissor and knife sharpened blades work together for maximum cutting power with minimal effort and exact precision.

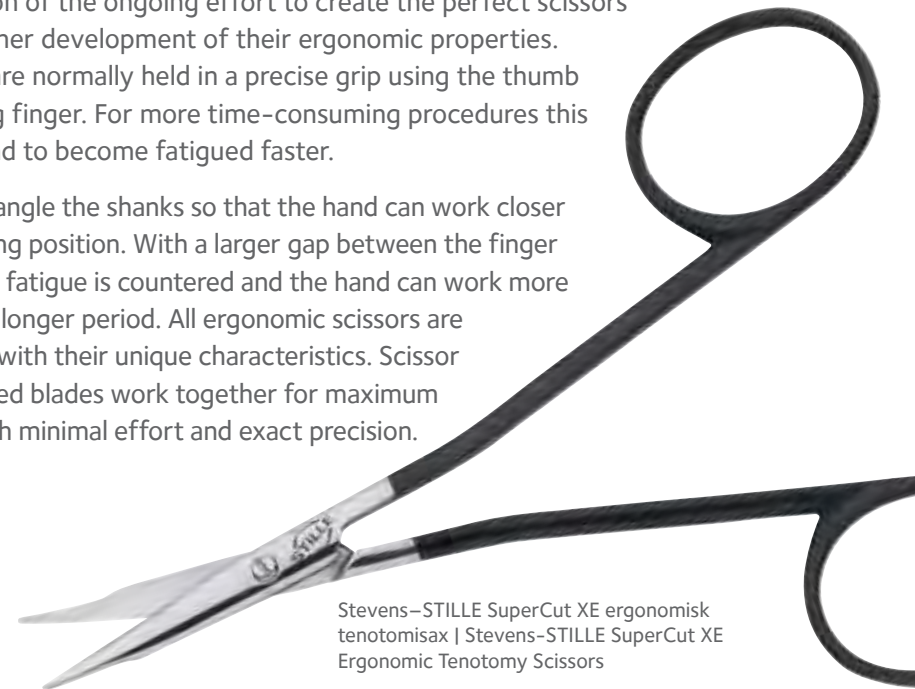

Stevens-STILLE SuperCut XE ergonomisk
tenotomisax | Stevens-STILLE SuperCut XE
Ergonomic Tenotomy Scissors

STILLE ögonsax | STILLE Eye Scissors

Delicate eye scissors with sharp or blunt tips and large finger rings. These are also called iris scissors and are used for nerves, tendons and vessels. They are intended for facial surgery and any type of delicate surgery. Beveled blades.

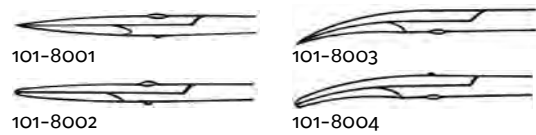
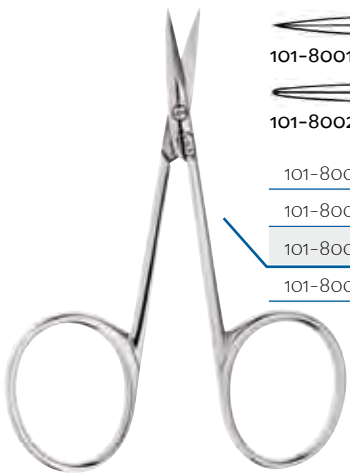

101-8001	Straight	Sharp	9.5 cm 3.75"
101-8002	Straight	Blunt	9.5 cm 3.75"
101-8003	Curved	Sharp	9.5 cm 3.75"
101-8004	Curved	Blunt	9.5 cm 3.75"

STILLE ögonsax | STILLE Eye Scissors

Eye scissors for delicate work. Large finger rings for a comfortable grip. Beveled blades.

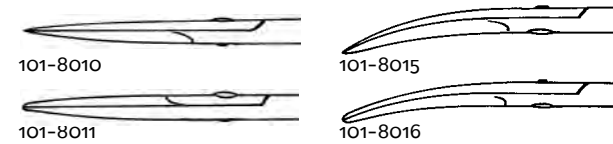
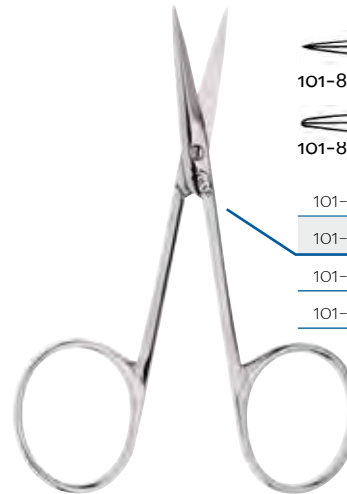

101-8010	Straight	Sharp	10 cm 4"
101-8011	Straight	Blunt	10 cm 4"
101-8015	Curved	Sharp	10 cm 4"
101-8016	Curved	Blunt	10 cm 4"

STILLE SuperCut XE ögonsax | STILLE SuperCut XE Eye Scissors

SuperCut XE eye scissors with sharp or blunt tips and extremely sharp edges. Beveled blades.

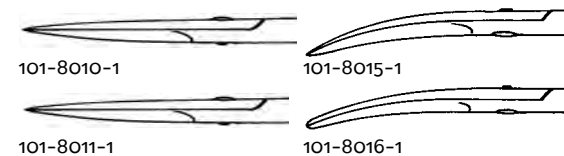

101-8010-1	Straight	Sharp	10 cm 4"
101-8011-1	Straight	Blunt	10 cm 4"
101-8015-1	Curved	Sharp	10 cm 4"
101-8016-1	Curved	Blunt	10 cm 4"

STILLE SuperCut XE ögonlockssax | STILLE SuperCut XE Blepharoplasty Scissors

Short delicate SuperCut XE scissors suitable for blepharoplasty.

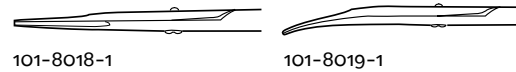

101-8018-1	Straight	9,5 cm 3.75"
101-8019-1	Curved	9,5 cm 3.75"

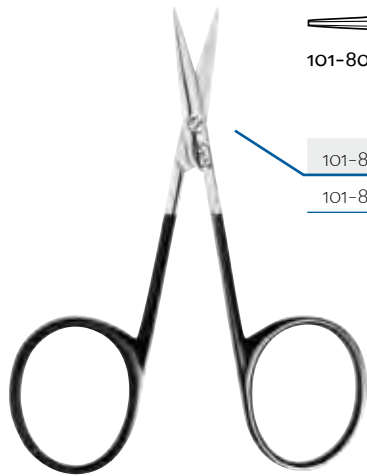

STILLE SuperCut XE ergonomisk ögonlockssax | STILLE SuperCut XE Ergonomic Blepharoplasty Scissors

Blepharoplasty SuperCut XE scissors with ergonomically designed shanks for a more relaxed grip.

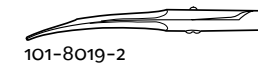

101-8019-2	Curved	9,5 cm 3.75"
------------	--------	--------------

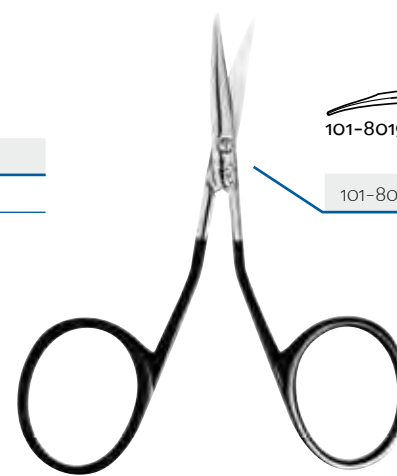

Ragnell STILLE SuperCut XE ögonlockssax | Ragnell STILLE SuperCut XE Blepharoplasty Scissors

Short delicate SuperCut XE scissors with blunt, flat tips for blepharoplasty.

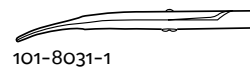

101-8031-1	Curved	9,5 cm 3.75"
------------	--------	--------------

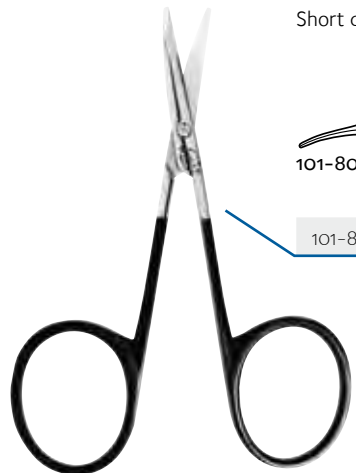

Ragnell STILLE SuperCut XE ergonomisk ögonlockssax | Ragnell STILLE SuperCut XE Ergonomic Blepharoplasty Scissors

Blepharoplasty SuperCut XE scissors with ergonomically designed shanks for a more relaxed grip.



101-8031-2	Curved	9,5 cm 3.75"
------------	--------	--------------

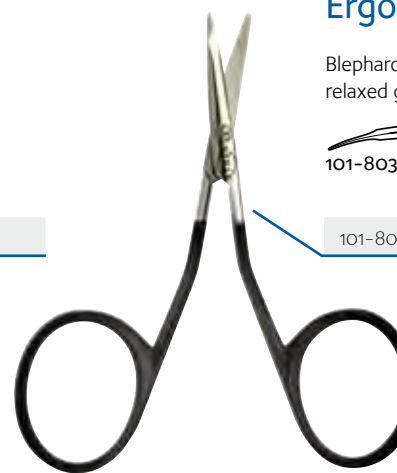

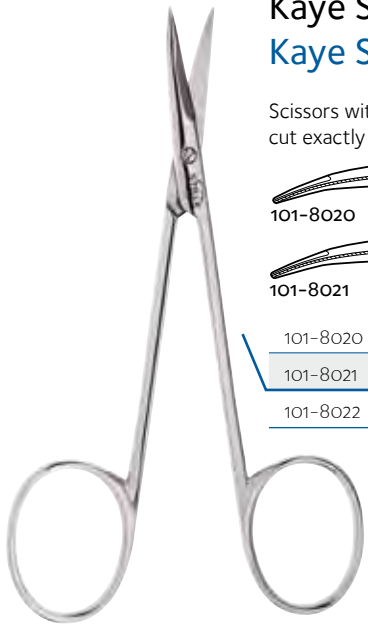

Kaye STILLE dissektionssax |
Kaye STILLE Dissecting Scissors

Scissors with serrated blades for "holding" the tissue, making it easier to cut exactly as far as intended.

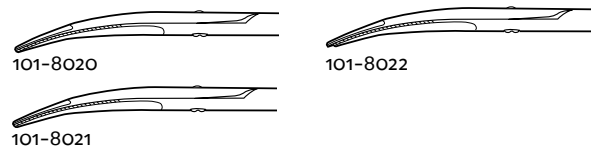

101-8020	Blunt serrated	Curved	10 cm 4"
101-8021	Blunt serrated	Curved	12.5 cm 5"
101-8022	Sharp serrated	Curved	12.5 cm 5"

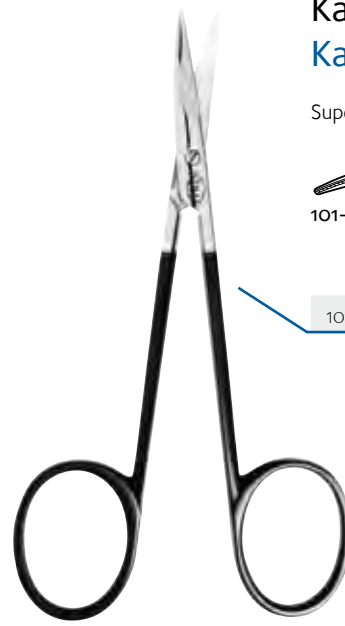

Kaye STILLE SuperCut XE dissektionssax |
Kaye STILLE SuperCut XE Dissecting Scissors

SuperCut XE version for improved cutting performance.

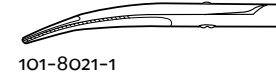

101-8021-1	Blunt serrated	Curved	12.5 cm 5"
------------	----------------	--------	------------



Jabaley STILLE dissektionssax |
Jabaley STILLE Dissecting Scissors

Sharp scissors suitable for hand surgery, where very strong scissors are used. Beveled blades.



101-8060	Straight	12.5 cm 5"
101-8062	Curved	12.5 cm 5"

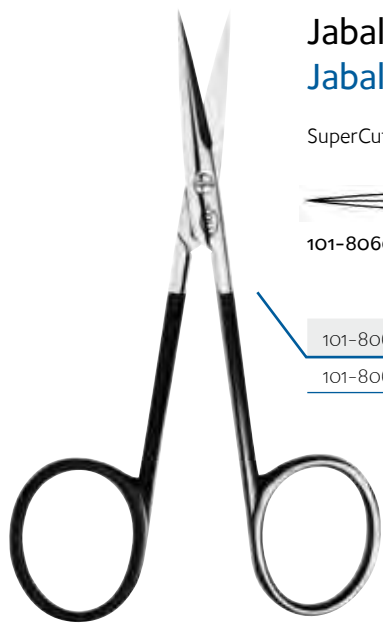

Jabaley STILLE SuperCut XE dissektionssax | Jabaley STILLE SuperCut XE Dissecting Scissors

SuperCut XE scissors for dissection of tough tissue in hand surgery. Beveled blades.

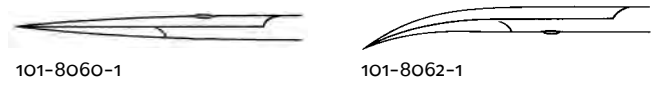

101-8060-1	Straight	12.5 cm 5"
101-8062-1	Curved	12.5 cm 5"

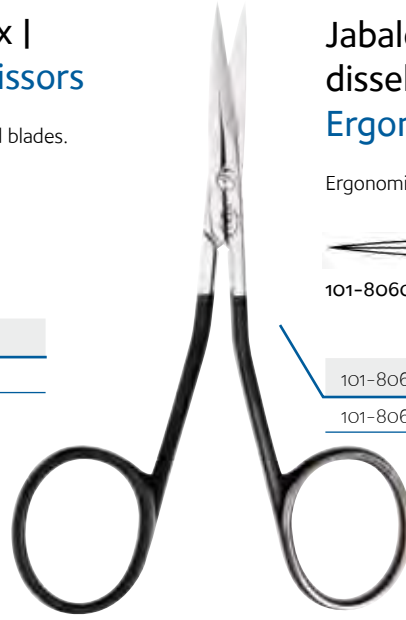

Jabaley STILLE SuperCut XE ergonomisk dissektionssax | Jabaley STILLE SuperCut XE Ergonomic Dissecting Scissors

Ergonomic model to avoid fatigue in the hand. Beveled blades.

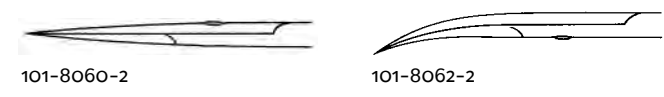

101-8060-2	Straight	12.5 cm 5"
101-8062-2	Curved	12.5 cm 5"



Mayo STILLE dissektionssax | Mayo STILLE Dissecting Scissors

The most used scissors, for all types of surgery. Used for routine dissection and cutting in tissue. Beveled blades.

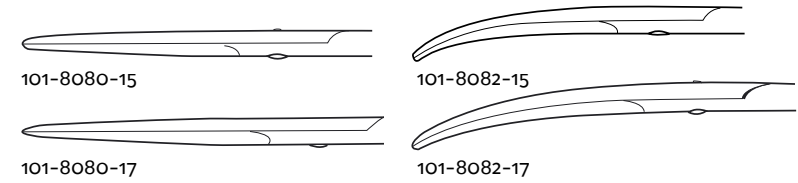

101-8080-15	Straight	15 cm 6"
101-8080-17	Straight	17 cm 6.75"
101-8082-15	Curved	15 cm 6"
101-8082-17	Curved	17 cm 6.75"

Mayo STILLE SuperCut XE dissektionssax | Mayo STILLE SuperCut XE Dissecting Scissors

SuperCut XE dissecting scissors for tough tissue. Beveled blades.

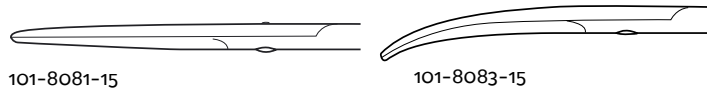

101-8081-15	Straight	15 cm 6"
101-8083-15	Curved	15 cm 6"

STILLE-Mayo dissektionssax | STILLE-Mayo Dissecting Scissors

Sturdy dissecting scissors with rounded blades.

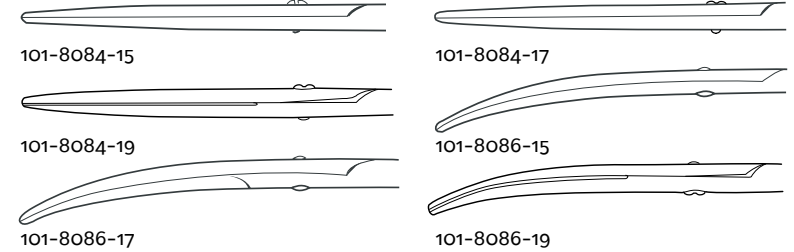
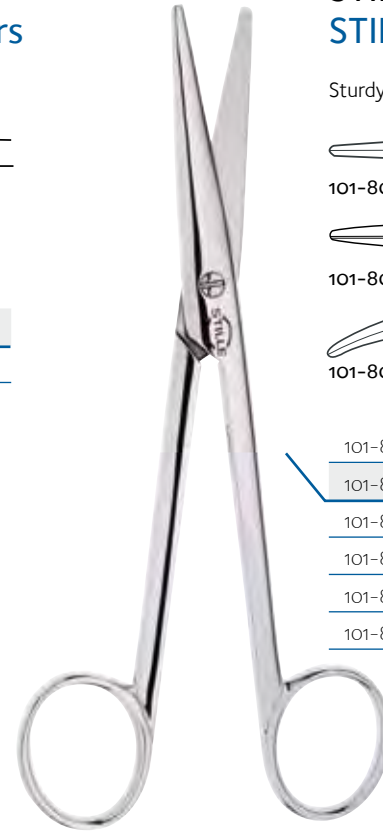

101-8084-15	Rounded blades	Straight	15 cm 6"
101-8084-17	Rounded blades	Straight	17 cm 6.75"
101-8084-19	Rounded blades	Straight	19 cm 7.5"
101-8086-15	Rounded blades	Curved	15 cm 6"
101-8086-17	Rounded blades	Curved	17 cm 6.75"
101-8086-19	Rounded blades	Curved	19 cm 7.5"

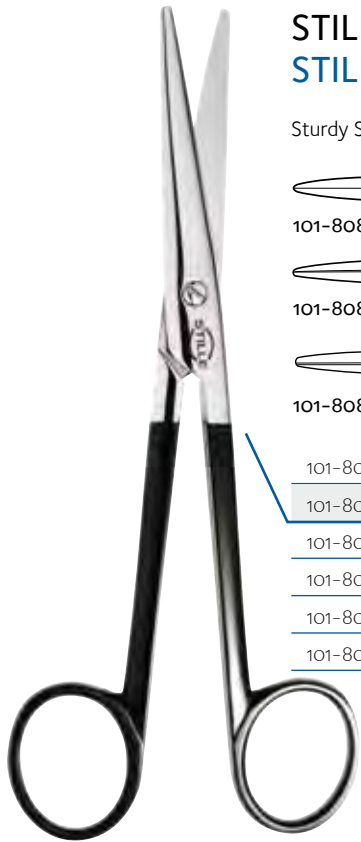

STILLE-Mayo SuperCut XE dissektionssax | STILLE-Mayo SuperCut XE Dissecting Scissors

Sturdy Super Cut scissors with rounded blades for dissection of tough tissue.

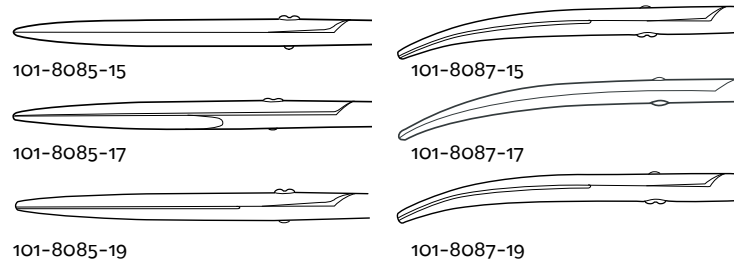

101-8085-15	Rounded blades	Straight	15 cm 6"
101-8085-17	Rounded blades	Straight	17 cm 6.75"
101-8085-19	Rounded blades	Straight	19 cm 7.5"
101-8087-15	Rounded blades	Curved	15 cm 6"
101-8087-17	Rounded blades	Curved	17 cm 6.75"
101-8087-19	Rounded blades	Curved	19 cm 7.5"

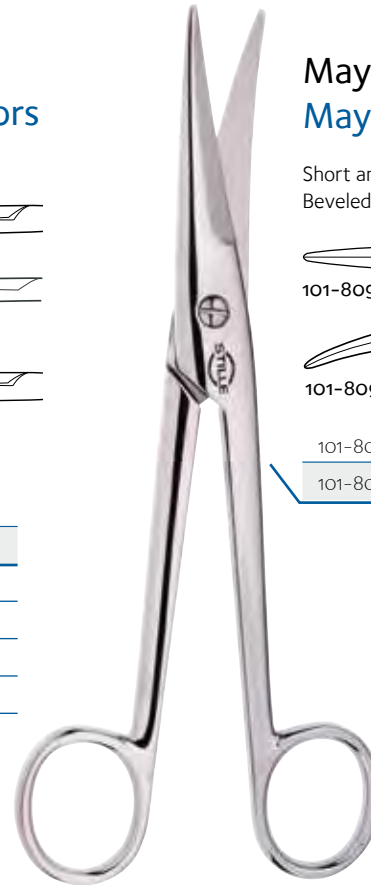

Mayo-Noble STILLE dissektionssax | Mayo-Noble STILLE Dissecting Scissors

Short and strong dissecting scissors mainly for orthopaedic surgeons. Beveled blades.

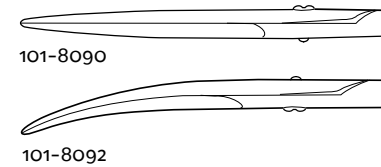

101-8090	Straight	18 cm 7"
101-8092	Curved	18 cm 7"

Baby Mayo STILLE dissektionssax | Baby Mayo STILLE Dissecting Scissors

Delicate version of the regular Mayo scissors. Mainly for plastic- and hand surgery. Beveled blades.

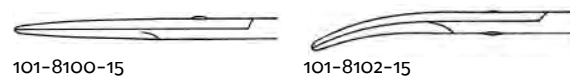

101-8100-15	Straight	15 cm 6"
101-8102-15	Curved	15 cm 6"





**Sims STILLE dissektionssax |
Sims STILLE Dissecting Scissors**

Mainly used in gynecological and other pelvic surgery. Beveled blades.



101-8138

101-8138	Curved	20 cm 8"
----------	--------	----------

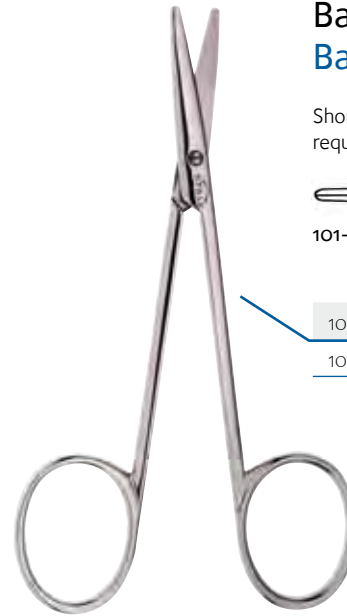

**Baby Metzenbaum STILLE dissektionssax |
Baby Metzenbaum STILLE Dissecting Scissors**

Short, delicate dissecting scissors with rounded blades. Used in delicate surgery requiring small instruments.



101-8160



101-8162

101-8160	Straight	12.5 cm 5"
101-8162	Curved	12.5 cm 5"

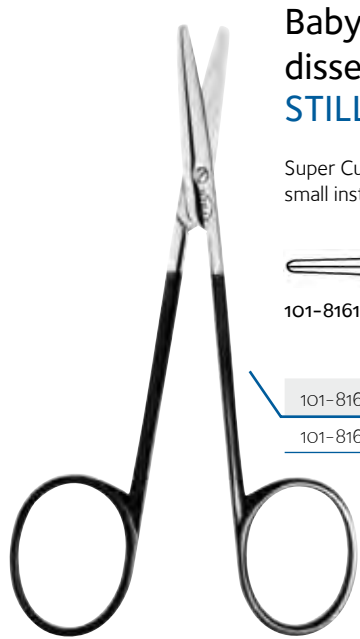

Baby Metzenbaum STILLE SuperCut XE dissektionssax | **Baby Metzenbaum STILLE SuperCut XE Dissecting Scissors**

Super Cut dissecting scissors for tough tissue. Used in delicate surgery requiring small instruments.



101-8161



101-8163

101-8161	Straight	12.5 cm 5"
101-8163	Curved	12.5 cm 5"



Baby Metzenbaum STILLE Diamond SuperCut dissektionssax | **Baby Metzenbaum STILLE Diamond SuperCut Dissecting Scissors**

With Diamond coating for increased durability.



101-8163-C

101-8163-C	Curved	12.5 cm 5"
------------	--------	------------



Baby Metzenbaum STILLE SuperCut XE ergonomisk dissektionssax | **Baby Metzenbaum STILLE SuperCut XE Ergonomic Dissecting Scissors**

Ergonomic model for better control. Rounded blades.



101-8163-2

101-8163-2	Curved	12.5 cm 5"
------------	--------	------------

Metzenbaum STILLE gracil dissektionssax | Metzenbaum STILLE Delicate Dissecting Scissors

Short, delicate dissecting scissors with rounded blades. Used in delicate surgery requiring small instruments.



101-8172

101-8172-18 Curved delicate 18 cm 7"

101-8172-23 Curved delicate 23 cm 9"



Metzenbaum STILLE gracil SuperCut XE dissektionssax | Metzenbaum STILLE Delicate SuperCut XE Dissecting Scissors

Very delicate version with Super Cut edges and fine rounded tips.



101-8173-15

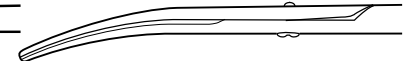

101-8173-18
101-8173-20

101-8173-15 Curved delicate

15 cm 6"

101-8173-18 Curved delicate

18 cm 7"

101-8173-20 Curved delicate

20 cm 8"



Metzenbaum STILLE gracil Diamond SuperCut dissektionssax | Metzenbaum STILLE Delicate Diamond SuperCut Dissecting Scissors

With Diamond coating for increased durability.

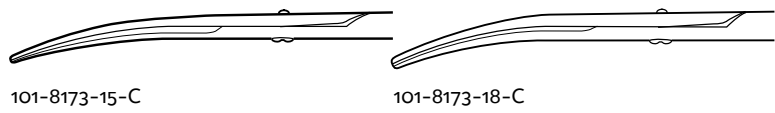

101-8173-15-C	Curved delicate	15 cm 6"
101-8173-18-C	Curved delicate	18 cm 7"



Metzenbaum STILLE dissektionssax | Metzenbaum STILLE Dissecting Scissors

Dissecting scissors with rounded blades and tips. Used in all specialties for fine dissection. Metzenbaum is one of STILLE's most popular scissors model and is available in a variety of shapes and sizes.

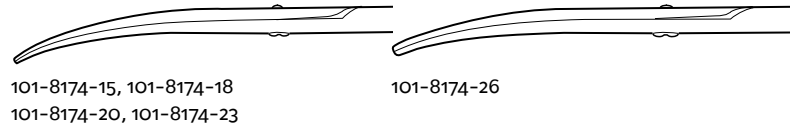

101-8174-15	Curved	15 cm 6"
101-8174-18	Curved	18 cm 7"
101-8174-20	Curved	20 cm 8"
101-8174-23	Curved	23 cm 9"
101-8174-26	Curved	26 cm 10.25"

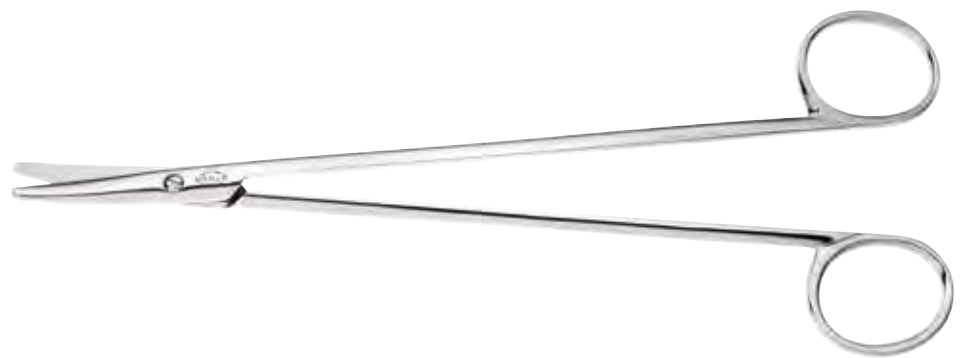

STILLE-Ekberg Metzenbaum gracil SuperCut ergonomisk dissektionssax | STILLE-Ekberg Metzenbaum Delicate SuperCut Ergonomic Dissecting Scissors

Ergonomic STILLE-Ekberg version. Available with blades curved up or down, suitable for both left- and right-handed surgeons.



101-8173-153D



101-8173-153U

101-8173-153D	Curved down	15 cm 6"
101-8173-153U	Curved up	15 cm 6"



STILLE-Ekberg Metzenbaum gracil Diamond SuperCut ergonomisk dissektionssax | STILLE-Ekberg Metzenbaum Delicate Diamond SuperCut Ergonomic Dissecting Scissors

Diamond version for increased durability.



101-8173-153D-C



101-8173-153U-C

101-8173-153D-C	Curved down	15 cm 6"
101-8173-153U-C	Curved up	15 cm 6"



Metzenbaum STILLE SuperCut XE dissektionssax | Metzenbaum STILLE SuperCut XE Dissecting Scissors

The popular Metzenbaum dissecting scissors with Super Cut edges. Rounded/beveled blades.

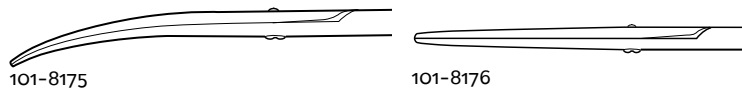

101-8175-15	Curved	15 cm 6"
101-8175-18	Curved	18 cm 7"
101-8175-20	Curved	20 cm 8"
101-8175-23	Curved	23 cm 9"
101-8175-26	Curved	26 cm 10.25"
101-8175-30	Curved	30 cm 12"
101-8175-33	Curved	33 cm 13"
101-8176-15	Straight	15 cm 6"
101-8176-18	Straight	18 cm 7"
101-8176-20	Straight	20 cm 8"
101-8176-23	Straight	23 cm 9"
101-8176-26	Straight	26 cm 10.25"



Metzenbaum STILLE Diamond SuperCut dissektionssax | Metzenbaum STILLE Diamond SuperCut Dissecting Scissors

Diamond version of the popular Metzenbaum STILLE SuperCut scissors, for increased durability.



101-8175-15-C	Curved	15 cm 6"
101-8175-18-C	Curved	18 cm 7"
101-8175-20-C	Curved	20 cm 8"
101-8175-23-C	Curved	23 cm 9"
101-8175-26-C	Curved	26 cm 10.25"
101-8175-30-C	Curved	30 cm 12"



Metzenbaum STILLE SuperCut XE ergonomisk dissektionssax | Metzenbaum STILLE SuperCut XE Ergonomic Dissecting Scissors

Metzenbaum Super Cut scissors with ergonomically designed shanks for a more comfortable grip. Rounded/beveled blades.



101-8175-152, 101-8175-182

101-8175-152	Curved	15 cm 6"
101-8175-182	Curved	18 cm 7"



STILLE-Ekberg Metzenbaum SuperCut ergonomisk dissektionssax | STILLE-Ekberg Metzenbaum SuperCut Ergonomic Dissecting Scissors

Ergonomic STILLE-Ekberg version. Available with blades curved up or down, suitable for both left- and right-handed surgeons.



101-8175-153D



101-8175-153U

101-8175-153D	Curved down	15 cm 6"
101-8175-153U	Curved up	15 cm 6"



STILLE-Ekberg Metzenbaum Diamond SuperCut ergonomisk dissektionssax | STILLE-Ekberg Diamond Metzenbaum SuperCut Ergonomic Dissecting Scissors

Diamond version for increased durability.

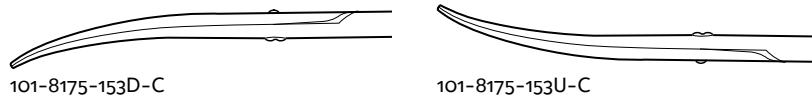

101-8175-153D-C Curved down 15 cm 6"

101-8175-153U-C Curved up 15 cm 6"



Ragnell STILLE dissektionssax | Ragnell STILLE Dissecting Scissors

Dissecting scissors with flat, rounded tips. Often used in plastic surgery. Is also called Killner by some manufacturers. The short models are used for undermining in plastic surgery and the long models are used for further dissection.

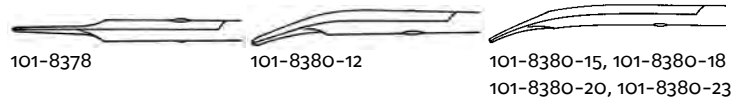

101-8378	Straight	12.5 cm 5"
101-8380-12	Curved	12.5 cm 5"
101-8380-15	Curved	15 cm 6"
101-8380-18	Curved	18 cm 7"
101-8380-20	Curved	20 cm 8"
101-8380-23	Curved	23 cm 9"



Ragnell STILLE SuperCut XE dissektionssax | Ragnell STILLE SuperCut XE Dissecting Scissors

Super Cut version of the Ragnell scissors. For precise undermining of flaps.

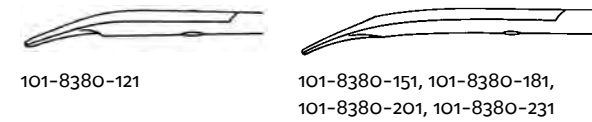

101-8380-121	Curved	12.5 cm 5"
101-8380-151	Curved	15 cm 6"
101-8380-181	Curved	18 cm 7"
101-8380-201	Curved	20 cm 8"
101-8380-231	Curved	23 cm 9"



Ragnell STILLE Diamond SuperCut dissektionssax | Ragnell STILLE Diamond SuperCut Dissecting Scissors

Diamond version of the Ragnell STILLE SuperCut scissors, for increased durability.



101-8380-121-C

101-8380-151-C
101-8380-181-C

101-8380-121-C	Curved	12.5 cm 5"
101-8380-151-C	Curved	15 cm 6"
101-8380-181-C	Curved	18 cm 7"



STILLE-Ekberg Ragnell SuperCut ergonomisk dissektionssax | STILLE-Ekberg Ragnell SuperCut Ergonomic Dissecting Scissors

Ergonomic STILLE-Ekberg version. Available with blades curved up or down, suitable for both left- and right-handed surgeons.

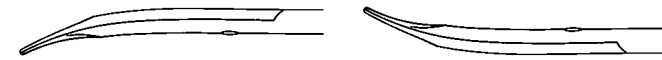

101-8380-153D

101-8380-153U

101-8380-153D	Curved down	15 cm 6"
101-8380-153U	Curved up	15 cm 6"



STILLE-Ekberg Ragnell Diamond SuperCut ergonomisk dissektionssax | STILLE-Ekberg Ragnell Diamond SuperCut Ergonomic Dissecting Scissors

Diamond version for increased durability.

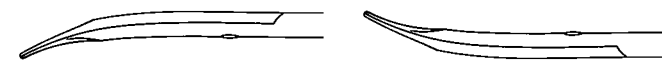

101-8380-153D-C

101-8380-153U-C

101-8380-153D-C	Curved down	15 cm 6"
101-8380-153U-C	Curved up	15 cm 6"

Ragnell STILLE SuperCut XE ergonomisk dissektionssax | Ragnell STILLE SuperCut XE Ergonomic Dissecting Scissors

Ergo Super Cut versions of Ragnell scissors for precise undermining of flaps and comfortable grip.

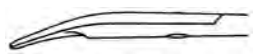

101-8380-122

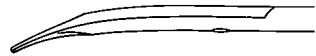

101-8380-152

101-8380-122	Curved	12,5 cm 5"
101-8380-152	Curved	15 cm 6"



Thorek STILLE dissektionssax | Thorek STILLE Dissecting Scissors

Strongly curved dissecting scissors for good visibility. Rounded blades.

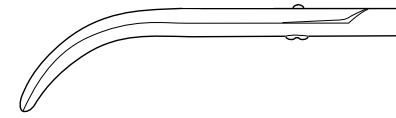

101-8470

101-8470	Strongly curved	21 cm 8.25"
----------	-----------------	-------------



STILLE Cooper operations sax | STILLE Cooper Operating Scissors

General purpose utility scissors, often used for sutures, gauze etc. Beveled blades.

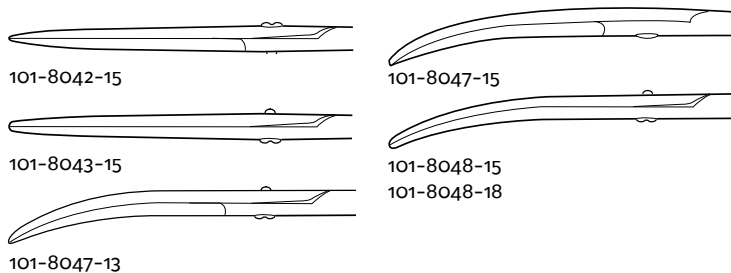

101-8042-15	Sharp/blunt	Straight	15 cm 6"
101-8043-15	Blunt/blunt	Straight	15 cm 6"
101-8047-13	Sharp/blunt	Curved	13.5 cm 5.25"
101-8047-15	Sharp/blunt	Curved	15 cm 6"
101-8048-15	Blunt/blunt	Curved	15 cm 6"
101-8048-18	Blunt/blunt	Curved	18 cm 7"



Mayo-Harrington STILLE operations sax | Mayo-Harrington STILLE Operating Scissors

Very useful operating scissors for deep surgery like gynecology and thoracic surgery. Beveled blades.

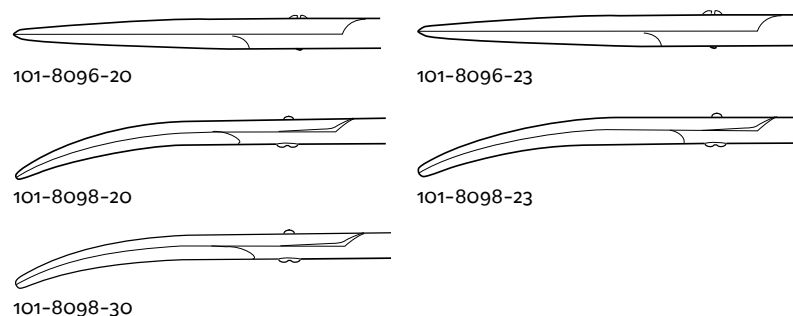

101-8096-20	Straight	20 cm 8"
101-8096-23	Straight	23 cm 9"
101-8098-20	Curved	20 cm 8"
101-8098-23	Curved	23 cm 9"
101-8098-30	Curved	30 cm 12"

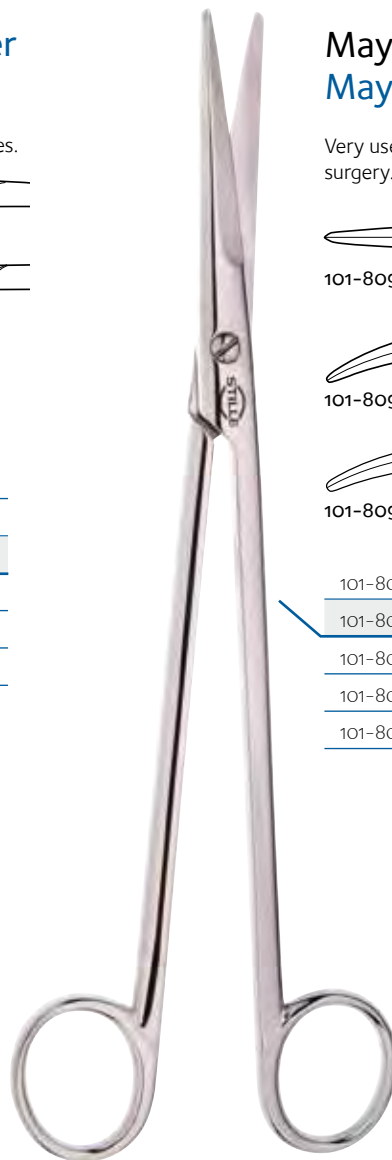

Mayo-Harrington STILLE SuperCut XE operations sax | Mayo-Harrington STILLE SuperCut XE Operating Scissors

Operating Super Cut scissors useful for several surgical disciplines. Beveled blades.

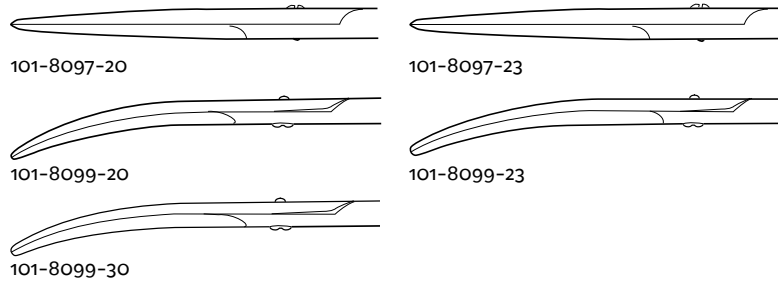

101-8097-20	Straight	20 cm 8"
101-8097-23	Straight	23 cm 9"
101-8099-20	Curved	20 cm 8"
101-8099-23	Curved	23 cm 9"
101-8099-30	Curved	30 cm 12"



Boyd-STILLE tonsillsax | Boyd-STILLE Tonsil Scissors

Scissors with sharp tips and S-shaped shanks for greater visibility. Rounded blades.



101-8420 Curved S-shaped shanks 17 cm 6.75"



Ragnell STILLE operations sax | Ragnell STILLE Operating Scissors

Mammary plastic scissors intended for breast surgery. Rounded blades.



101-8460

101-8460 Angled 17 cm 6.75"



König-STILLE nageluppklippnings sax | König-STILLE Nail-splitting Scissors

Nail-splitting scissors, for cutting up ingrown nails. Beveled blades.

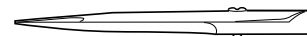

101-8580

101-8580 Straight 15 cm 6"



Stevens-STILLE tenotomisax | Stevens-STILLE Tenotomy Scissors

Tenotomy scissors with rounded, very thin blades and tapered tips. Used in plastic surgery and hand surgery for cutting with extreme precision in small incisions.



101-8166	Straight	12.5 cm 5"
101-8167	Curved	12.5 cm 5"



Stevens-STILLE SuperCut tenotomisax | Stevens-STILLE SuperCut Tenotomy Scissors

Very popular SuperCut XE scissors for precise cutting and dissection of fine tissues. Rounded blades.

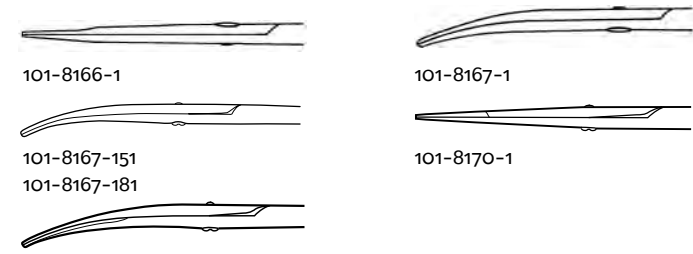

101-8166-1	Straight	12.5 cm 5"
101-8167-1	Curved	12.5 cm 5"
101-8167-151	Curved	15 cm 6"
101-8167-181	Curved	18 cm 7"
101-8170-1	Straight	9.5 cm 3.75"
101-8171-1	Curved	9.5 cm 3.75"



Stevens-STILLE Diamond SuperCut tenotomisax | Stevens-STILLE Diamond SuperCut Tenotomy Scissors

Diamond version for increased durability.

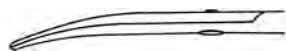

101-8167-1-C

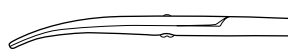

101-8167-151-C

101-8167-181-C

101-8167-1-C	Curved	12.5 cm 5"
101-8167-151-C	Curved	15 cm 6"
101-8167-181-C	Curved	18 cm 7"



Stevens-STILLE SuperCut XE ergonomisk tenotomisax | Stevens-STILLE SuperCut XE Ergonomic Tenotomy Scissors

Ergonomic design of the popular Stevens SuperCut XE tenotomy scissors.

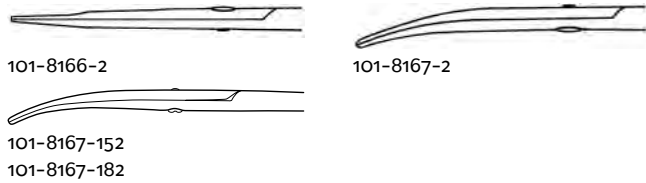

101-8166-2	Straight	12.5 cm 5"
101-8167-2	Curved	12.5 cm 5"
101-8167-152	Curved	15 cm 6"
101-8167-182	Curved	18 cm 7"



Stevens-STILLE Diamond SuperCut ergonomisk tenotomisax | Stevens-STILLE Diamond Ergonomic SuperCut Tenotomy Scissors

Diamond version for increased durability.

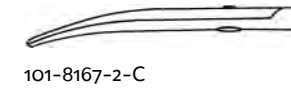

101-8167-2-C Curved 12.5 cm 5"



STILLE-Ekberg Stevens SuperCut ergonomisk tenotomisax | **STILLE-Ekberg Stevens Ergonomic SuperCut Tenotomy Scissors**

Ergonomic STILLE-Ekberg version. Available with blades curved up or down, suitable for both left- and right-handed surgeons.



101-8167-153D



101-8167-153U

101-8167-153D	Curved down	15 cm 6"
---------------	-------------	----------

101-8167-153U	Curved up	15 cm 6"
---------------	-----------	----------



STILLE-Ekberg Stevens Diamond SuperCut ergonomisk tenotomisax | **STILLE-Ekberg Stevens Diamond Ergonomic SuperCut Tenotomy Scissors**

Diamond version for increased durability.



101-8167-153D-C

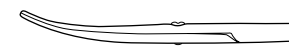

101-8167-153U-C

101-8167-153D-C	Curved down	15 cm 6"
-----------------	-------------	----------

101-8167-153U-C	Curved up	15 cm 6"
-----------------	-----------	----------



STILLE SuperCut XE kärlsax | STILLE SuperCut XE Vascular Scissors

Super Cut scissors with angled blades for better reach of vessels etc.
Used in vascular surgery.

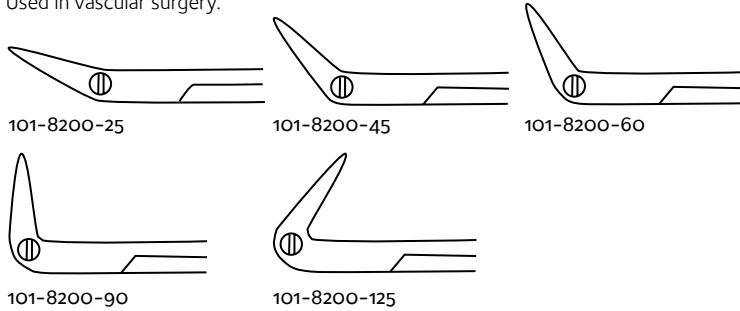

101-8200-25	Angled 25°	18 cm 7"
101-8200-45	Angled 45°	18 cm 7"
101-8200-60	Angled 60°	18 cm 7"
101-8200-90	Angled 90°	17 cm 6.75"
101-8200-125	Angled 125°	17 cm 6.75"

STILLE SuperCut XE kärlsax | STILLE SuperCut XE Vascular Scissors

Extra delicate version of the popular STILLE Vascular Scissor with shorter and thinner blades.

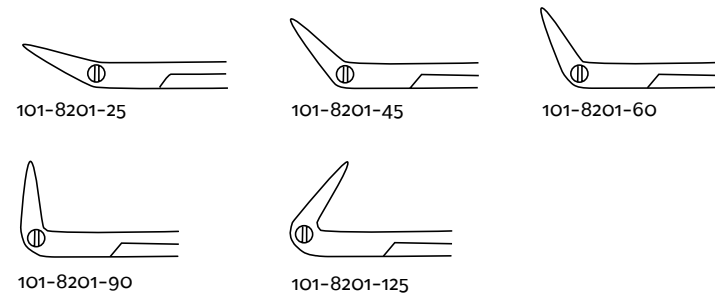

101-8201-25	Angled 25°	18 cm 7"
101-8201-45	Angled 45°	18 cm 7"
101-8201-60	Angled 60°	18 cm 7"
101-8201-90	Angled 90°	17 cm 6.75"
101-8201-125	Angled 125°	17 cm 6.75"

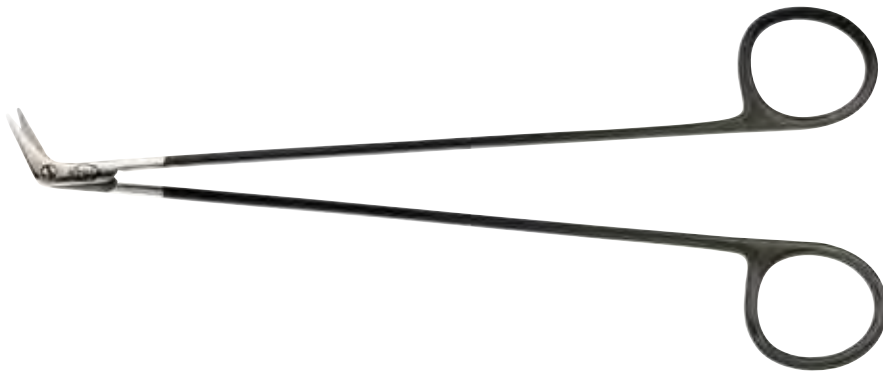

STILLE-Lund kärlsax | STILLE-Lund Vascular Scissors

Vascular scissors with one sharp and one probe-pointed blade for precise handling of fine blood vessels. Popular model in pathology procedures.

101-8490	1 probe-pointed blade		Straight	15 cm 6"
101-8490-2	1 probe-pointed blade	Ergo	Straight	15 cm 6"



Fomon STILLE nässax | Fomon STILLE Nasal Scissors

Scissors for rhinoplasty. Double-beveled blades.



101-8025

101-8025	Curved	12.5 cm 5"
----------	--------	------------



Joseph STILLE nässax | Joseph STILLE Nasal Scissors

Nasal scissors for the lower lateral cartilage. Useful in dissecting and cutting tough tissue. Beveled blades.



101-8110



101-8115

101-8110	Straight	15 cm 6"
----------	----------	----------

101-8115	Curved	15 cm 6"
----------	--------	----------

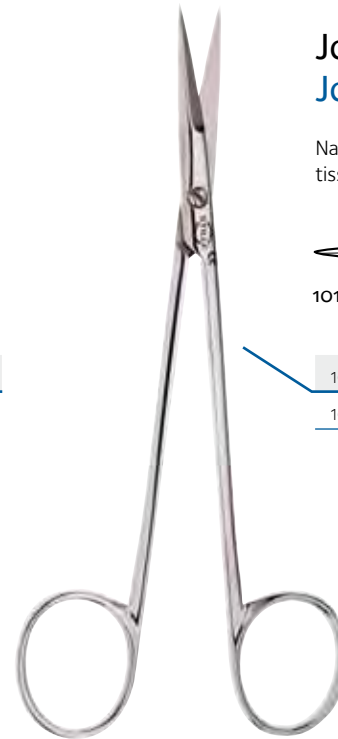

Joseph STILLE SuperCut XE nässax | Joseph STILLE SuperCut XE Nasal Scissors

Super Cut nasal scissors for the lower lateral cartilage. Useful in dissecting and cutting tough tissue. Beveled blades.



101-8110



101-8115

101-8110-1	Straight	15 cm 6"
------------	----------	----------

101-8115-1	Curved	15 cm 6"
------------	--------	----------



Peck-Joseph STILLE nässax | Peck-Joseph STILLE Nasal Scissors

Double-beveled scissors for rhinoplasty.

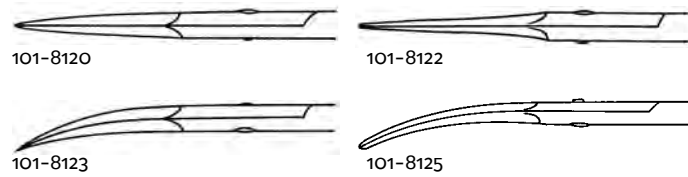

101-8120	Sharp	Straight	15 cm 6"
101-8122	Blunt	Straight	15 cm 6"
101-8123	Sharp	Curved	15 cm 6"
101-8125	Blunt	Curved	15 cm 6"

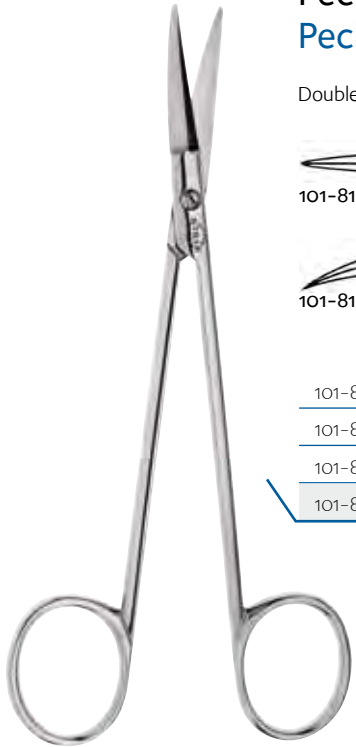

Peck-Joseph STILLE SuperCut XE nässax | Peck-Joseph STILLE SuperCut XE Nasal Scissors

Double-beveled scissors for rhinoplasty.

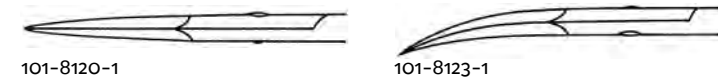

101-8120-1	Sharp	Straight	15 cm 6"
101-8123-1	Sharp	Curved	15 cm 6"



STILLE SuperCut XE nässax | STILLE SuperCut XE Nasal Scissors

SuperCut XE nasal scissors for excision of cartilage.



101-8411

101-8411 Straight Angled shanks 18 cm 7"



STILLE Fomon SuperCut XE nässax | STILLE Fomon SuperCut XE Nasal Scissors

Serrated SuperCut XE scissors for cutting dorsal cartilage. Angled shanks for better visibility.



101-8425

101-8425 Serrated blades Angled shanks 14 cm 5.5"



STILLE Cottle SuperCut XE nässax | STILLE Cottle SuperCut XE Nasal Scissors

SuperCut XE scissors with heavy blades for cutting dorsal cartilage. Angled shanks for better visibility. Serrated blades.

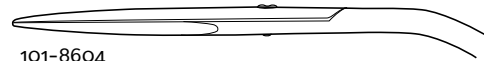

101-8604

101-8604 Serrated blades Angled shanks 16 cm 6.25"



Gorney STILLE SuperCut XE Face-lift sax | Gorney STILLE SuperCut XE Face-lift scissors

Super Cut double-beveled face-lift scissors with flat tips and semi-sharp outer blades. Two models with serrated blades to prevent tissue slippage.

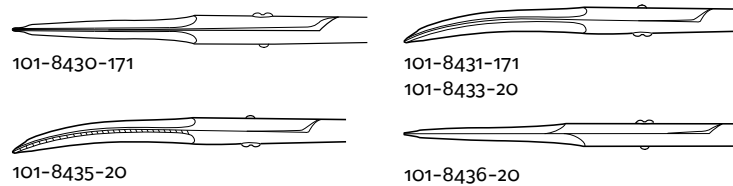
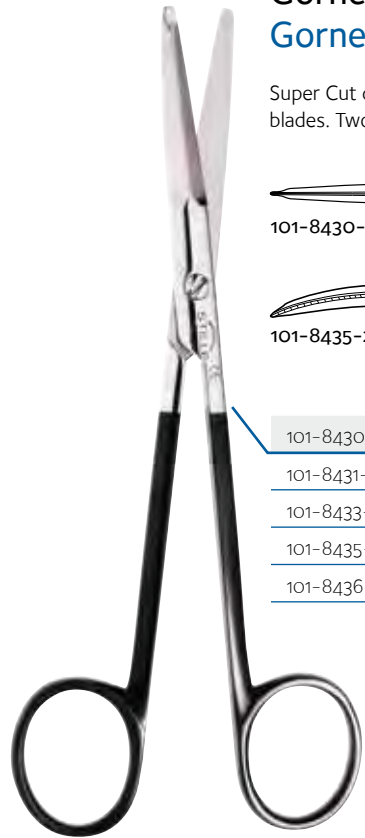

101-8430-171	Straight		17 cm 6.75"
101-8431-171	Curved		17 cm 6.75"
101-8433-20	Curved		20 cm 8"
101-8435-20	Curved	Serrated	20 cm 8"
101-8436-20	Straight	Serrated	20 cm 8"

Gorney STILLE SuperCut XE ergonomisk Face-lift sax | Gorney STILLE SuperCut XE Ergonomic Face-lift scissors

Ergonomic design to avoid fatigue in the hand. One model with serrated blades to prevent tissue slippage. Flat tips and semi-sharp outer blades.

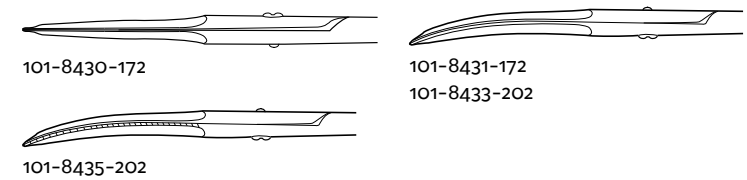
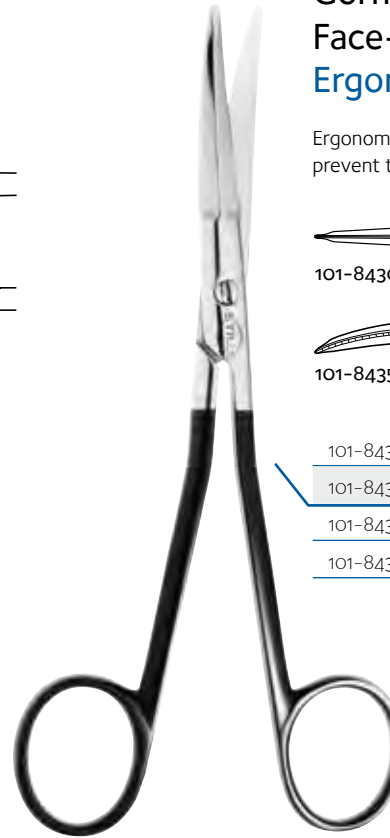

101-8430-172	Straight		17 cm 6.75"
101-8431-172	Curved		17 cm 6.75"
101-8433-202	Curved		20 cm 8"
101-8435-202	Curved	Serrated	20 cm 8"

Aston STILLE SuperCut XE Face-lift sax | Aston STILLE SuperCut XE Face-lift scissors

Double-beveled SuperCut XE face-lift scissors with semi-sharp outer blades for undermining flaps.



101-8440-201



101-8441-201



101-8442-171

101-8440-201	Straight		20 cm 8 in
101-8441-201	Curved		20 cm 8 in
101-8442-171	Curved	Serrated	17 cm 6.75 in



Davis STILLE SuperCut XE Face-lift sax | Davis STILLE SuperCut XE Face-lift Scissors

SuperCut XE face-lift scissors with tapered blades and sharp tips for precise cutting and dissection.



101-8452

101-8452 Curved 18 cm 7"

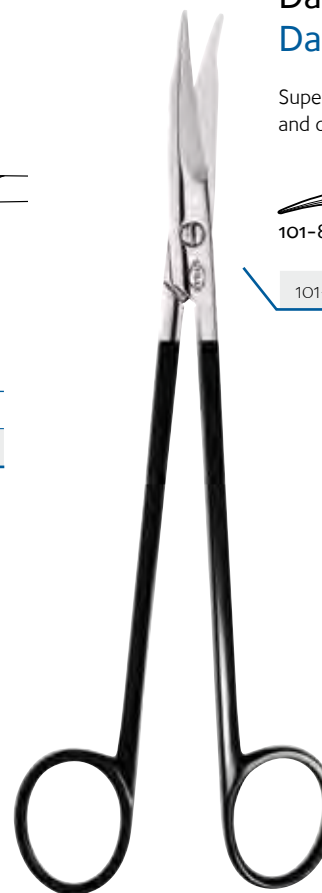

**Rees STILLE SuperCut XE Face-lift sax |
Rees STILLE SuperCut XE Face-lift scissors**

SuperCut XE face-lift scissors, double-beveled with semi-sharp outer blades for undermining skin flaps.



101-8456-171

101-8456-171	Curved	17 cm 6.75"
--------------	--------	-------------



**Matarasso STILLE SuperCut XE Face-lift sax |
Matarasso STILLE SuperCut XE Face-lift scissors**

SuperCut XE face-lift scissors with double-beveled semi-sharp outer blades.



101-8458



101-8459-20

101-8458-17	Curved	17 cm 6.75"
-------------	--------	-------------

101-8458-20	Curved	20 cm 8"
-------------	--------	----------

101-8459-20	Straight	20 cm 8"
-------------	----------	----------



**Matarasso STILLE SuperCut XE ergonomisk
Face-lift sax | Matarasso STILLE SuperCut XE
Ergonomic Face-lift scissors**

Ergonomic version of the Matarasso SuperCut XE face-lift scissors with double-beveled semi-sharp outer blades.



101-8458

101-8458-172	Curved	17 cm 6.75"
--------------	--------	-------------

101-8458-202	Curved	20 cm 8"
--------------	--------	----------



Littler STILLE trådföringssax | Littler STILLE Suture carrying scissors

Suture carrying scissors. Rounded blades.



101-8164

101-8164 Curved 12.5 cm 5"



STILLE sutursax | STILLE Suture scissors

Suture removal scissors.



101-8584

101-8584 Curved 13.5 cm 5.25"

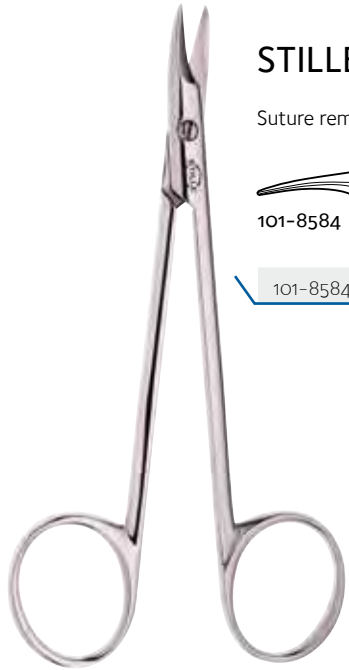

Spencer STILLE sutursax | Spencer STILLE Suture scissors

Popular suture scissors for many procedures. Delicate model.

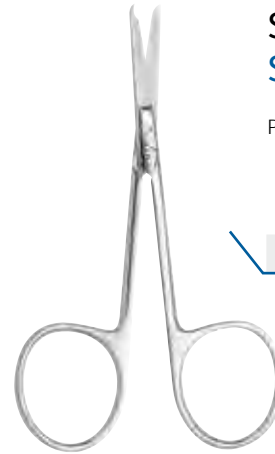

101-8586-9 9 cm 3.5"

Lister STILLE TC bandagesax | Lister STILLE TC Bandage Scissors

Bandage scissors with TC-inserts for improved durability.



101-8595-18 TC-inserts 18 cm 7"



**Littauer STILLE sutursax |
Littauer STILLE Suture scissors**

A somewhat larger model than Spencer. Used in many procedures.

101-8597-14 Delicate pattern 14 cm 5.5"

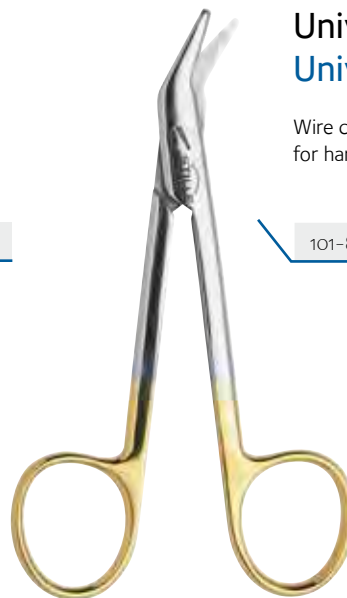

**Universal STILLE ståltrådssax |
Universal STILLE Wire Cutting scissors**

Wire cutting scissors with TC-inserts. For soft wire up to 1.2 mm,
for hard wire up to 0.8 mm.

101-8815-12 TC 12 cm 4.75"



SOM EN FÖRLÄNGNING av kirurgens tumme och pekfinger måste pincetten kunna fatta och släppa taget med samma känslighet som hos ett par fingertoppar. Klorna på de kirurgiska pincetterna är därför speciellt formgivna för att fatta ett fast, men ändå mildt, grepp om vävnaden. De anatomiska pincetterna är tillverkade för att kunna ta ett så atraumatiskt grepp som möjligt om känslig vävnad.

Det är finjusteringen som skapar den perfekta balansen med ett följsamt, fjädrande motstånd och ett stadigt grepp. Den karrerade ytan ökar greppbarheten ytterligare. Det ger kirurgen full kontroll samtidigt som det orsakar så lite skada på vävnaden som möjligt.

Pincetten hör till de kirurgiska instrument som grundaren Albert Stille lärde sig att tillverka från grunden redan under sina lärlingsår på 1830-talet. Ett till synes enkelt hjälpmedel som dock kräver exakt precision vid tillverkningen. Genom åren har STILLES pincetter fortsatt att förfinas och de är idag erkända för sin unikt mjuka känsla och goda balans i kombination med sin oöverträffade livslängd.

AS AN EXTENSION OF THE SURGEON'S THUMB and forefinger, forceps need to grasp and release with the same sensitivity as a pair of fingertips. The claws on surgical forceps are specially designed to make a firm, yet gentle, grasp of the tissue. The anatomical forceps are designed, as much as possible, to take an atraumatic grip on sensitive tissue.

It is the fine tuning that creates the perfect balance with a smooth, resilient spring action and a firm grip. The surface grooves increase gripping power even further. This gives the surgeon full control while causing as little harm to the tissue as possible.

Forceps are among the surgical instruments that founder Albert Stille learned to make from scratch during his apprenticeship in the 1830's. Forceps are seemingly simple instrument but still demands ultra-precision in the manufacturing process. Over the years, STILLE's forceps continue to be refined and are today recognized for their unique feel and excellent balance in combination with unsurpassed longevity.



Pincetter | Forceps | Pinzetten | Pinze | Pinzas |

鑷子 (ピンセット)

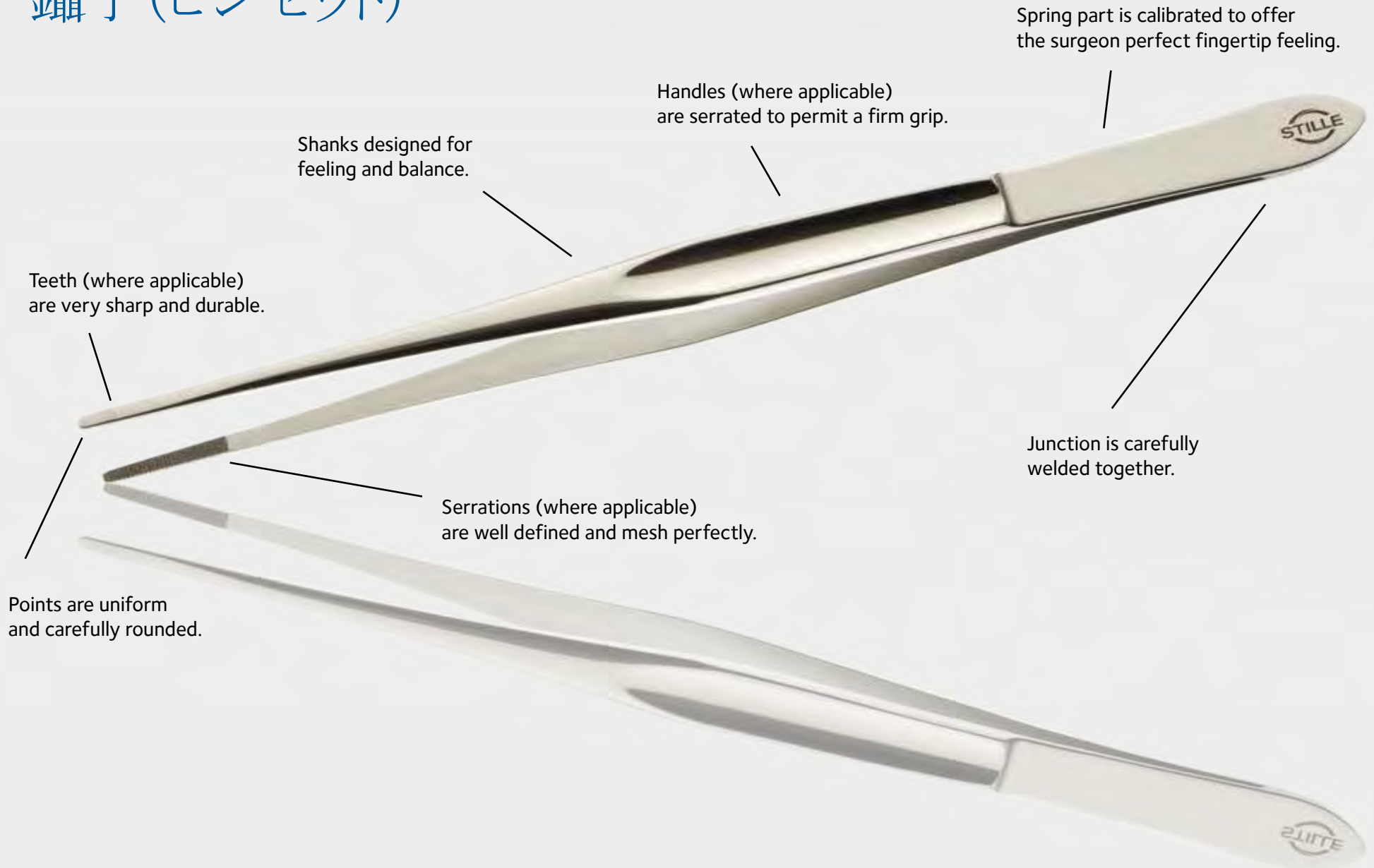



Adson STILLE pincett | Adson STILLE Tissue Forceps

Tissue forceps with very delicate points and 1x2 fine teeth. Used in most specialties for delicate work.



102-9019



102-9022
102-9022-15

102-9019	Very delicate	1x2 teeth	12 cm 4.75"
102-9022	Cross-serrated	1x2 teeth	12 cm 4.75"
102-9022-15	Cross-serrated	1x2 teeth	15 cm 6"



Adson-Callison STILLE pincett | Adson-Callison STILLE Tissue Forceps

Tissue forceps with tying platform and 1x2 fine teeth.



102-9021

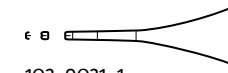

102-9021-1

102-9021	Tying platform	1x2 teeth	12 cm 4.75"
102-9021-1	Delicate tying platform	1x2 teeth	12 cm 4.75"



Adson-Brown STILLE pincett | Adson-Brown STILLE Tissue Forceps

Tissue forceps with side-grasping teeth for secure, atraumatic grasping of soft tissue or cartilage.



102-9023-12

102-9023-12	Side-grasping teeth	12 cm 4.75"
-------------	---------------------	-------------

Gillies STILLE pincett | Gillies STILLE Tissue Forceps

Tissue forceps with 1x2 fine teeth and stabilizing pin. An excellent forceps for the surgeon who wants an Adson-size tip, but with greater length.



102-9027

102-9027	Serrated	1x2 fine teeth	15,5 cm 6.25"
----------	----------	----------------	---------------



STILLE pincett | STILLE Tissue Forceps

Tissue forceps with 1x2 fine teeth and stabilizing pin. Delicate model.

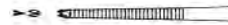

102-9028

102-9028	Serrated	1x2 fine teeth	15,5 cm 6.25"
----------	----------	----------------	---------------



STILLE pincett | STILLE Tissue Forceps

Tissue forceps with 1x2 teeth.



102-9060

102-9060-15	1x2 teeth	15 cm 6"
102-9060-17	1x2 teeth	17 cm 6.75"
102-9060-20	1x2 teeth	20 cm 8"



STILLE pincett | STILLE Tissue Forceps

Tissue forceps with 1x2 fine teeth.



102-9050-13

102-9050-13	1x2 fine teeth	13 cm 5"
-------------	----------------	----------



STILLE pincett | STILLE Tissue Forceps

Tissue forceps with 2x3 teeth. Used when more grasping power than 1x2 teeth is needed.



102-9062

102-9062-15	2x3 teeth	15 cm 6"
102-9062-17	2x3 teeth	17 cm 6.75"
102-9062-20	2x3 teeth	20 cm 8"





Adlercreutz STILLE pincett | Adlercreutz STILLE Tissue Forceps

Tissue forceps with 4x5 fine teeth. Very useful in neurosurgery to hold the dura, and in cardiovascular surgery to hold the pericardium.



102-9248-15	4x5 fine teeth	15 cm 6"
102-9248-20	4x5 fine teeth	20 cm 8"
102-9248-25	4x5 fine teeth	25 cm 10"

Waugh-Brophy STILLE pincett | Waugh-Brophy STILLE Tissue Forceps

Tissue forceps with 1x2 fine teeth. Very fine tips, like Adson. Useful when long and slender instruments are needed.



102-9252

102-9252-20	1x2 teeth	Cross-serrated	20 cm 8"
102-9252-25	1x2 teeth	Cross-serrated	25 cm 10"
102-9252-30	1x2 teeth	Cross-serrated	30 cm 12"



Russian STILLE pincett | Russian STILLE Tissue Forceps

Forceps for secure grip of tissue. Used when a better grip than with a dressing forceps is needed, and when damage to the tissue must be avoided. For hard and slippery tissue.

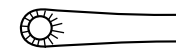

102-9270-20

102-9270-20	20 cm 8"
-------------	----------





Adson STILLE anatomisk pincett | Adson STILLE Dressing Forceps

General-purpose dressing forceps with various types of jaw surfaces.



102-9020	Serrated	12 cm 4.75"
102-9020-15	Serrated	15 cm 6"
102-9020-1	Diamond jaws	12 cm 4.75"
102-9024	TC jaws cross-serrated	12 cm 4.75"



McIndoe STILLE anatomisk pincett | McIndoe STILLE Dressing Forceps

Dressing forceps with stabilizing pin and delicate jaws for grasping fine tissue.

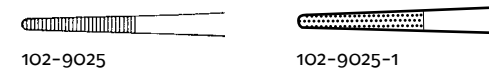

102-9025	Serrated	15.5 cm 6.25"
102-9025-1	Diamond Jaws	15.5 cm 6.25"

STILLE anatomisk pincett | STILLE Dressing Forceps

Dressing forceps with square shaped and serrated points used in all surgical specialties.



102-9030-13	Square points	13 cm 5"
102-9030-15	Square points	15 cm 6"
102-9030-17	Square points	17 cm 6.75"
102-9030-20	Square points	20 cm 8"
102-9030-25	Square points	25 cm 10"



STILLE anatomisk pincett | STILLE Dressing Forceps

Dressing forceps with rounded points and serrated jaws.



102-9040-15	Rounded points	15 cm 6"
102-9040-17	Rounded points	17 cm 6.75"
102-9040-20	Rounded points	20 cm 8"
102-9040-25	Rounded points	25 cm 10"
102-9040-30	Rounded points	30 cm 12"





**Crafoord-STILLE anatomisk pincett |
 Crafoord-STILLE Dressing Forceps**

Dressing forceps with rounded points. The perfect balance and delicate grip gives this instrument a unique feeling.



102-9077-20



102-9078-20

102-9077-20	Serrated	20 cm 8"
-------------	----------	----------

102-9078-20	Diamond jaws	20 cm 8"
-------------	--------------	----------



**Waugh-Brophy STILLE anatomisk pincett |
 Waugh-Brophy STILLE Dressing Forceps**

Dressing forceps with very fine points and two different jaw surfaces. The cross-serration gives excellent holding power.



102-9254



102-9255-20

102-9255-25

102-9254	Cross- serrated	20 cm 8"
----------	-----------------	----------

102-9255-20	Diamond jaws	20 cm 8"
-------------	--------------	----------

102-9255-25	Diamond jaws	25 cm 10"
-------------	--------------	-----------

Olivecrona-STILLE durapincett | Olivecrona-STILLE Dura Forceps

Dura forceps with 2x3 fine teeth. The nonpenetrating tips give the surgeon maximum grip without damaging the tissue.



102-9244-15 2x3 fine teeth 15 cm 6"

102-9244-20 2x3 fine teeth 20 cm 8"

102-9244-25 2x3 fine teeth 25 cm 10"



STILLE irispincett | STILLE Iris Forceps

Short delicate forceps with either 1x2 fine teeth or serrated jaws.



102-9460

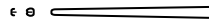

102-9470

102-9460	Serrated	10 cm 4"
102-9470	1x2 teeth	10 cm 4"





STILLE De Bakey kärlpincett | STILLE De Bakey Vascular Forceps

Atraumatic forceps with De Bakey jaws for handling of blood vessels and other delicate tissue. Can be insulated on request.

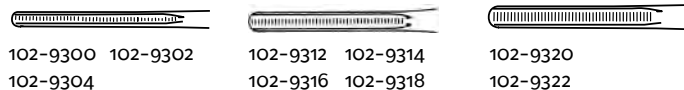

102-9340	De Bakey type	1 mm	15 cm 6"
102-9342	De Bakey type	1 mm	20 cm 8"
102-9354	De Bakey type	1.5 mm	25 cm 10"
102-9300	De Bakey type	2 mm	15 cm 6"
102-9302	De Bakey type	2 mm	20 cm 8"
102-9304	De Bakey type	2 mm	25 cm 10"
102-9312	De Bakey type	2.7 mm	15 cm 6"
102-9314	De Bakey type	2.7 mm	20 cm 8"
102-9316	De Bakey type	2.7 mm	25 cm 10"
102-9318	De Bakey type	2.7 mm	30 cm 11.75"
102-9320	De Bakey type	3.2 mm	20 cm 8"
102-9322	De Bakey type	3.2 mm	25 cm 10"



STILLE De Bakey kärlpincett | STILLE De Bakey Vascular Forceps

Angled atraumatic forceps with De Bakey jaws for delicate tissue.

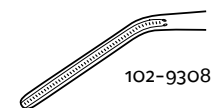

102-9308 De Bakey type 2 mm 20 cm 8"



STILLE De Bakey kärlpincett | STILLE De Bakey Vascular Forceps

Atraumatic forceps with De Bakey jaws for delicate tissue, non serrated handles. Stop pin for preventing from gripping the tissue too hard.

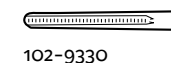

102-9330

102-9330 De Bakey type 2 mm 20 cm 8"



**Waugh-Brophy STILLE isolerad diatermipincett |
 Waugh-Brophy STILLE insulated Diathermy
 Forceps**

Insulated version of the popular Waugh-Brophy forceps. Used in monopolar diathermy with 1x2 teeth.



102-9852

102-9852-20 1x2 teeth Cross-serrated 20 cm 8"

102-9852-25 1x2 teeth Cross-serrated 25 cm 10"

102-9852-30 1x2 teeth Cross-serrated 30 cm 12"

**Björk-STILLE diatermipincetter | Björk-STILLE
 Diathermy Forceps**

Insulated forceps for monopolar diathermy. Serrations allow grasping of delicate structures.



102-9845

102-9845-15 Insulated 15 cm 6"

102-9845-20 Insulated 20 cm 8"

102-9845-25 Insulated 25cm 10"

**Waugh-Brophy STILLE isolerad diatermipincett |
 Waugh-Brophy STILLE insulated Diathermy
 Forceps**

Insulated version of the popular Waugh-Brophy forceps. Used in monopolar diathermy. With Diamond Jaws.



102-9855

102-9855-20 Diamond jaws 20 cm 8"

102-9855-25 Diamond jaws 25 cm 10"



Björk-STILLE knutpincett | Björk-STILLE Knot-Holding Forceps

Same as Björk-STILLE diathermy forceps, but without insulation.



102-9846-20

102-9846-20

20 cm 8 in





STILLES PEANGER har en unik och gracil design med mjuka former, alltid med kirurgens specifika behov i fokus. Det öppna boxlåset förenklar rengöringen och minimerar risken för att kirurgens handskar eller suturer ska fastna i instrumentet. Utformningen av det speciella knäppet är unik och håller alltid peangen stängd i en säker position. Samtidigt är knäppet mycket lätt och smidigt att öppna så att kirurgen hela tiden har full kontroll.

Käftarna har rundade kanter och perfekt passform mot varandra. Det finns ingen risk för att de ska släppa greppet. Peangen stängs och öppnas lika snabbt och smidigt med ett enkelt handgrepp. Därför upplevs den som mycket mjukare och med en spänst som inga andra fabrikat kan erbjuda.

Konstruktionen har fortsatt att förbättras under årens lopp och många försök har gjorts att kopiera STILLES egenutvecklade design. Den oöverträffade livslängden gör peangerna till en god investering som kan användas under många år.

STILLE'S ARTERY FORCEPS have a unique and graceful design featuring soft shapes, always with the surgeon's specific needs in mind. The open box lock simplifies cleaning and minimizes the risk of the surgeon's gloves or sutures becoming entangled in the instrument. The design of the special ratchet is unique and always keeps the forceps closed in a secure position. At the same time the ratchet is very easy and convenient to open, giving the user full control.

The jaws have rounded edges and fit perfectly together. There is no risk of losing grip. The instrument closes and opens quickly and smoothly with a simple operation. STILLE artery forceps have a softer feel with performance properties that no other brand can offer.

The manufacturing technique has continued to improve over the years and many attempts have been made to imitate STILLE's proprietary design. The unsurpassed longevity makes these instruments a good investment that will be in service for many years.

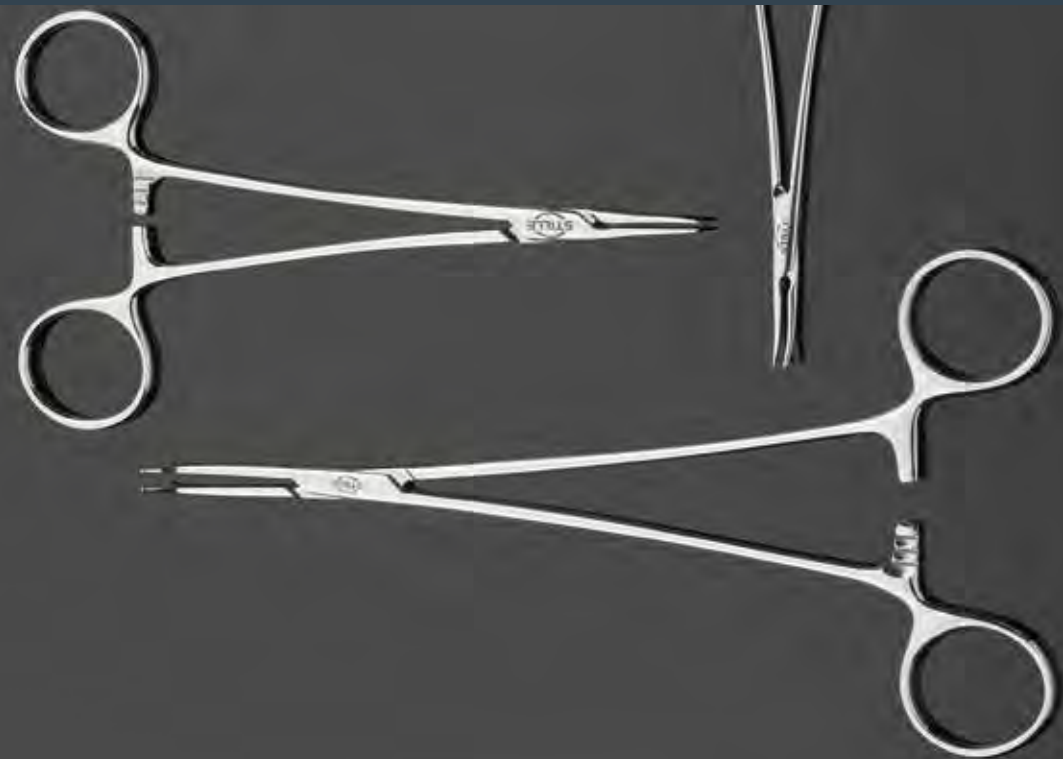

Peanger | Artery forceps | Arterienklemmen |
Pinze emostatiche | Pinzas hemostáticas | 止血鉗子

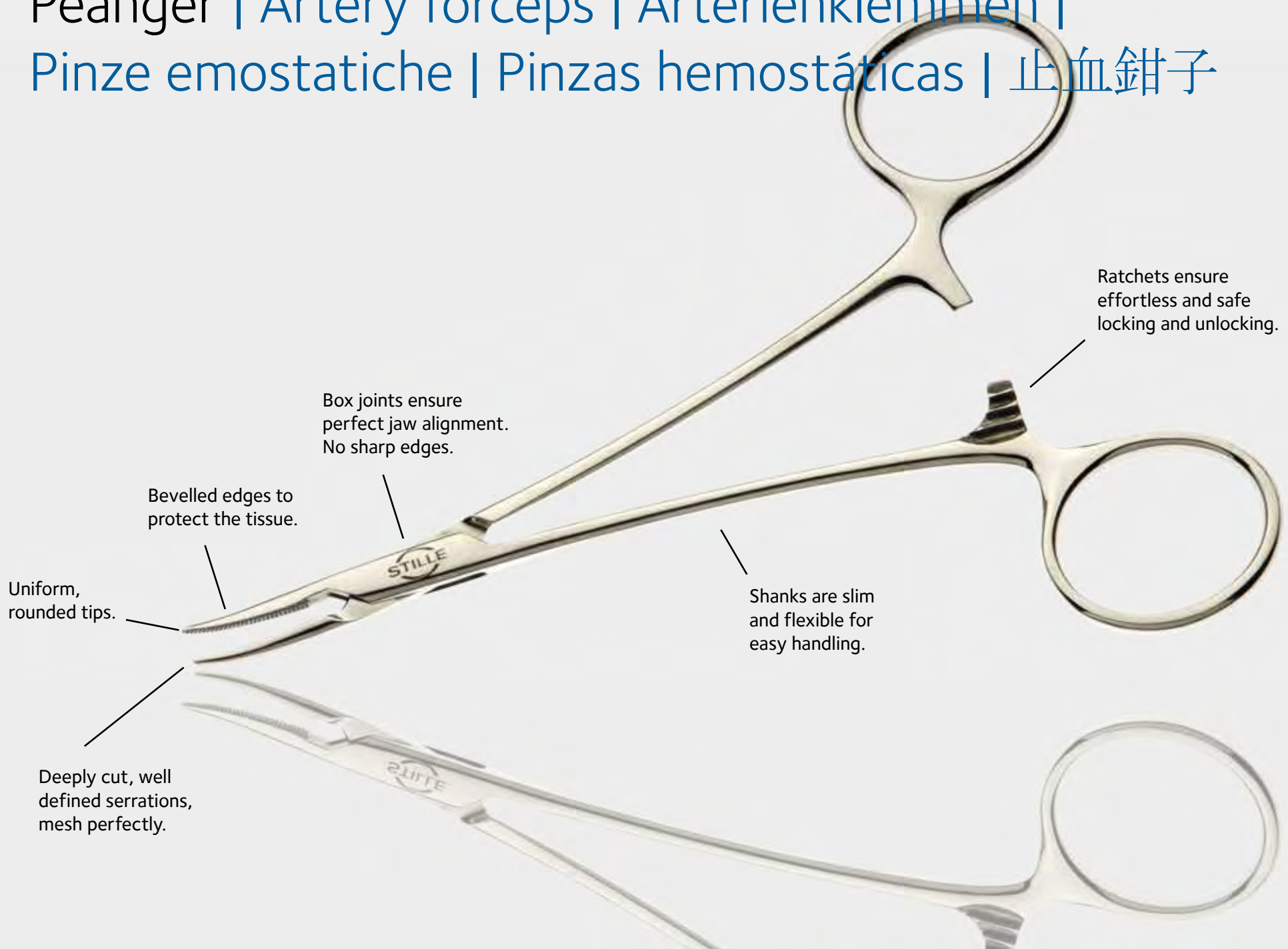

Ratchets ensure effortless and safe locking and unlocking.

Box joints ensure perfect jaw alignment. No sharp edges.

Bevelled edges to protect the tissue.

Uniform, rounded tips.

Shanks are slim and flexible for easy handling.

Deeply cut, well defined serrations, mesh perfectly.



Pean STILLE peang | Pean STILLE Artery Forceps

General utility forceps used in many surgical disciplines.

103-10015-131	Straight	13.5 cm 5.25"
---------------	----------	---------------

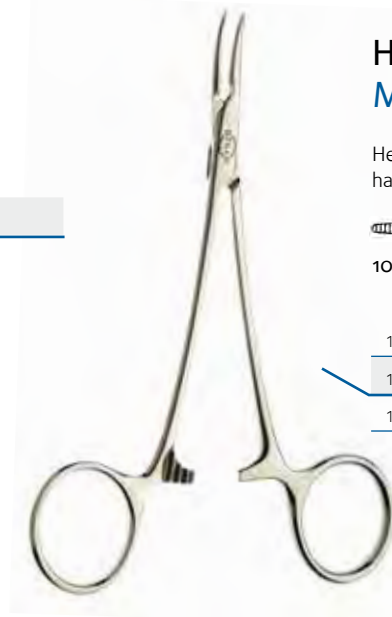

Halsted-Mosquito STILLE peang | Halsted-Mosquito STILLE Artery Forceps

Hemostat without teeth, used in small operative fields. For plastic surgery, neuro, hand or any delicate surgery.



103-10030-121			
103-10032-121			
103-10032-181			

103-10030-121	Straight	12 cm 4.75"
103-10032-121	Curved	12 cm 4.75"
103-10032-181	Curved	18 cm 7"



Halsted-Mosquito STILLE gracil peang | Halsted-Mosquito STILLE delicate Artery Forceps

Delicate hemostat without teeth for small operating field.



103-10026-121		
103-10028-121		

103-10026-121	Straight	12 cm 4.75"
103-10028-121	Curved	12 cm 4.75"

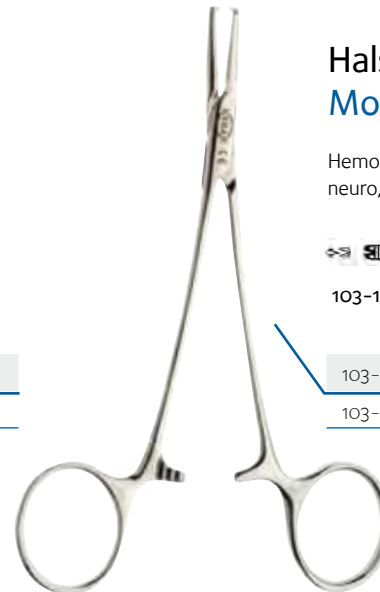

Halsted-Mosquito STILLE peang | Halsted-Mosquito STILLE Artery Forceps

Hemostat with 1x2 teeth, used in small operative fields. For plastic surgery, neuro, hand or any delicate surgery.



103-10035-121		
103-10037-121		

103-10035-121	1x2 teeth	Straight	12 cm 4.75"
103-10037-121	1x2 teeth	Curved	12 cm 4.75"

Kocher STILLE peang | Kocher STILLE Artery Forceps

Hemostat with 1x2 teeth. Widely used when a short instrument is needed. Can also be used as tissue forceps to retract or lift an organ.



103-10115-141

103-10115-141	1x2 teeth	Straight	14 cm 5.5"
103-10117-141	1x2 teeth	Curved	14 cm 5.5"



Kelly STILLE peang | Kelly STILLE Artery Forceps

Fairly short hemostat with jaws, half-serrated.

103-10150-141	Straight	14 cm 5.5"
103-10152-141	Curved	14 cm 5.5"



Kelly-Rankin STILLE peang | Kelly-Rankin STILLE Artery Forceps

Longer version of the Kelly hemostat with jaws half-serrated.



103-10160-161	Straight	16 cm 6.25"
103-10162-161	Curved	16 cm 6.25"

Christophe-STILLE peang | Christophe-STILLE Artery Forceps

Curved hemostat without teeth.

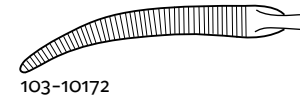
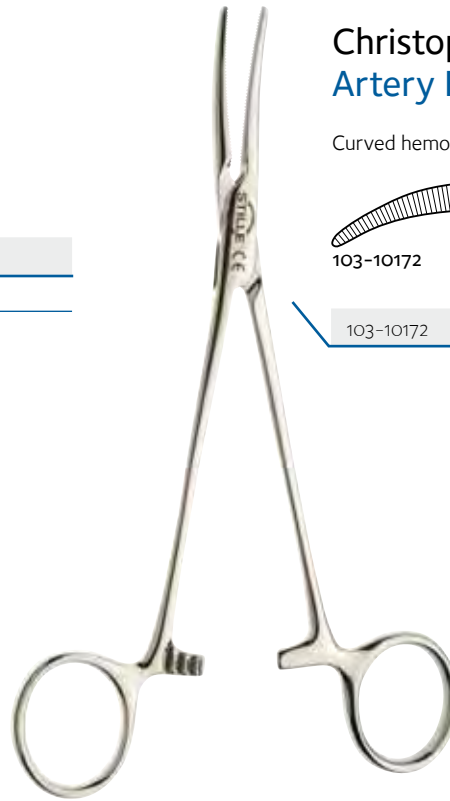

103-10172

103-10172	Curved	16 cm 6.25"
-----------	--------	-------------

Crile STILLE peang | Crile STILLE Artery Forceps

General purpose hemostat without teeth. Used in relatively small operating fields, when more strength is needed than a Mosquito can offer.

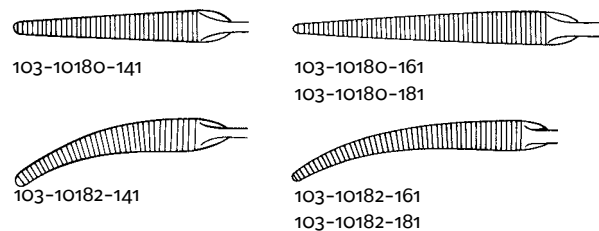

103-10180-141	Straight	14 cm 5.5"
103-10180-161	Straight	16 cm 6.25"
103-10180-181	Straight	18 cm 7"
103-10182-141	Curved	14 cm 5.5"
103-10182-161	Curved	16 cm 6.25"
103-10182-181	Curved	18 cm 7"



Crile STILLE peang | Crile STILLE Artery Forceps

General purpose hemostat with 1x2 teeth. Used in relatively small operating fields, when more strength is needed than a Mosquito can offer.

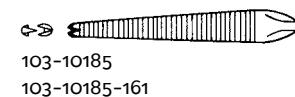

103-10185	1x2 teeth	Straight	14 cm 5.5"
103-10185-161	1x2 teeth	Straight	16 cm 6.25"
103-10187-141	1x2 teeth	Curved	14 cm 5.5"
103-10187-161	1x2 teeth	Curved	16 cm 6.25"



Leriche STILLE peang | Leriche STILLE Artery Forceps

Fairly tapered hemostat. For use in small operative fields.

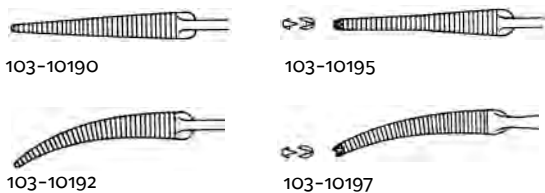

103-10190		Straight	15 cm 6"
103-10192		Curved	15 cm 6"
103-10195	1x2 teeth	Straight	15 cm 6"
103-10197	1x2 teeth	Curved	15 cm 6"



Rochester-Péan STILLE peang | Rochester-Péan STILLE Artery Forceps

Sturdy hemostat. Relatively blunt tips. Used in all types of surgery.

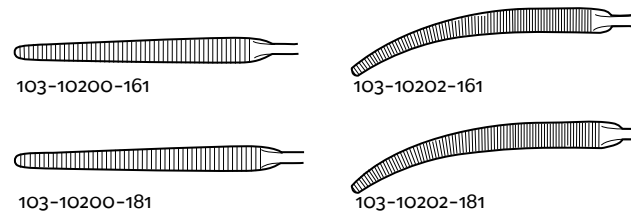

103-10200-161		Straight	16 cm 6.25"
103-10200-181		Straight	18 cm 7"
103-10202-161		Curved	16 cm 6.25"
103-10202-181		Curved	18 cm 7"



Rochester-Ochsner STILLE peang | Rochester-Ochsner STILLE Artery Forceps

Sturdy hemostat with 1x2 teeth. Used when a strong forceps is needed, both to occlude blood vessels and to lift or retract organs.

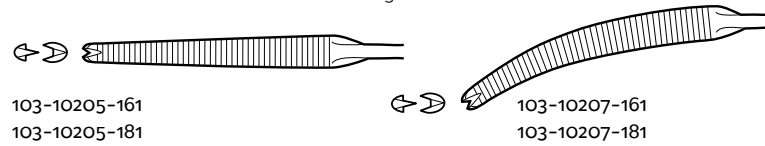

103-10205-161	1x2 teeth	Straight	16 cm 6.25"
103-10205-181	1x2 teeth	Straight	18 cm 7"
103-10207-161	1x2 teeth	Curved	16 cm 6.25"
103-10207-181	1x2 teeth	Curved	18 cm 7"



Rochester-Péan STILLE peang | Rochester-Péan STILLE Artery Forceps

Sturdy hemostats. The 20 cm has short and the 24 cm has long jaws. Also referred to as hysterectomy forceps.

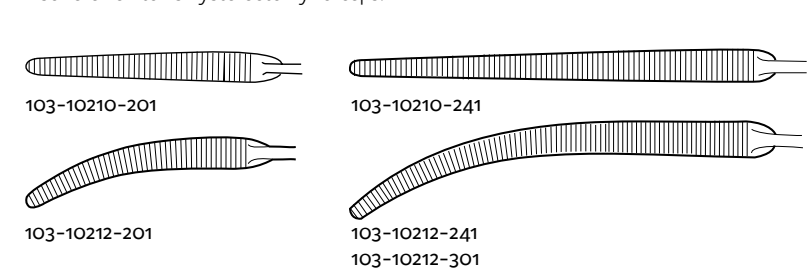

103-10210-201	Straight	20 cm 8"
103-10210-241	Straight	24 cm 9.5"
103-10212-201	Curved	20 cm 8"
103-10212-241	Curved	24 cm 9.5"
103-10212-301	Curved	30 cm 12"



Rochester-Ochsner STILLE peang | Rochester-Ochsner STILLE Artery Forceps

Sturdy hemostat with 1x2 teeth. Used when a strong and long forceps is needed, both to occlude blood vessels and to lift or retract organs.

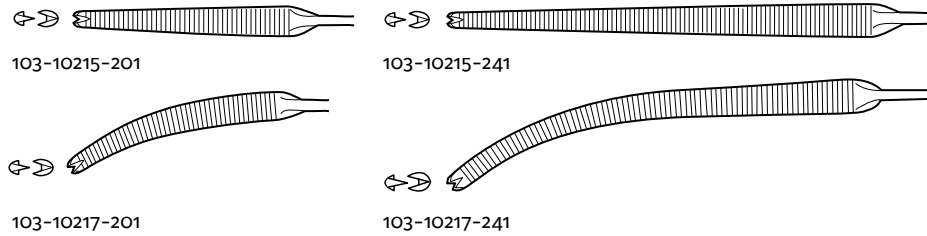

103-10215-201	1x2 teeth	Straight	20 cm 8"
103-10215-241	1x2 teeth	Straight	24 cm 9.5"
103-10217-201	1x2 teeth	Curved	20 cm 8"
103-10217-241	1x2 teeth	Curved	24 cm 9.5"



Bengolea STILLE peang | Bengolea STILLE Artery Forceps

A long hemostat with straight or curved jaws without teeth.

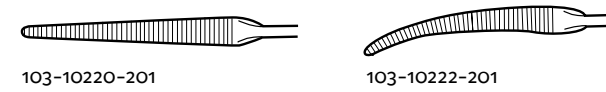

103-10220-201	Straight	20 cm 8"
103-10222-201	Curved	20 cm 8"



Olivecrona STILLE peang | Olivecrona STILLE Artery Forceps

16 cm straight hemostat. Useful as a long hemostat with fine points.



103-10240-161

103-10240-161	Straight	16 cm 6.25"
---------------	----------	-------------



Adson STILLE peang | Adson STILLE Artery Forceps

Popular model when a little longer and fairly delicate hemostat is needed.

103-10260-191	Straight	19 cm 7.5"
103-10262-191	Curved	19 cm 7.5"



Dandy STILLE peang | Dandy STILLE Artery Forceps

Side curved hemostat without teeth. Often used in neuro surgery.



103-10310

103-10310 14 cm 5.5"



Schmidt STILLE peang | Schmidt STILLE Artery Forceps

A hemostat popular in general surgery.

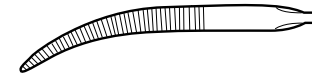

103-10411-201

103-10411-201 Curved 20 cm 8"



Sawtell STILLE peang | Sawtell STILLE Artery Forceps

A hemostat with half-serrated and fairly strongly curved jaws.

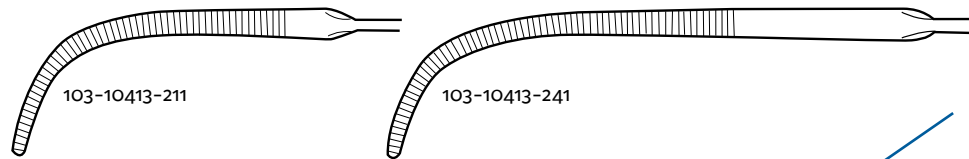

103-10413-211	Curved	21 cm 8.25"
103-10413-241	Curved	24 cm 9.5"



Heiss STILLE peang | Heiss STILLE Artery Forceps

Dissecting and ligature clamps with half-serrated, jaws.

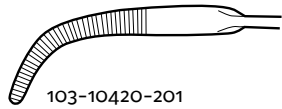

103-10421-211	Straight	21 cm 8.25"
103-10422-211	Curved	21 cm 8.25"
103-10420-201	Strongly curved	20 cm 8"



Overholt STILLE peang | Overholt STILLE Dissecting Forceps

Strongly curved dissecting forceps.

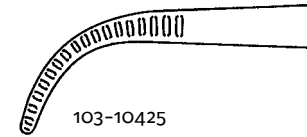

103-10425	Strongly curved	14 cm 5.5"
-----------	-----------------	------------



Crafoord STILLE peang | Crafoord STILLE Artery Forceps

Designed for thoracic and cardiovascular surgery. The fine tips make this a very useful instrument. Offers the surgeon Mosquito type tips, but with a length that allows working in a deep cavity.

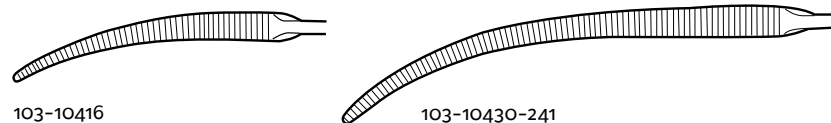

103-10416	Curved	18 cm 7"
103-10430-241	Curved	24 cm 9.5"



STILLE artär- och ligaturklämmare | STILLE Artery and Ligature Clamp

Four very delicate models of dissecting forceps with different jaw curvature.

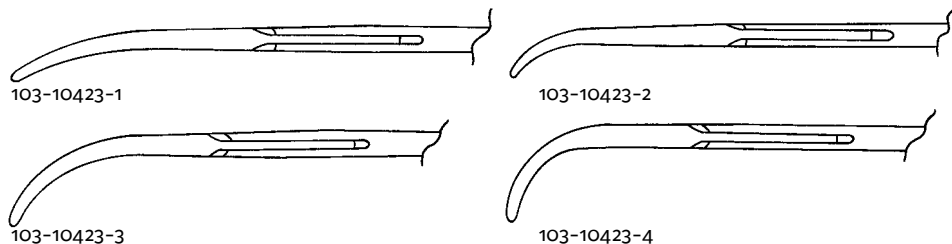

103-10423-1	Slightly curved	20 cm 8"
103-10423-2	Curved	20 cm 8"
103-10423-3	Strongly curved	19,5 cm 7.75"
103-10423-4	Angled 90°	19 cm 7,5"



STILLE-Ehrén ligaturklämmare | STILLE-Ehrén Ligature Clamp

For fine and precise handling of ligatures in very narrow areas, such as paediatric surgery. The jaws close only at the tips to minimize the risk for accidental clamping of fragile vessels etc. Developed together with Henrik Ehrén, M.D. at Karolinska University Hospital. Matted finish.

103-10428-151 Delicate Strongly curved 15 cm 6"





FÖR ETT FULLGOTT RESULTAT VID SUTURERING krävs ett pålitligt och tåligt instrument. STILLES nålförare känns lätt igen på den gracila och mjuka designen vilket hjälper kirurgen att hålla nålen i ett mycket säkert grepp. De gyllene fingeröglorna indikerar att käftarna är försedda med inlägg av hårdmetall vilket förlänger hållbarheten. Vissa nålförare är istället belagda med Diamond Jaws där hårdmetallen har sprutats på som ett tunt skikt på insidan av käftarna.

Ett annat säkert kännetecken för STILLES nålförare är det öppna boxlåset vilket minskar risken för att nålföraren ska fastna i suturen eller kirurgens handskar. Samtidigt förenklas rengöring och sterilisering. Knäppets unika utformning ser till att nålföraren hålls stängd i ett säkert läge samtidigt som den är enkel att öppna igen. Alla dessa egenskaper ligger bakom den där speciella känslan som instrument från STILLE ger.

För exakt matchning av suturer och nålförare, se separat guide för passande suturstorlek till varje nålförare.



A PERFECT RESULT WHEN SUTURING requires a reliable and durable instrument. STILLE needle holders are easily recognized by their delicate and soft design, which helps the surgeon to hold the needle very securely. The golden finger loops indicate that the jaws are fitted with inserts of hard metal, which prolongs the life of the instrument. Some needle holders are instead coated with Diamond Jaws where hard metal is sprayed on as a thin layer on the inside of the jaws.

Another feature of STILLE's needle holders is the open box lock. This reduces the risk of the needle holder being caught in the sutures or the surgeon's gloves. It also simplifies the cleaning and sterilization process. The ratchet's unique design ensures that the instrument stays closed in a safe position while remaining easy to open. All of these features are characteristic of that special feel that instruments from STILLE provide.

For precise matching of sutures and needle holders, see the separate guide for matching suture size to individual needle holders.

Nålförare | Needle holders | Nadelhalter | Portaghi | Porta-agujas | 持針器

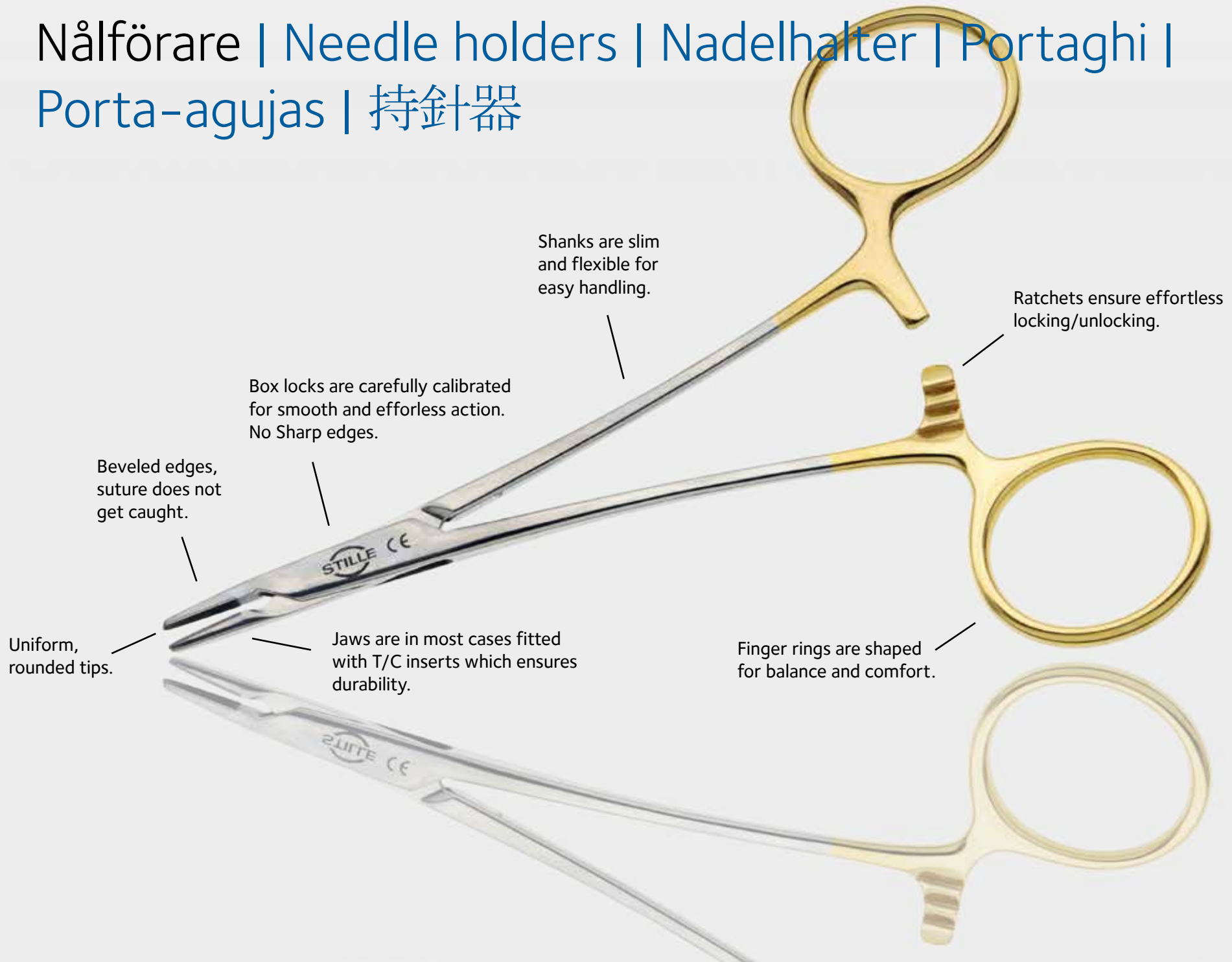



Art.no	Description	Max suture size
104-15542	RAPP-STILLE KNOT-HOLDING FORCEPS 13 cm 5"	3/0
104-15545	WEBSTER STILLE very delicate DD jaws 12 cm 4.75"	5/0
104-15546	WEBSTER STILLE very delicate smooth 12 cm 4.75"	5/0
104-15549-131	KILNER STILLE TC jaws 13 cm 5"	4/0
104-15550	GILLIES STILLE serrated 16 cm 6.25"	2/0
104-15551	GILLIES STILLE TC jaws 16 cm 6.25"	2/0
104-15556	WEBSTER STILLE delicate smooth 12 cm 4.75"	4/0
104-15557	WEBSTER-KLEINERT STILLE smooth offset bows 12 cm 4.75"	4/0
104-15558	WEBSTER STILLE smooth TC jaws 12 cm 4.75"	3/0
104-15559	WEBSTER STILLE serrated TC jaws 12 cm 4.75"	4/0
104-15560	HALSEY STILLE TC jaws 12.5 cm 5"	3/0
104-15560-2	HALSEY STILLE ERGONOMIC TC jaws 12.5 cm 5"	3/0
104-15561-141	MAYO-HEGAR STILLE TC jaws 14 cm 5.5"	0
104-15561-161	MAYO-HEGAR STILLE TC jaws 16 cm 6.25"	0
104-15561-181	MAYO-HEGAR STILLE TC jaws 18 cm 7"	0
104-15561-201	MAYO-HEGAR STILLE TC jaws 20 cm 8"	0
104-15561-251	MAYO-HEGAR STILLE TC jaws 25 cm 10"	0
104-15562-161	MAYO-HEGAR STILLE Heavy Pattern TC jaws 16 cm 6.25"	1
104-15562-181	MAYO-HEGAR STILLE Heavy Pattern TC jaws 18 cm 7"	1
104-15562-201	MAYO-HEGAR STILLE Heavy Pattern TC jaws 20 cm 8"	1
104-15562-241	MAYO-HEGAR STILLE Heavy Pattern TC jaws 24 cm 9.5"	1
104-15562-271	MAYO-HEGAR STILLE Heavy Pattern TC jaws 27 cm 10.5"	1
104-15562-301	MAYO-HEGAR STILLE Heavy Pattern TC jaws 30 cm 12"	1
104-15565-151	CRILE-WOOD STILLE TC jaws 15 cm 6"	2/0
104-15565-181	CRILE-WOOD STILLE TC jaws 18 cm 7"	2/0
104-15565-201	CRILE-WOOD STILLE TC jaws 20 cm 8"	2/0
104-15565-231	CRILE-WOOD STILLE TC jaws 23 cm 9"	2/0

Art.no	Description	Max suture size
104-15566-151	BABY CRILE-WOOD STILLE delicate TC 15 cm 6"	3/0
104-15566-181	CRILE-WOOD STILLE delicate TC jaws 18 cm 7"	3/0
104-15566-201	CRILE-WOOD STILLE delicate TC jaws 20 cm 8"	3/0
104-15566-231	CRILE-WOOD STILLE delicate TC jaws 23 cm 9"	3/0
104-15571	NEW ORLEANS STILLE TC jaws 18 cm 7"	3/0
104-15573-161	RYDER STILLE TC jaws 16 cm 6.25"	3/0
104-15573-181	RYDER STILLE TC jaws 18 cm 7"	3/0
104-15573-201	RYDER STILLE TC jaws 20 cm 8"	3/0
104-15585-161	STILLE DD jaws 16 cm 6.25"	4/0
104-15585-181	STILLE DD jaws 18.5 cm 7.5"	4/0
104-15585-221	STILLE DD jaws 22 cm 8.75"	4/0
104-15585-251	STILLE DD jaws 25 cm 10"	4/0
104-15586	STILLE TC jaws 18 cm 7"	4/0
104-15590-121	OLSEN-HEGAR STILLE TC jaws with scissors 12 cm 4.75"	3/0
104-15590-131	OLSEN-HEGAR STILLE TC jaws with scissors 13.5 cm 5.25"	2/0
104-15590-171	OLSEN-HEGAR STILLE TC jaws with scissors 17 cm 6.75"	0
104-15590-181	OLSEN-HEGAR STILLE TC jaws with scissors 18.5 cm 7.25"	0
104-15621-179	MATHIEU STILLE TC jaws 17 cm 6.75"	1
104-15621-209	MATHIEU STILLE TC jaws 18.5 cm 7.25"	1
104-15665-151	Frimand-STILLE DUO-GRIP Needle holder TC jaws 15 cm 6"	2/0
104-15777	KAYE STILLE with scissors serrated TC jaws 12 cm 4.75"	5/0
104-15785	CONVERSE STILLE TC jaws 10.5 cm 4.25"	4/0

Suture size indicates the largest recommended for each needle holder.

Derf STILLE nålförare | Derf STILLE Needle holder

Needle holder with rather short TC jaws, popular in plastic surgery. Intended for 3/0 suture and finer.



104-15542

104-15542 TC jaws 12 cm 4.75"



Webster STILLE nålförare | Webster STILLE Needle holder

Very delicate needle holder for very fine sutures. Smooth jaws or DD jaws. Intended for 5/0 suture and finer.



104-15545



104-15546

104-15545 Very delicate DD jaws 12 cm 4.75"

104-15546 Very delicate Smooth 12 cm 4.75"

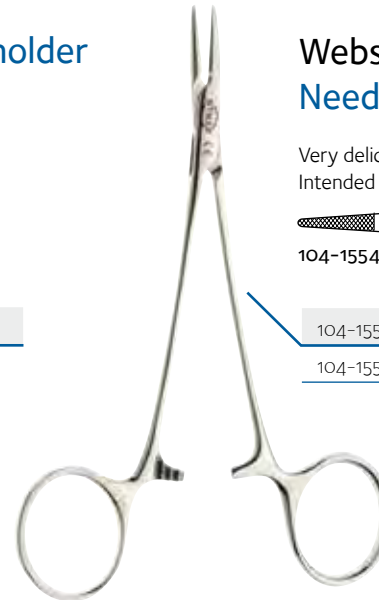

Kilner STILLE nålförare | Kilner STILLE Needle holder

Delicate needleholder with bayonet shaped shanks. TC jaws. Intended for 4/0 suture and finer.

104-15549-131 13 cm 5"



Gillies STILLE nålförare | Gillies STILLE Needle Holder

Needle holder with scissors. Ergonomic design on shanks and finger rings. One rather large ring handle is set at an angle for fitting the top of the thumb. Without ratchets. With or without TC jaws. The scissor part enables suturing and cutting with one instrument. Intended for 2/0 suture and finer.

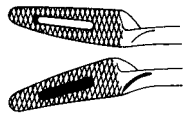

104-15550

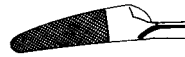

104-15551

104-15550	With scissors		16 cm 6.25"
104-15551	With scissors	TC jaws	16 cm 6.25"



Webster/Kleinert STILLE nålförare | Webster/Kleinert STILLE Needle holder

Delicate needle holder for fine needles. With smooth jaws or TC jaws. The Webster-Kleinert (104-15557) has offset bows for a comfortable grip. Intended for 4/0 suture and finer.

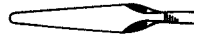

104-15556

104-15557



104-15559

104-15556	Delicate	Smooth	12 cm 4.75"
104-15557	Offset bows	Smooth	12 cm 4.75"
104-15559	Serrated	TC jaws	12 cm 4.75"

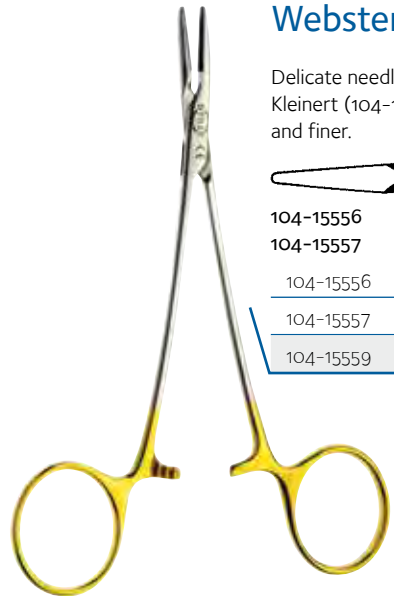

Webster STILLE nålförare | Webster STILLE Needle holder

Delicate needle holder for fine needles. With smooth TC jaws. Intended for 3/0 suture and finer.



104-15558

104-15558	Smooth	TC jaws	12 cm 4.75"
-----------	--------	---------	-------------





Halsey STILLE nålförare | Halsey STILLE Needle Holder

Needle holder with TC jaws used in many procedures. One model with ergonomically designed finger ring for thumb. For slightly larger needles than the Webster needle holder. Intended for 3/0 suture and finer.



104-15560

104-15560	TC jaws	12.5 cm 5"
104-15560-2 Ergonomic	TC jaws	12.5 cm 5"

Mayo-Hegar STILLE nålförare | Mayo-Hegar STILLE Needle holder

Commonly used general purpose needle holder with TC jaws. Intended for 0 suture and finer.



104-15561

104-15561-141	TC jaws	14 cm 5.5"
104-15561-161	TC jaws	16 cm 6.25"
104-15561-181	TC jaws	18 cm 7"
104-15561-201	TC jaws	20 cm 8"
104-15561-251	TC jaws	25 cm 10"



Mayo-Hegar STILLE kraftig nålförare | Mayo-Hegar STILLE Heavy Needle holder

Heavier version of the widely used Mayo-Hegar needle holder, with TC jaws. Intended for 1 suture and finer.

104-15562-161	Heavy Pattern	TC jaws	16 cm 6.25"
104-15562-181	Heavy Pattern	TC jaws	18.5 cm 7.25"
104-15562-201	Heavy Pattern	TC jaws	20.5 cm 8"
104-15562-241	Heavy Pattern	TC jaws	24 cm 9.5"
104-15562-271	Heavy Pattern	TC jaws	27 cm 10.75"
104-15562-301	Heavy Pattern	TC jaws	30.5 cm 12"

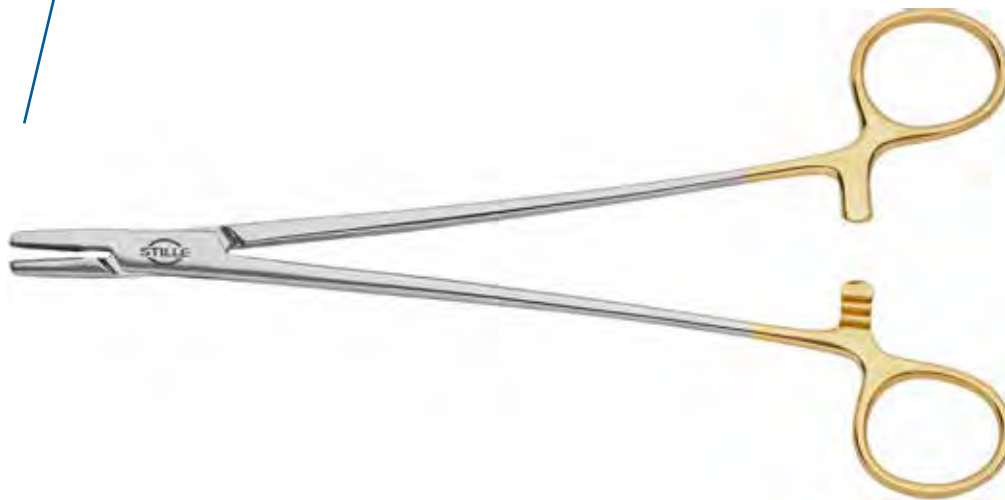

STILLE Crile-Wood nålförare | STILLE Crile-Wood Needle holder

General purpose needle holder with TC jaws. Intended for 2/0 suture and finer.



104-15565

104-15565-151	TC jaws 15 cm 6 in
104-15565-181	TC jaws 18 cm 7 in
104-15565-201	TC jaws 20 cm 8 in
104-15565-231	TC jaws 23 cm 9 in



Crile-Wood STILLE gracil nålförare | Crile-Wood STILLE Delicate Needle holder

Delicate version of the popular Crile-Wood needle holder. With TC jaws. Intended for 3/0 suture and finer.



104-15566

104-15566-151	Delicate	TC jaws	15 cm 6"
104-15566-181	Delicate	TC jaws	18 cm 7"
104-15566-201	Delicate	TC jaws	20 cm 8"
104-15566-231	Delicate	TC jaws	23 cm 9"



STILLE-Frimand DUO-GRIP nålförare | STILLE-Frimand DUO-GRIP Needle holder

Designed in cooperation with Carl-Fredrik Frimand, M.D. Intended for precise use in the palmar grip without the need of grip change during suturing. This new and innovative needle holder reduces the suturing time and tissue manipulation as well as offering better ergonomics for the surgeon. Intended for 2/0 suture and finer.



104-15665-151

104-15665-151	TC jaws	15 cm 6"
---------------	---------	----------



New Orleans STILLE nålförare | New Orleans STILLE Needle holder

Short tapered TC jaws, one jaw straight serrated and the other cross-serrated.
Intended for 3/0 suture and finer.



104-15571

104-15571	TC jaws	18 cm 7"
-----------	---------	----------

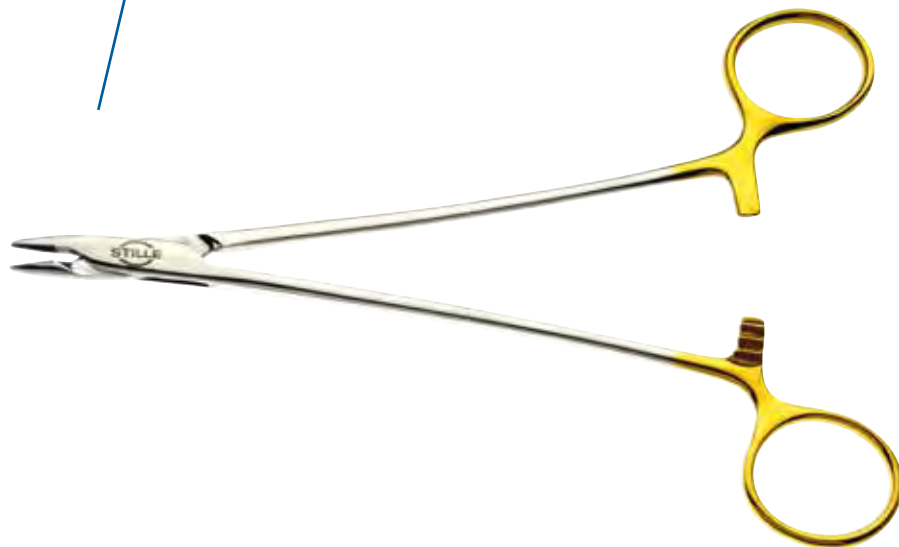

Ryder STILLE nålförare | Ryder STILLE Needle holder

Needle holder with very narrow, non-tapered, serrated TC jaws. Popular in vascular surgery. Intended for 3/0 suture and finer.



104-15573

104-15573-161	TC jaws	16 cm 6.25"
104-15573-181	TC jaws	18 cm 7"
104-15573-201	TC jaws	20 cm 8"



STILLE nålförare | STILLE Needle holder

TC-sprayed delicate jaws. Intended for 4/0 suture and finer.



104-15585

104-15585-161	DD jaws	16 cm 6.25"
104-15585-181	DD jaws	18.5 cm 7.5"
104-15585-221	DD jaws	22 cm 8.75"
104-15585-251	DD jaws	25 cm 10"



STILLE nålförare | STILLE Needle holder

Delicate needle holder with TC jaws. Intended for 4/0 suture and finer.



104-15586

104-15586	TC jaws	18 cm 7"
-----------	---------	----------



Olsen-Hegar STILLE nålförare | Olsen-Hegar STILLE Needle holder

Popular needle holder with scissors for suturing and cutting with the same instrument. Intended for 0 suture and finer. See table "Needle holder in relation to suture size" for suitable suture size for each article code. 3+3 ratchets, 104-15590-171 has 2+2 ratchets.

104-15590-121	Scissors	12 cm 4.75"
104-15590-131	Scissors	13.5 cm 5.25"
104-15590-171	Scissors	17 cm 6.75"
104-15590-181	Scissors	18.5 cm 7.25"



Mathieu STILLE nålförare | Mathieu STILLE Needle holder

Needle holder with straight TC jaws. Plier type handle with ratchets that allows the surgeon to open and close the needle holder rapidly. Intended for 1 suture and finer.



104-15621

104-15621-179	TC jaws	17 cm 6.75"
104-15621-209	TC jaws	18.5 cm 7.25"



Kaye STILLE nålförare | Kaye STILLE Needle holder

Delicate needle holder with short, fine TC jaws and sharp scissors. The scissor part enables suturing and cutting with one instrument. Intended for 5/0 suture and finer.



104-15777

104-15777 Serrated TC jaws 12 cm 4.75"



Converse STILLE nålförare | Converse STILLE Needle holder

Short and delicate needle holder for fine work. With TC jaws. Intended for 4/0 suture and finer.

104-15785 TC jaws 10.5 cm 4.75"



Rapp-STILLE knuthållartång | Rapp-STILLE Knot-holding Forceps

A 13 cm knot-holding forceps with smooth jaws. Ideal instrument to use as a tool for holding the suture knot in narrow areas.



104-15140

104-15140 13 cm 5"



STILLE ståltrådsroterare | STILLE Wire Twisting Forceps

A good tool for twisting steel wires. With TC jaws.

104-15832	TC-inserts	15 cm 6"
104-15835	TC-inserts	18,5 cm 7.25"

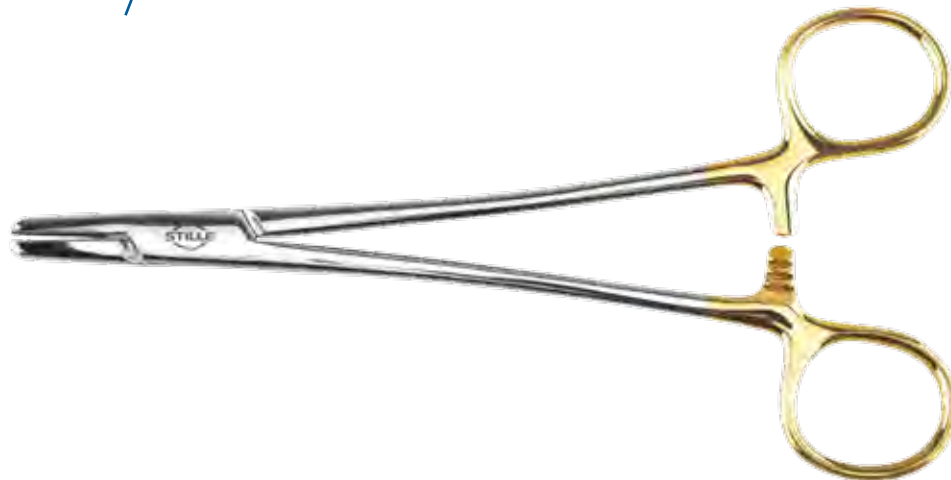

STILLE ståltrådshållare | STILLE Wire Holding Forceps

For holding steel wires. Equipped with double-action joint and TC jaws. The jaws close parallel to secure a firm grip of the wire.

104-15854	Fine	18 cm 7"
104-15855	Medium	18 cm 7"
104-15856	Large	18 cm 7"





MED DUBBELLEDADE BENTÄNGER går det att klippa i benvävnad med bara en hand, mjukt och smidigt. STILLE uppfann den dubbelledade lösningen redan 1872 och sedan dess har såväl våra benavbitare som gougetänger ofta kopierats. Men originalet är alltid bättre än kopian och upplevs av många kirurger som gracilare och enklare att använda än alla andra fabrikat.

Dubbelledade bentänger ökar kraften vid skärytan när man klipper i ben vid maximal utväxling. Bentängernas speciella utformning gör att de inte skymmer sikten i arbetet. De kan användas inom både ortopedi, neurokirurgi och plastikkirurgi.

STILLES bentänger är inte nitade i lederna utan istället monterade med precisionsskruvar. Det gör att de lätt kan tas isär vid slipning och service vilket förlänger instrumentens livslängd avsevärt. Att investera i en original STILLE bentång lönar sig samtidigt som instrumentet erbjuder en unik känsla och precision.

THESE DOUBLE-ACTION BONE RONGEURS allow the surgeon to gently and smoothly cut bone with one hand. STILLE invented this double-action solution as early as 1872 and since then, both our bone cutters and rongeurs have been widely imitated. But the original is always better than the imitation, and are perceived by many surgeons as more graceful and easier to use than any other brand.

Double-action bone rongeurs increase the force at the cutting surface when cutting bone with maximum leverage. The special design means that they do not obstruct the view of the operative area. They can be used for orthopedics, neurosurgery and plastic surgery.

STILLE bone rongeurs are not riveted at the joints, but are assembled using precision screws instead. This means that they can be easily taken apart for sharpening and service, which prolongs the life of the instrument considerably. Choosing original STILLE bone rongeurs is a worthwhile investment and offers a unique feel and ultra precision.



Bentänger | Bone cutters and rongeurs | Knochen & hohlmeisselzangen | Cesioie per ossa & pinze sgorbie | Pinzas cortantes & pinzas-gubias | 骨剪刀および骨鉗子(ロンジュール)

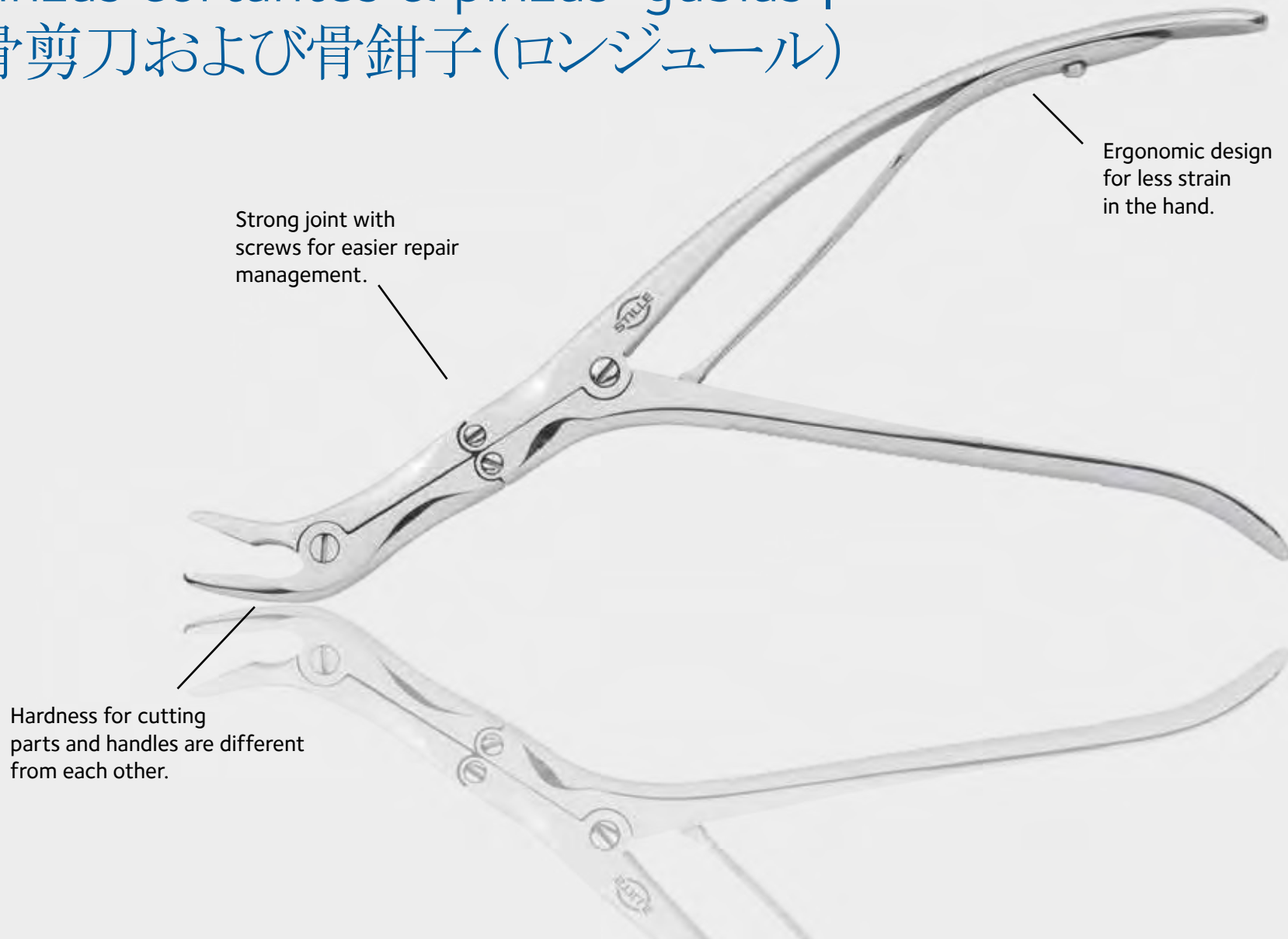

STILLE plattång | STILLE Flat pliers

General purpose flat pliers with cross-serrated jaws.

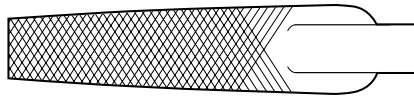

105-16015

105-16015 Cross-serrated 17 cm 6.75"



STILLE extraktionstång | STILLE Extraction plier

Original STILLE double-action joint facilitates removal of pins and wires.



105-16020



105-16020-1

105-16020		19 cm 7,5"
105-16020-1	Narrow jaws	19 cm 7,5"



STILLE benavbitare | STILLE Bone Cutting Forceps

Bone cutting forceps with original STILLE double-action joint.

105-16510 Straight 17 cm 6.75"



STILLE benavbitare | STILLE Bone Cutting Forceps

Delicate bone cutting forceps with original STILLE double-action joint.

105-16512 Angled 18 cm 7"



STILLE benavbitare | STILLE Bone Cutting Forceps

Original STILLE double-action angled bone cutting forceps.

105-16811 Curved 19 cm 7.5"



Beyer STILLE gougetång | Beyer STILLE Bone Rongeur

Nasal rongeur with curved, delicate jaws.



105-17030

105-17030	Curved	17 cm 6.75"
-----------	--------	-------------



Beyer STILLE gougetång | Beyer STILLE Bone Rongeur

Bone rongeur with original STILLE double-action joint and two different jaw widths.



105-17210



105-17211

105-17210	Curved		18 cm 7"
105-17211	Curved	Delicate	18 cm 7"



Zaufal-Jansen STILLE gougetång | Zaufal-Jansen STILLE Bone Rongeur

Bone rongeur with original STILLE double-action joint and wide, curved jaws.



105-17215

105-17215	Curved		17 cm 6.75"
-----------	--------	--	-------------



STILLE gougetång | STILLE Bone Rongeur

Bone rongeurs with STILLE double-action joint and two different jaw widths.



105-17216



105-17217

105-17216		Curved	15 cm 6"
105-17217	Delicate jaws	Curved	15 cm 6"



Ruskin-STILLE gougetång | Ruskin-STILLE Bone Rongeur

Bone rongeur with original STILLE double-action joint and curved jaws.



105-17220

105-17220		Curved	19 cm 7.5"
-----------	--	--------	------------



Luer-STILLE gougetång | Luer-STILLE Bone Rongeur

Bone rongeur with original STILLE double-action joint and strongly curved wide jaws.

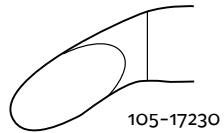

105-17230 Curved 22 cm 8.75"



STILLE gougetång | STILLE Bone Rongeur

Bone rongeur with original STILLE double-action joint and sideways curved jaws.

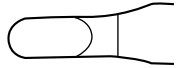

105-17250

105-17250 Curved 22 cm 8.75"

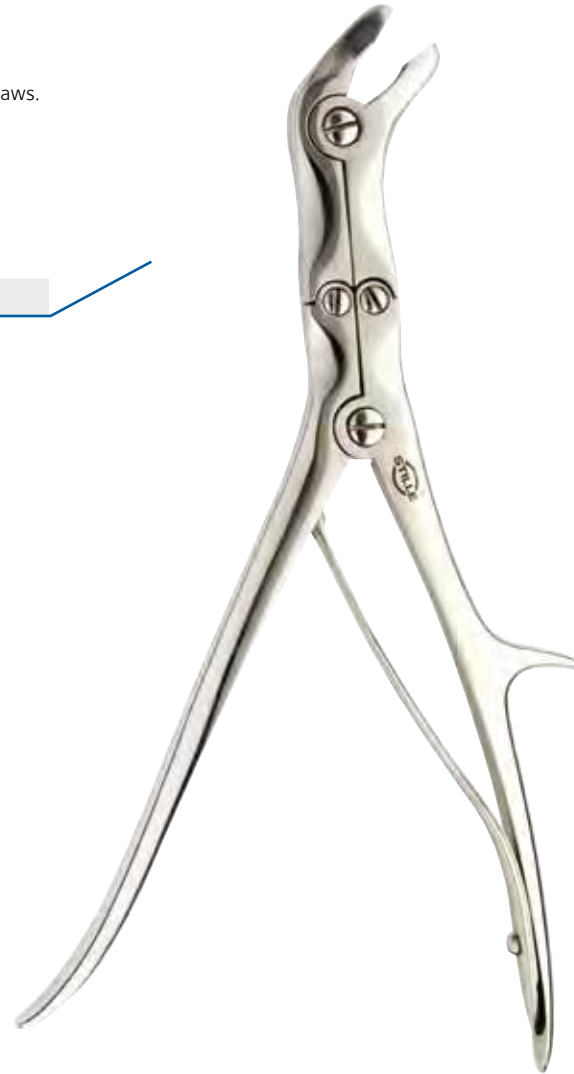

Leksell STILLE gougetång | Leksell STILLE Bone Rongeur

Bone rongeur with original STILLE double-action joint and sideways slightly curved jaws.



105-17260



105-17261

105-17260	Curved	Wide jaws	24 cm 9.5"
105-17261	Curved	Narrow jaws	24 cm 9.5"



Leksell STILLE gougetång | Leksell STILLE Bone Rongeur

Bone rongeur with original STILLE double-action joint and sideways strongly curved jaws.



105-17265



105-17266

105-17265	Curved	Wide jaws	24 cm 9,5"
105-17266	Curved	Narrow jaws	24 cm 9,5"



STILLE gougetång | STILLE Bone Rongeur

Bone rongeur with original STILLE double-action joint and sideways strongly curved jaws in different sizes.

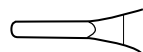

105-17267

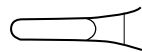

105-17268

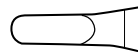

105-17269

105-17267	Curved jaws	2 mm	24 cm 9.5"
105-17268	Curved jaws	3 mm	24 cm 9.5"
105-17269	Curved jaws	4 mm	24 cm 9.5"



Semb STILLE benhållartång | Semb STILLE Bone Holding Forceps

Bone holding forceps with or without locking mechanism.

105-16150	Without lock	19.5 cm 7.75"
105-16152	With lock	19.5 cm 7.75"



STILLE trådavbitare | STILLE Wire Cutter

Single joint wire cutter with TC-inserts. For hard wire up to 0.4 mm and soft wire up to 0.6 mm.

105-16215 TC inserts 12.5 cm 5"



STILLE trådavbitare | STILLE Wire Cutter

Double joint wire cutter with TC-inserts. For hard wire up to 1.7 mm and soft wire up to 2.0 mm.

105-16223 TC inserts 17.5 cm 7"



STILLE trådavbitare | STILLE Wire Cutter

Strong double joint wire cutter with TC-inserts. For hard wire up to 2.5 mm and soft wire up to 2.8 mm.

105-16225

TC inserts 22 cm 8.75"

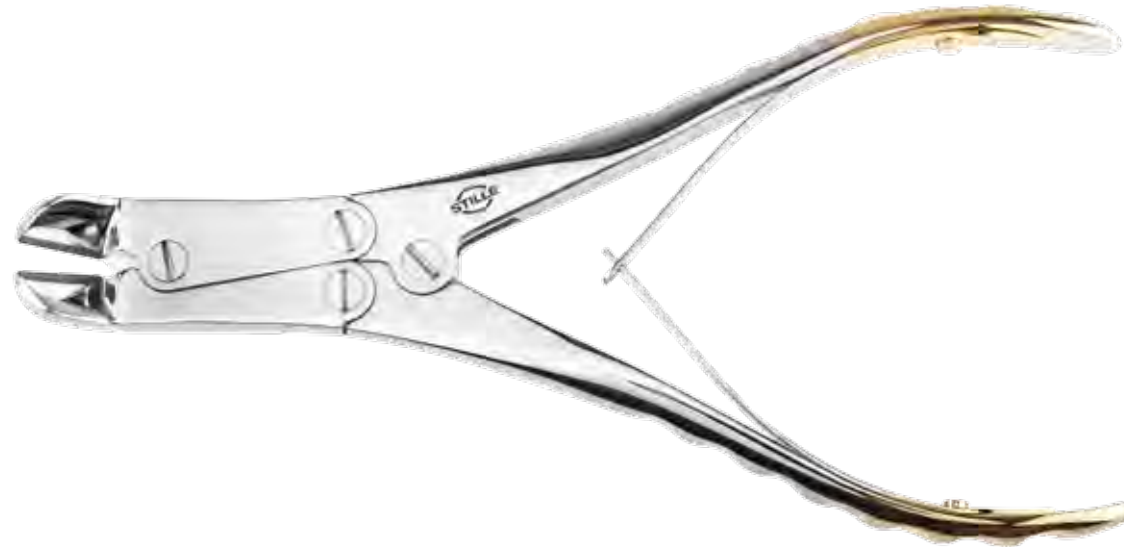

Kerrison STILLE laminektomistans | Kerrison STILLE Laminectomy Punch

The popular Kerrison punches with a unique rubber coated handle for improved ergonomics. No spring between the handles improves the accessibility in cleaning and decreases the risk for getting caught with the gloves. All models come with ejector, 130° up cutting and thin footplate.

105-17642-2	18 cm 7"	2 mm
105-17642-3	18 cm 7"	3 mm
105-17642-4	18 cm 7"	4 mm
105-17642-5	18 cm 7"	5 mm
105-17643-2	20 cm 8"	2 mm
105-17643-3	20 cm 8"	3 mm
105-17643-4	20 cm 8"	4 mm
105-17643-5	20 cm 8"	5 mm
105-17644-2	23 cm 9"	2 mm
105-17644-3	23 cm 9"	3 mm
105-17644-4	23 cm 9"	4 mm
105-17644-5	23 cm 9"	5 mm



**Kerrison STILLE laminektomistans |
Kerrison STILLE Laminectomy Punch**

The same fine Kerrison punches are also available with coating for increased durability.

105-17642-2-C	18 cm 7"	2 mm
105-17642-3-C	18 cm 7"	3 mm
105-17642-4-C	18 cm 7"	4 mm
105-17642-5-C	18 cm 7"	5 mm
105-17643-2-C	20 cm 8"	2 mm
105-17643-3-C	20 cm 8"	3 mm
105-17643-4-C	20 cm 8"	4 mm
105-17643-5-C	20 cm 8"	5 mm
105-17644-2-C	23 cm 9"	2 mm
105-17644-3-C	23 cm 9"	3 mm
105-17644-4-C	23 cm 9"	4 mm
105-17644-5-C	23 cm 9"	5 mm



Cushing STILLE bittång | Cushing STILLE Rongeur

Rongeur for intervertebral discs, with semi-detachable shaft.
Available with or without coating. Jaw size 2x10 mm.

105-13921-18	2x10 mm	18 cm 7"	
105-13921-18-C	2x10 mm	18 cm 7"	Coated

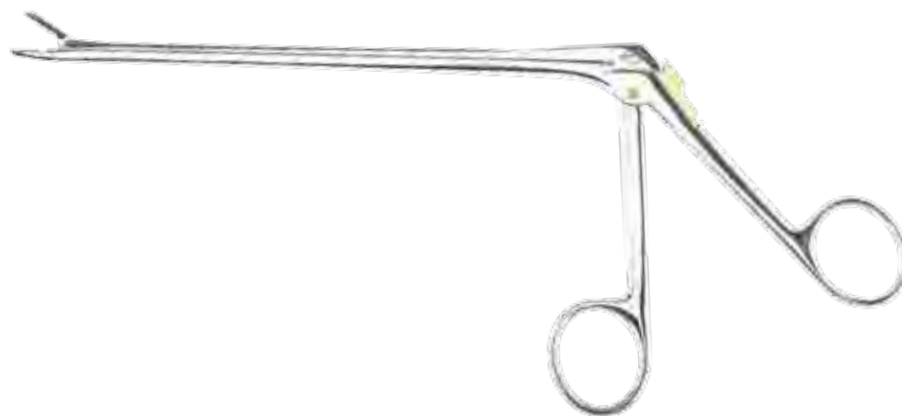

Love-Gruenwald STILLE bittång | Love-Gruenwald STILLE Rongeur

Rongeur for intervertebral discs, with semi-detachable shaft.
Available with or without coating. Jaw size 3x10 mm.

105-13931-18	3x10 mm	18 cm 7"	
105-13931-18-C	3x10 mm	18 cm 7"	Coated



Spurling STILLE bittång | Spurling STILLE Rongeur

Rongeur for intervertebral discs, with semi-detachable shaft. Available with or without coating. Jaw size 4x10 mm.

105-13941-18	4x10 mm	18 cm 7"	
105-13941-18-C	4x10 mm	18 cm 7"	Coated



Caspar STILLE bittång | Caspar STILLE Rongeur

Rongeur for intervertebral discs, with semi-detachable shaft. Available with or without coating. Fenestrated and serrated jaws in three different sizes.

105-13955-18	2x12 mm	18 cm 7"	
105-13955-18-C	2x12 mm	18 cm 7"	Coated
105-13956-18	3x12 mm	18 cm 7"	
105-13956-18-C	3x12 mm	18 cm 7"	Coated
105-13957-18	4x14 mm	18 cm 7"	
105-13957-18-C	4x14 mm	18 cm 7"	Coated





EN KÄRLKLÄMMA MÅSTE GE EXAKT DET TRYCK som krävs för att stoppa en blödning på ett säkert men ändå atraumatiskt sätt. Stänger klämman inte korrekt om kärlet riskerar det att skadas.

Den approximala stängningen av käftarna mot den distala delen fördelar käftarnas tryck jämnt över blodkärlet. Därmed blir trycket så litet som möjligt, men ändå effektivt. En klämma måste även tåla den mekaniska spänning den utsätts för.

Ett annat säkert kännetecken för STILLEs kärklämmare är det öppna boxlåset, vilket minskar risken för att instrumentet ska fastna i vävnad eller kirurgens handskar. Samtidigt förenklas rengöring och sterilisering. Knäppets unika utformning ser till att kärklämmaren hålls stängd i ett säkert läge samtidigt som den är enkel att öppna igen. Knäppena på STILLEs kärklämmare är försedda med flera steg för att möjliggöra korrekt tryck över kärlet.

I sortimentet ingår också ett antal andra klämmare med samma unika STILLE-kvalitet, som t ex fattningstänger, dukklämmor och ringtänger.



A VASCULAR CLAMP MUST PROVIDE THE EXACT PRESSURE required to stop bleeding in a safe and atraumatic way. If the clamp closes improperly the vessel is likely to be damaged.

The closure of the jaws on the distal portion ensures pressure is evenly distributed over the blood vessel. Thus, the pressure is as small as possible while maintaining effectiveness. A clamp must also withstand the mechanical stress it is subjected to.

Another sure characteristic of STILLE's vascular clamps is the open box lock, which reduces the risk of the instrument getting stuck in the tissue or the surgeon's gloves, while simplifying the cleaning and sterilization process. The ratchet's unique design ensures that the instrument stays closed in a safe position while being easy to open. Closures on STILLE vascular clamps are fitted with several steps to allow various degrees of pressure on the vessel.

The range also includes a number of other clamps with the same unique STILLE quality, such as tissue grasping forceps, towel clamps and ring forceps.

Klämmare | Clamps | Klemmen | Pinze | Pinzas | 血管鉗子および組織把持鉗子

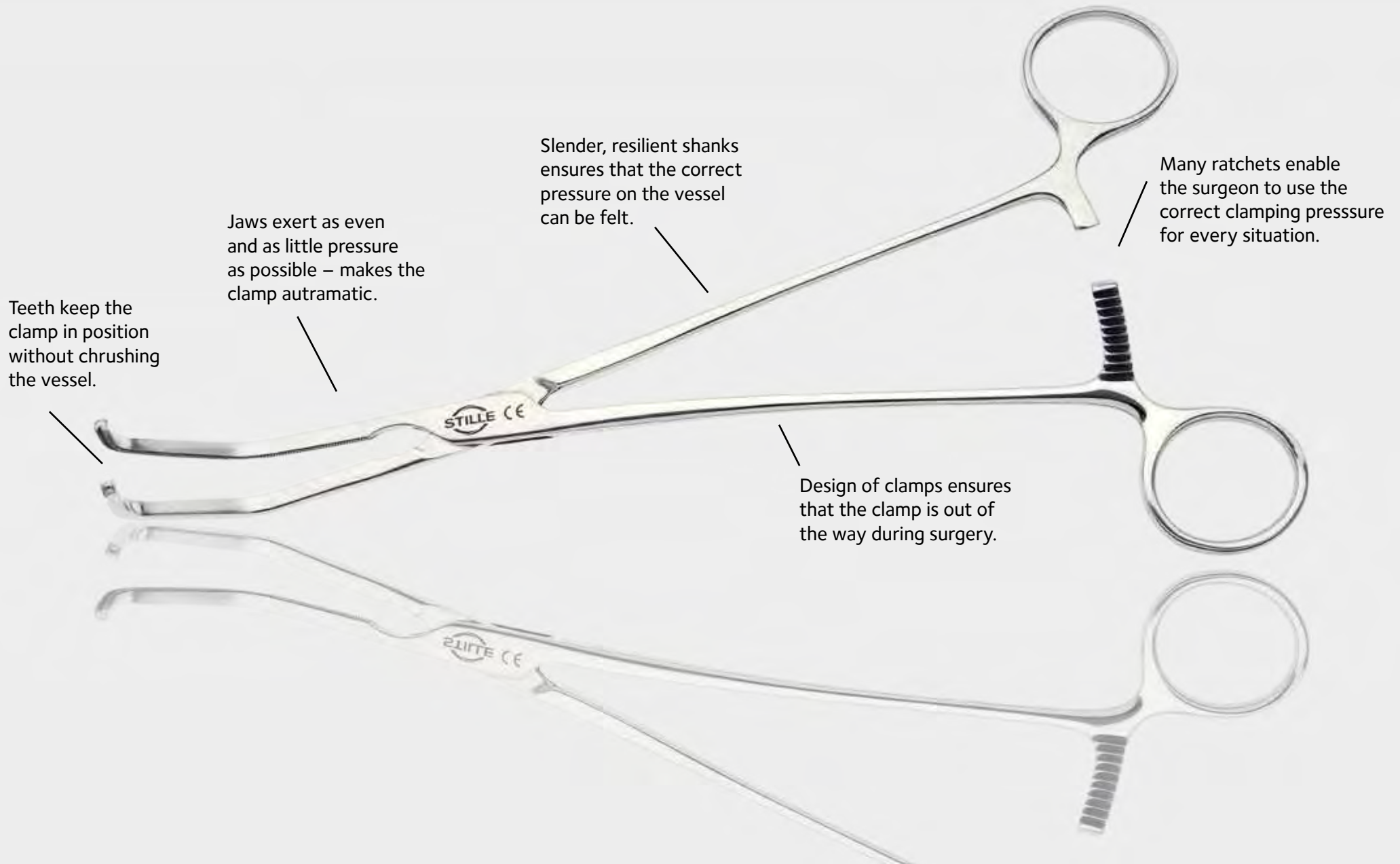

STILLE colonklämmare | STILLE Colon Clamp

Colon clamp with atraumatic DeBakey jaws. Long ratchet for precise adjustment.

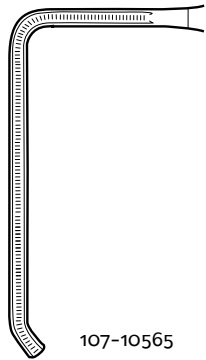

107-10565

107-10565 Atraumatic 5 cm jaws 23.5 cm 9.25"

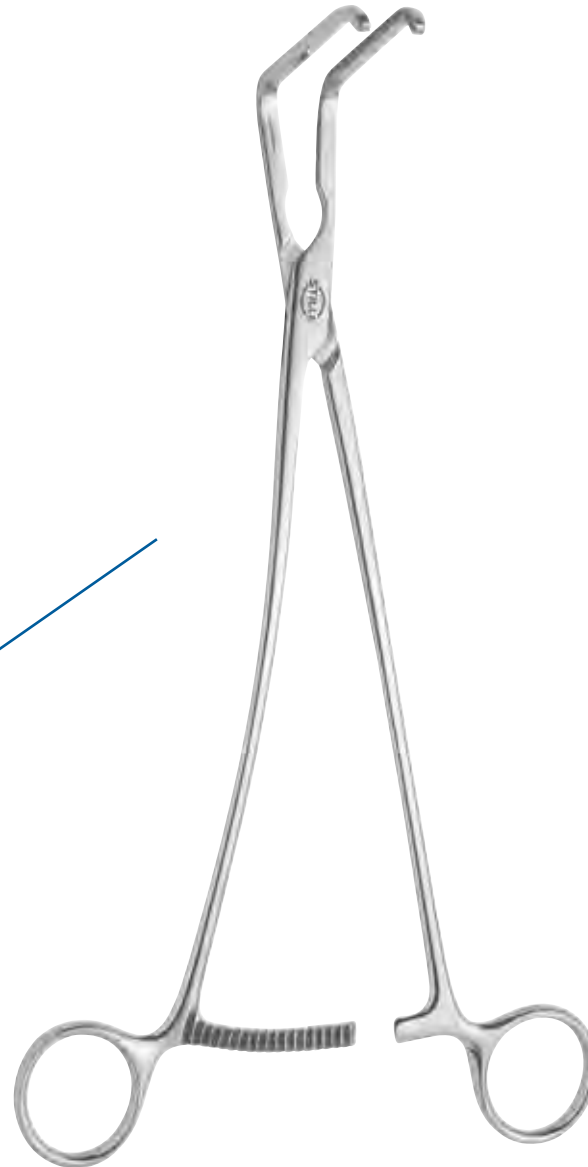

Wikström STILLE galltång | Wikström STILLE Gall Duct Clamp

Gall duct clamp with angled, serrated jaws.

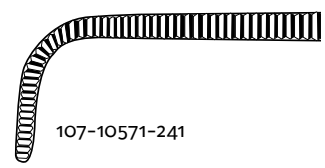

107-10571-241

107-10571-241 Angled 24 cm 9.5"



Uppsala STILLE galltång | Uppsala STILLE Gall Duct Clamp

Gall duct clamp with S-shaped, serrated jaws.

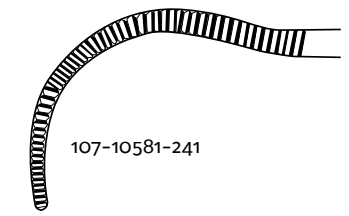

107-10581-241

107-10581-241 S-shaped 24 cm 9.5"



**STILLE mini universalklammare |
STILLE mini Multi-purpose clamp**

Multipurpose vascular mini clamps with spoon shaped atraumatic DeBakey jaws.



107-10655



107-10656

107-10655	Small	20 mm jaws	15.5 cm 6.25"
107-10656	Angled shanks	20 mm jaws	15 cm 6"



**STILLE mini universalklammare |
STILLE mini Multi-purpose clamp**

Multipurpose vascular mini clamps with atraumatic DeBakey jaws.



107-10665



107-10670

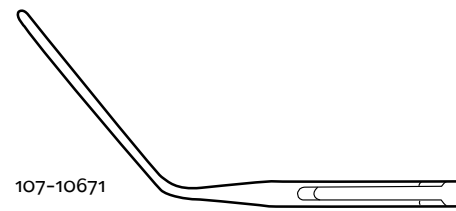

107-10671

107-10665	Straight shanks	25 mm jaws	15.5 cm 6.25"
107-10670	Angled 30°	30 mm jaws	15.5 cm 6.25"
107-10671	Angled 50°	30 mm jaws	15 cm 6"

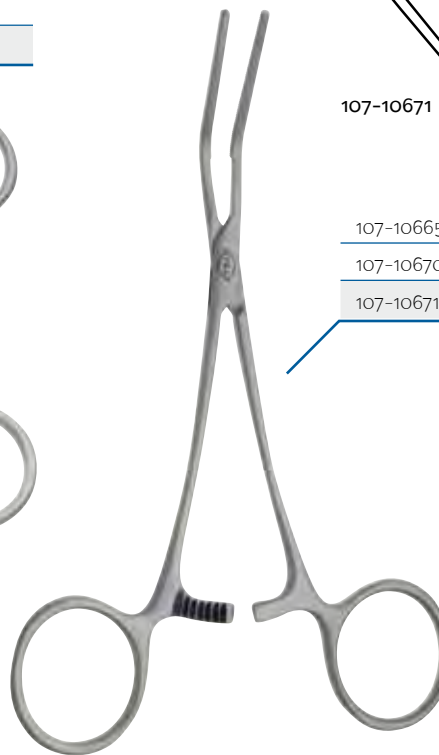

STILLE universalklammare | STILLE
 Multi-purpose clamp

Multi purpose clamps with angled, atraumatic DeBakey jaws.

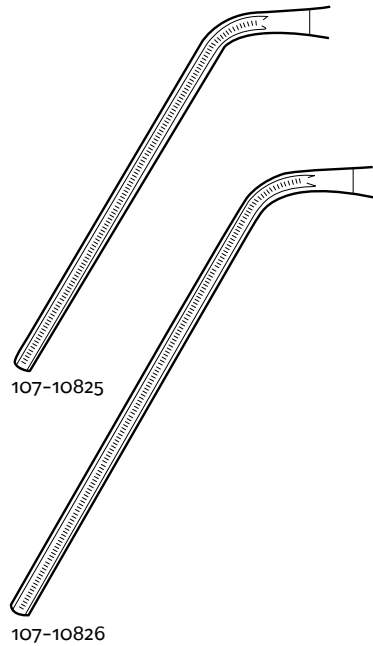

107-10825	Atraumatic	6 cm jaws	23 cm 9"
107-10826	Atraumatic	7.5 cm jaws	22.5 cm 8.75"



STILLE universalklammare | STILLE
Multi-purpose clamp

Multi purpose clamps with angled, atraumatic DeBakey jaws.

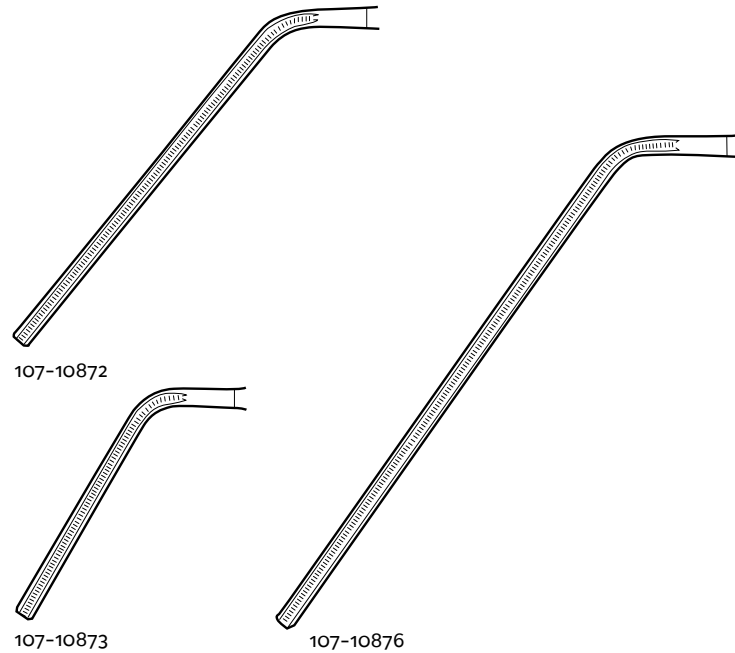

107-10872	Atraumatic	6 cm jaws	18.5 cm 7.25"
107-10873	Atraumatic	3.5 cm jaws	15.5 cm 6.25"
107-10876	Atraumatic	8 cm jaws	20 cm 8"



STILLE mini tangential occlusionsklämmare | STILLE mini Tangential Occlusion Clamp

Tangential occlusion mini clamps with three different jaw sizes.
With atraumatic DeBakey jaws.

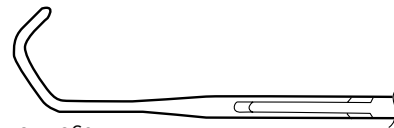

107-10695

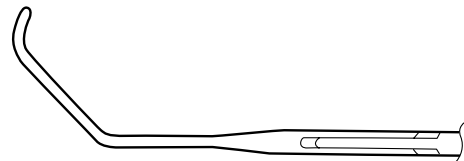

107-10696

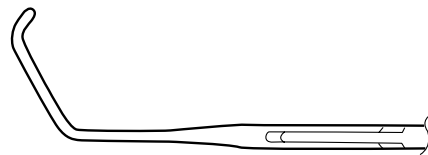

107-10697

107-10695	Small	14 mm jaws	14 cm 5.5"
107-10696	Medium	15 mm jaws	15 cm 6"
107-10697	Large	24 mm jaws	15 cm 6"



Satinsky STILLE tangential occlusionsklämmare
| Satinsky STILLE Tangential Occlusion Clamp

Tangential occlusion clamps with atraumatic DeBakey jaws.

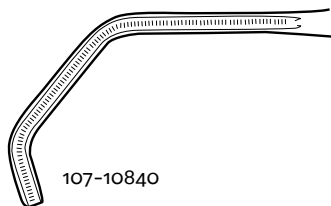

107-10840

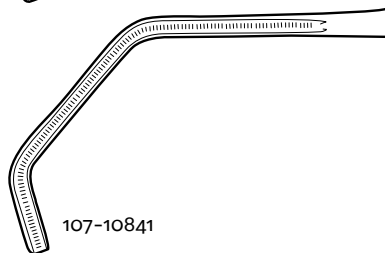

107-10841

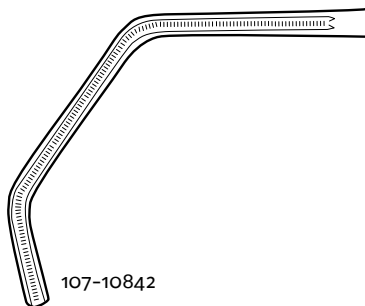

107-10842

107-10840	Atraumatic	Small	22 cm 8.75"
107-10841	Atraumatic	Medium	22.5 cm 9"
107-10842	Atraumatic	Large	23 cm 9"



STILLE perifer kärlklämmare | STILLE Peripheral Vascular Clamp

Peripheral vascular clamp with atraumatic DeBakey jaws.

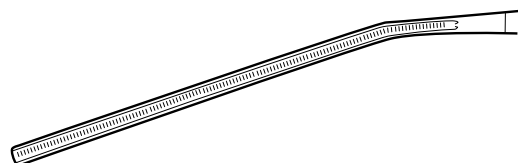

107-10871

107-10871 Atraumatic 6 cm jaws 20 cm 8"

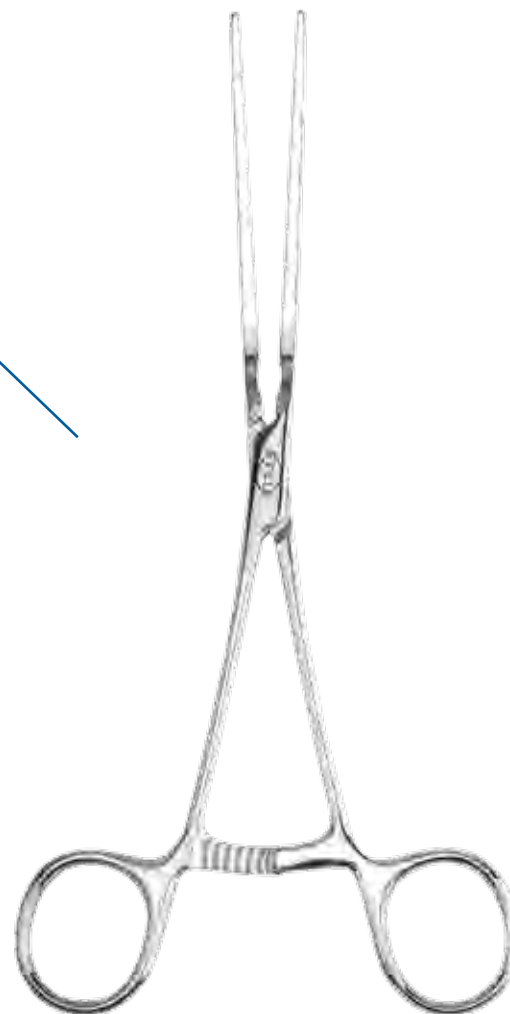

STILLE anastomosklämmare | **STILLE Anastomosis Clamp**

Anastomosis clamps with atraumatic DeBakey jaws.

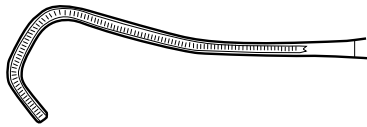

107-10860

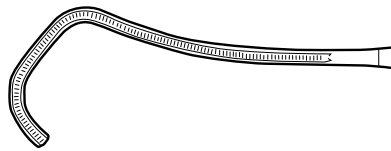

107-10861

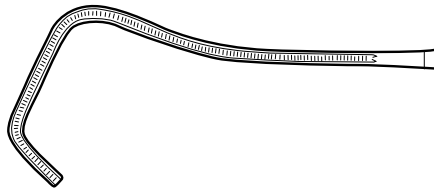

107-10862



107-10860	Atraumatic	1 cm jaws	17,5 cm 7"
107-10861	Atraumatic	1,5 cm jaws	17,5 cm 7"
107-10862	Atraumatic	2 cm jaws	18,5 cm 7.25"

**Lambert-Kay STILLE aorta anastomosklämmare |
Lambert-Kay STILLE Aortic-Anastomosis Clamp**

Aortic anastomosis clamp with atraumatic DeBakey jaws.

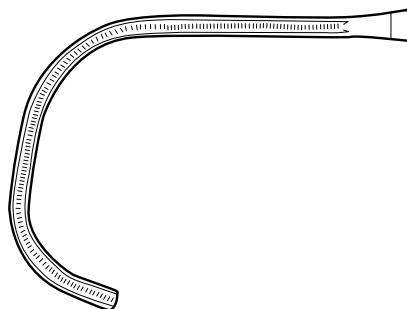

107-10845

107-10845 Atraumatic 22 cm 8.75"



STILLE DeBakey aorta aneurysmklämmare |
STILLE DeBakey Aortic-Aneurysm Clamp

Aortic aneurysm clamp with atraumatic DeBakey jaws.

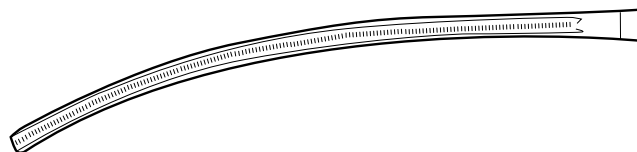

107-10846

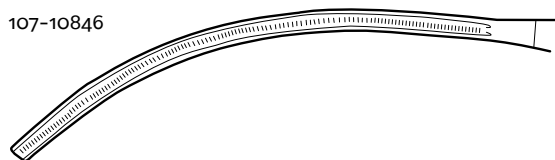

107-10849

107-10846 Atraumatic 8 cm jaws 26 cm 10.25"

107-10849 Atraumatic 7 cm jaws 28 cm 11"



Ericsson-STILLE carotisklämmare | Ericsson-STILLE Carotid Clamp

Carotid clamp with angled atraumatic DeBakey jaws.

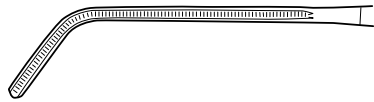

107-10880

107-10880 Atraumatic 17,5 cm 7"



Ericsson-STILLE profunda arteria femoralis klämmare | **Ericsson-STILLE Profunda Femoral Artery Clamps**

Profunda femoral artery clamp with atraumatic DeBakey jaws.

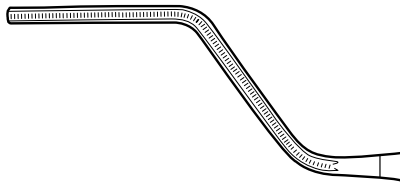

107-10898

107-10898 Atraumatic 18 cm 7"



Backhaus STILLE dukklämmare | Backhaus STILLE Towel Clamps

Towel clamps in two different versions. Sharp/sharp or ball/socket for paper towels.

107-10910	Sharp/Sharp	11 cm 4.25"
107-10912	Ball/socket	13.5 cm 5.25"



**Babcock STILLE fattningstång | Babcock STILLE
Intestinal Grasping Forceps**

Intestinal grasping forceps in two different lengths.

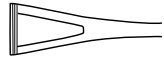

107-12370

107-12370-16	16 cm 6.25"
107-12370-20	20 cm 8"



**Duval STILLE fattningstång | Duval STILLE
Intestinal Grasping Forceps**

Intestinal grasping forceps.

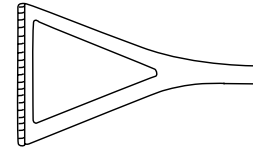

107-12563

107-12563	18 cm 7"
-----------	----------



Allis STILLE fattningstång | Allis STILLE Intestinal Grasping Forceps

Tissue-grasping forceps for secure grip of tissue.



107-13120

107-13120-15	5X6 teeth	15 cm 6"
107-13120-21	5X6 teeth	21 cm 8.25"



Allis STILLE fattningstång | Allis STILLE Intestinal Grasping Forceps

Atraumatic tissue-grasping forceps.

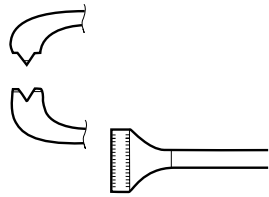

107-13130

107-13130-15 Non-traumatic 15.5 cm 6"

107-13130-19 Non-traumatic 19 cm 7.5"

107-13130-25 Non-traumatic 25 cm 10"

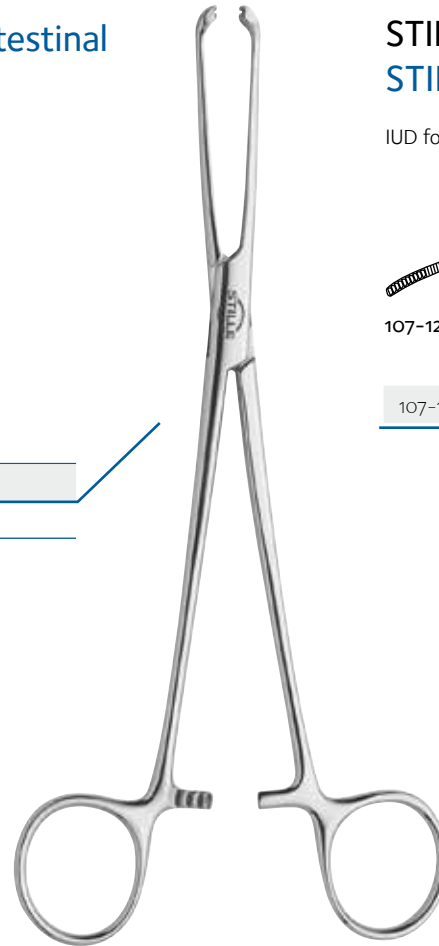

STILLE-Norell spiraltång | STILLE-Norell IUD Forceps

IUD forceps with slightly curved, flattened jaws.

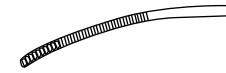

107-12491

107-12491 slightly curved 27 cm 10.5"



Maier STILLE tvättång | Maier STILLE Sponge Holding Forceps

Sponge holding forceps with serrated jaws. Available straight and curved.

107-12478	With ratchet	Straight	26 cm 10.25"
107-12479	With ratchet	Curved	26 cm 10.25"

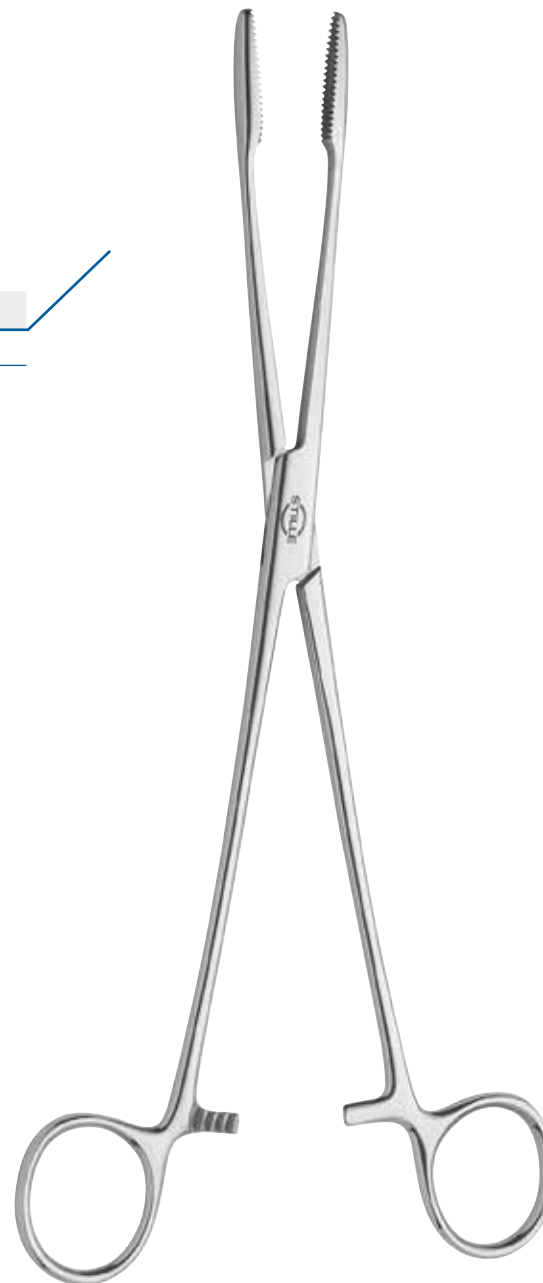

Foerster STILLE ringtång | Foerster STILLE Sponge Holding Forceps

Sponge holding forceps with several different loops and lengths.

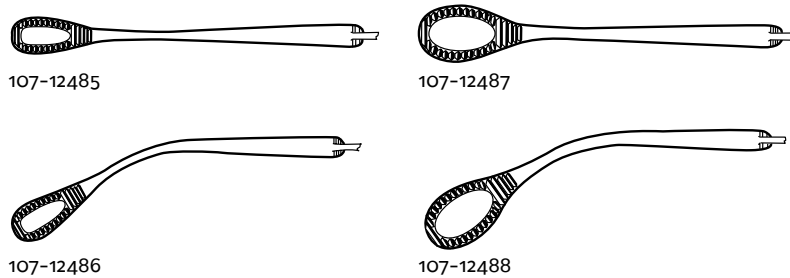

107-12489	Serrated	Straight	18 cm 7"
107-12490	Serrated	Curved	18 cm 7"
107-12485	Serrated	Straight small	24 cm 9.5"
107-12486	Serrated	Curved small	24 cm 9.5"
107-12487	Serrated	Straight large	24 cm 9.5"
107-12488	Serrated	Curved large	24 cm 9.5"



Schroeder STILLE klotång | Schroeder STILLE Tenaculum Forceps

Uterine tenaculum forceps.

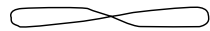

107-13280

107-13280 24 cm 9,5"



STILLE uterusmanipulator | STILLE Uterine Manipulator

Designed to give better control of the uterus for improved visualization during laparoscopic procedures. Slightly rounded probe with a drop-shaped tip for minimized risk of tissue trauma.

107-13290 Probe 60 mm Curved 26.5 cm 10.5"





DET ÄR VIKTIGT ATT HAKEN håller undan vävnaden varligt och atraumatiskt. Därför måste blad, klor och skaft vara så mjukt utformade som möjligt. STILLEs hakar har en design med perfekt rundade kanter och mjuk övergång till klor och blad. Ytan är alltid högglosspolerad för att effektivisera rengöringen och öka livslängden. Handtagen är särskilt utformade för att göra instrumenten bekväma att hantera. Flera modeller har försetts med ergonomiskt utformade handtag.

I sortimentet finns även ett antal självhållande hakar som exempelvis Adsonhakar, Perman bukhakar och revbensspridare.

IS IMPORTANT THAT A RETRACTOR holds the tissue gently and without causing trauma. Therefore, the blade, teeth and handle must be designed and shaped as smoothly as possible. STILLE retractors are designed with perfectly rounded edges and smooth transitions to blade and teeth. The instrument surface is always highly polished, which streamlines cleaning and increases longevity. The handles are specifically designed to ensure the instruments are comfortable to use. Several models have been equipped with ergonomically designed handles.

The range also includes a number of self retaining models such as Adson retractors, Perman abdominal retractors and rib spreaders.

Hakar | Retractors | Wundhaken | Divaricatori | Separadores | 開創器、鉤、レトラクター

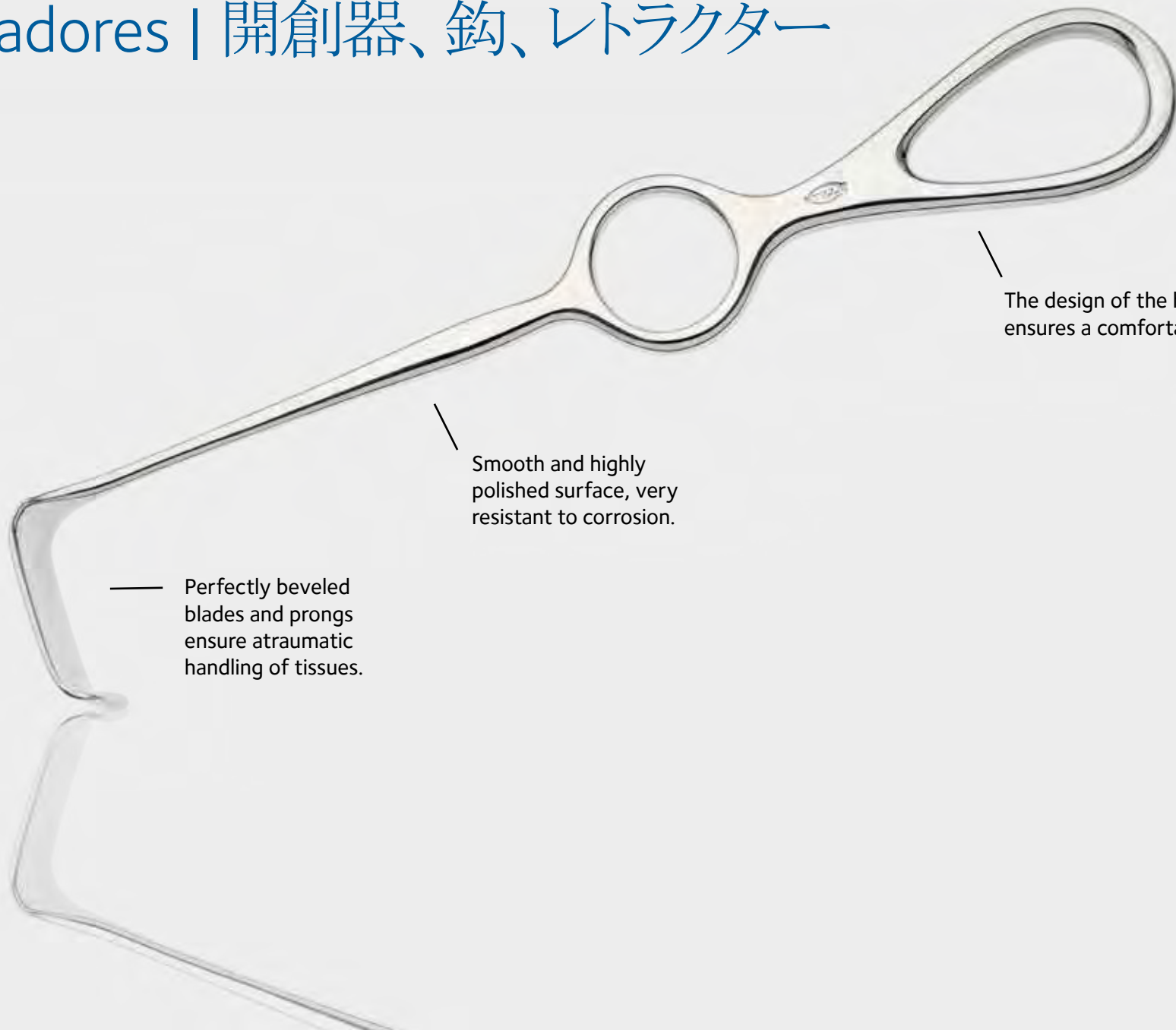

The design of the handle ensures a comfortable grip.

Smooth and highly polished surface, very resistant to corrosion.

Perfectly beveled blades and prongs ensure atraumatic handling of tissues.



Gillies STILLE hudhake | Gillies STILLE Skin Hook

Skin hook with small or large hook on long flat shaft.



108-24110



108-24112

108-24110	Small	19 cm 7.5"
108-24112	Large	19 cm 7.5"



Joseph STILLE hudhake | Joseph STILLE Skin Hook

Skin hook with sharp prongs. Available in five different models. Popular in plastic surgery.



108-25011-1



108-25012-2



108-25012-5



108-25012-10

108-25011-1	Single hook		16 cm 6.25"
108-25012-2	Double hook	2 mm	16 cm 6.25"
108-25012-5	Double hook	5 mm	16 cm 6.25"
108-25012-7	Double hook	7 mm	16 cm 6.25"
108-25012-10	Double hook	10 mm	16 cm 6.25"



Kleinert-Kutz STILLE hudhake | Kleinert-Kutz STILLE Skin Hook

Skin hook with a sharp single prong in three different sizes. Popular in facial and nasal surgery.



108-25031-3 108-25031-5 108-25031-7

108-25031-3	Small	3 mm	16 cm 6.25"
108-25031-5	Medium	5 mm	16 cm 6.25"
108-25031-7	Large	7 mm	16 cm 6.25"

STILLE-AI Hussein lambåhake | STILLE-AI Hussein Flap Retractor

Flap retractor with four or five sharp hooks, for secure handling of larger flaps. Developed in cooperation with Ali Al-Husseiny, M.D.

108-24116	4 sharp hooks	10 cm
108-24117	5 sharp hooks	15 cm





STILLE nervhake | STILLE Nerve Hook

Blunt nerve hook on long flat shaft.



108-24320

108-24320 Slightly curved blunt 22 cm 8.75"



Love STILLE nervhake | Love STILLE Nerve Hook

Nerve root retractor with long flat shaft.

108-26048-7 7 mm 20.5 cm 8"



Moberg STILLE hake | Moberg STILLE Retractor

Retractor with flat handle for facial- and hand surgery.

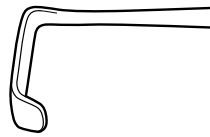

108-24380

108-24380	14x5 mm	17 cm 6.75"
-----------	---------	-------------



Strandell STILLE hake | Strandell STILLE Retractor

Retractor with two different blade lengths. Blades with teeth.



108-24385-8

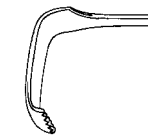

108-24385-15

108-24385-8	With teeth	8x5 mm	19 cm 7.5"
108-24385-15	With teeth	15x5 mm	19 cm 7.5"



STILLE hake | STILLE Retractor

Retractor with one, two or three prongs, sharp or blunt.

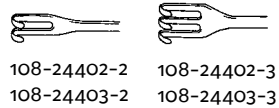
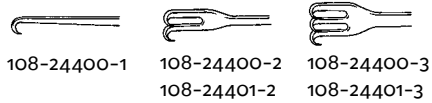

108-24400-1	Sharp	1 prong		18 cm 7"
108-24400-2	Sharp	2 prongs	6 mm	18 cm 7"
108-24400-3	Sharp	3 prongs	9 mm	18 cm 7"
108-24401-2	Ergo	Sharp	2 prongs	18 cm 7"
108-24401-3	Ergo	Sharp	3 prongs	18 cm 7"
108-24402-2	Blunt	2 prongs	6 mm	18 cm 7"
108-24402-3	Blunt	3 prongs	9 mm	18 cm 7"
108-24403-2	Ergo	Blunt	2 prongs	18 cm 7"
108-24403-3	Ergo	Blunt	3 prongs	18 cm 7"



Volkmann STILLE hake | Volkmann STILLE Retractor

Retractor with one to four prongs. Sharp or blunt.

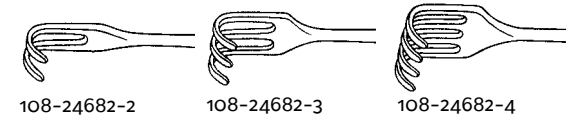
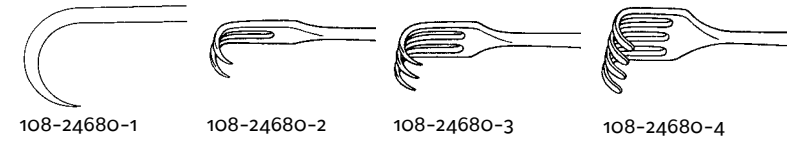

108-24680-1	Sharp	1 prong	Large	21.5 cm 8.5"
108-24680-2	Sharp	2 prongs		22 cm 8.75"
108-24680-3	Sharp	3 prongs		22 cm 8.75"
108-24680-4	Sharp	4 prongs		22 cm 8.75"
108-24682-2	Blunt	2 prongs		22 cm 8.75"
108-24682-3	Blunt	3 prongs		22 cm 8.75"
108-24682-4	Blunt	4 prongs		22 cm 8.75"



Ragnell STILLE hake | Ragnell STILLE Retractor

Double-ended retractor for plastic and reconstructive surgery.

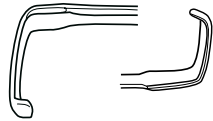

108-24808

108-24808	Double ended	9x3/15x5 mm	15 cm 6"
-----------	--------------	-------------	----------



Langenbeck STILLE hake | Langenbeck STILLE Retractor

General operating retractor with a variety of blade sizes.

108-24812-7	20x7 mm	21 cm 8.25"
108-24814-10	30x10 mm	21 cm 8.25"
108-24814-15	30x15 mm	21 cm 8.25"
108-24814-20	30x20 mm	21 cm 8.25"
108-24816-20	45x20 mm	21 cm 8.25"



Senn STILLE hake | Senn STILLE Retractor

Double-ended retractor for plastic surgery.

108-25940 15x5 mm 3 sharp prongs 15 cm 6"

Aufricht STILLE năshake | Aufricht STILLE Nasal Retractor

Nasal retractor with concave blade.

108-26011 46x10 mm 16 cm 6.25"



Converse STILLE nashake | Converse STILLE Nasal Retractor

Nasal retractor with concave blade. Curved handle for better grip.

108-26015	11.5 cm 4.5"
-----------	--------------



Deaver STILLE hake | Deaver STILLE Retractor

Flexible standard retractor for breast- and facial surgery.

108-26037-19	19 mm	17.5 cm 6.75"
--------------	-------	---------------

108-26037-22	22 mm	20 cm 8"
--------------	-------	----------

108-26037-25	25 mm	30 cm 12"
--------------	-------	-----------



STILLE brösthake | STILLE Breast Retractor

Useful double-sided retractor for breast augmentation. Serrated blades in two different sizes and shapes. Ergonomic handle for maximum comfort.

108-26038 Double-ended black coated handle 23 cm 9"



Desmarres STILLE ögonlockshake | Desmarres STILLE Eye-lid Retractor

For lid retraction in blepharoplasty. Available in four different sizes, with or without insulation.



108-26046-10
108-26846-10

108-26046-12
108-26846-12

108-26046-14
108-26846-14

108-26046-8	8 mm	14 cm 5.5"
108-26046-10	10 mm	14 cm 5.5"
108-26046-12	12 mm	14 cm 5.5"
108-26046-14	14 mm	14 cm 5.5"
108-26846-8	Insulated 8 mm	14 cm 5.5"
108-26846-10	Insulated 10 mm	14 cm 5.5"
108-26846-12	Insulated 12 mm	14 cm 5.5"
108-26846-14	Insulated 14 mm	14 cm 5.5"



Doyen STILLE bukhahe | Doyen STILLE Abdominal Retractor

The famous STILLE-design abdominal retractor with a variety of blade sizes.
The handle is rotated 90° for maximum comfort.

108-24930-20	90x20mm	22 cm 8,75"
108-24930-30	90x30mm	22 cm 8,75"
108-24935-35	110x35mm	22 cm 8,75"
108-24935-40	110x40mm	22 cm 8,75"
108-24935-55	110x55mm	22 cm 8,75"
108-24940-55	120x55 mm	24 cm 9,5"



Perman STILLE bukhahe | Perman STILLE Abdominal Retractor

Self-retaining abdominal retractor. Can be custom designed in various sizes.

108-26865 Depth 65 mm Arm length 18 cm 7"



Kocher STILLE bukspatel | Kocher STILLE Abdominal Spatula

STILLE's classical abdominal spatula, available in three different sizes.
Also used in orthopaedics.

108-23780-25	25 mm	22 cm 8,5"
--------------	-------	------------

108-23780-35	35 mm	22 cm 8,5"
--------------	-------	------------

108-23780-45	45 mm	22 cm 8,5"
--------------	-------	------------



Carlens STILLE Tracheotomihake | Carlens STILLE
Trachea Retractor

Double-ended trachea retractor.

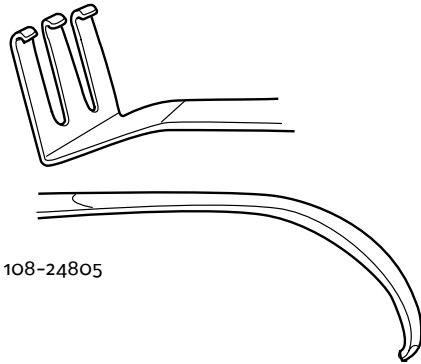

108-24805 Double-ended 22 cm 8.75"



Weitlaner STILLE hake | Weitlaner STILLE Retractor

General purpose self-retaining retractor used in many procedures.

108-26252	2x3 sharp prongs	10.5 cm 4.25"
108-26253	2x3 blunt prongs	10.5 cm 4.25"
108-26254	3x4 sharp prongs	13.5 cm 5.25"
108-26255	3x4 blunt prongs	13.5 cm 5.25"
108-26256	3x4 sharp prongs	16.5 cm 6.5"
108-26257	3x4 blunt prongs	16.5 cm 6.5"



Alm STILLE hake | Alm STILLE Retractor

Self-retaining retractor for fine incisions. Available in two different sizes.

108-26261	4x4 sharp prongs	7 cm 2.75"
108-26262	4x4 sharp prongs	10 cm 4"



Adson STILLE självhållande hake | Adson STILLE
Self Retaining Retractor

Self retaining retractor with sharp prongs. Available in two different sizes.

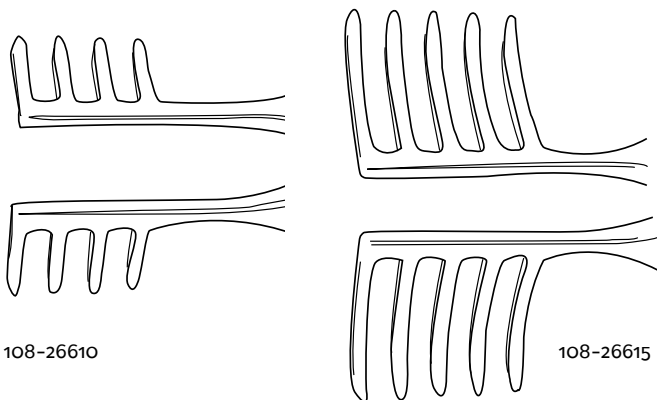

108-26610	4x4 sharp prongs	25 mm	32 cm 12.5"
108-26615	5x5 sharp prongs	45 mm	32 cm 12.5"



Finochietto STILLE revbensspridare | Finochietto STILLE Rib Spreader

Sternum and rib spreader with interchangeable blades.

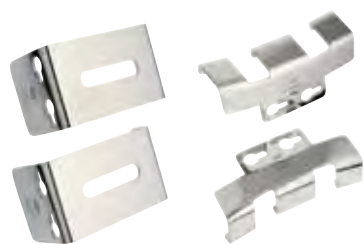

108-26931-80

108-26931-100

108-26931	Self-retaining	with blades 50x50 mm
108-26931-80	Blades	1 pair 80x50 mm
108-26931-100	Blades	1 pair 30x100 mm



Vienna STILLE nässpekulum | Vienna STILLE Nasal Speculum

Nasal speculas in three different sizes.

108-27011-1	24 mm	14 cm 5.5"
108-27011-2	30 mm	14 cm 5.5"
108-27011-3	34 mm	14 cm 5.5"



Cottle STILLE nässpekulum | Cottle STILLE Nasal Speculum

Nasal speculum with locking screw.

108-27021-2	55 mm	14 cm 5.5"
-------------	-------	------------





SKRAPNING, FRILÄGGNING ELLER BORTTAGNING av mjuk och hård vävnad samt andra precisa arbeten kräver ett lätt handlag. Instrumenten måste vara starka men samtidigt följsamma för att undvika skador.

STILLE erbjuder ett sortiment av kyretter, raspatorier, dissektorer och elevatorier av allra högsta kvalitet. Materialet är högglosspolerat rostfritt stål med just de egenskaper som är så viktiga för denna typ av produkter. Stålet är tillräckligt hårt för att hantera hård benvävnad och hålla sig vasst samtidigt som det måste vara följsamt för att inte skada implantat.

I den här produktgruppen ingår också STILLES välkända uteruskyretter. De tillverkas numera med skaft av ohärdat rostfritt stål vilket ger dem de precisa böjbara egenskaperna som behövs. Instrumentet behöver inte beläggas med ett yttskikt av nickel vilket förlänger hållbarheten och ökar patientsäkerheten.

SCRAPING, UNCOVERING OR REMOVAL of soft and hard tissue and other precision work requires a light touch. The instruments must be strong, yet flexible enough to avoid damage.

STILLE offers an assortment of curettes, raspatories, dissectors and elevators of the very highest quality. The material is highly polished stainless steel with precisely the qualities that are so important for these types of instruments. The steel is hard enough to deal with hard bone tissue and to remain sharp, yet flexible enough to avoid damaging implants.

This instrument group also includes STILLE's well known uterine curettes. They are designed with shafts of unhardened stainless steel, which gives them the precise flexibility required. The instruments need not be coated with a surface layer of nickel, which prolongs durability and increases patient safety.



Slevar, Raspatorier, Elevatorier etc. | Currettes,
Raspatories, Elevators etc. | Löffel, Raspatorien,
Elevatorien etc. | Curette, Staccaperiostio,
Elevatori etc. | Cucharillas, Legras, Elevadores etc. |
鋭匙、やすり骨膜起子



Tips stay sharp
for a long time.

High HRC ensures strong
and sharp blades.

Handles designed to
prevent from slipping.

Récamier STILLE uteruskyrett | Récamier STILLE Uterine curette

Malleable uterine curettes in different sizes. With shaft in non-hardened stainless steel, ensures long-time function without any surface coating falling off. Higher patient safety and longer life-time expectancy.

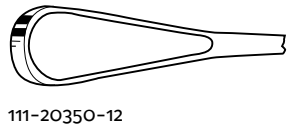
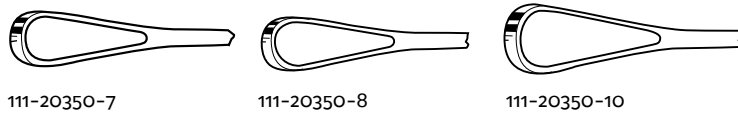
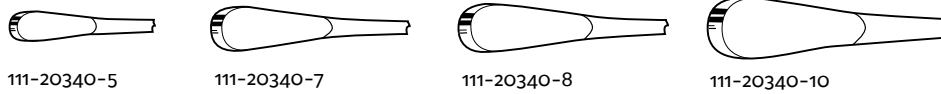

111-20340-5	Sharp	5 mm	30 cm 12"
111-20340-7	Sharp	7 mm	30 cm 12"
111-20340-8	Sharp	8 mm	30 cm 12"
111-20340-10	Sharp	10 mm	30 cm 12"
111-20350-7	Blunt	7 mm	30 cm 12"
111-20350-8	Blunt	8 mm	30 cm 12"
111-20350-10	Blunt	10 mm	30 cm 12"
111-20350-12	Blunt	12 mm	30 cm 12"





STILLE slev | STILLE Bone curette

Oval and sharp bone curettes with widths from 2 mm to 12 mm.

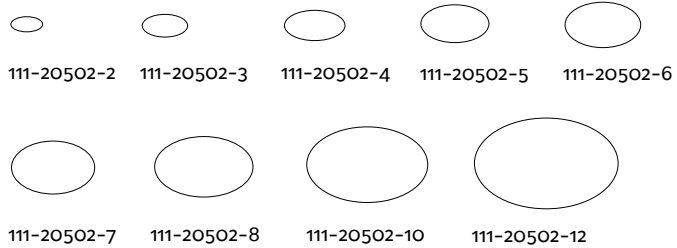

111-20502-2	Sharp oval	2 mm	17.5 cm 7"
111-20502-3	Sharp oval	3 mm	18 cm 7"
111-20502-4	Sharp oval	4 mm	18.5 cm 7.25"
111-20502-5	Sharp oval	5 mm	18.5 cm 7.25"
111-20502-6	Sharp oval	6 mm	18.5 cm 7.25"
111-20502-7	Sharp oval	7 mm	19 cm 7.5"
111-20502-8	Sharp oval	8 mm	19.5 cm 7.75"
111-20502-10	Sharp oval	10 mm	21 cm 8.25"
111-20502-12	Sharp oval	12 mm	21 cm 8.25"



STILLE slev | STILLE Bone curette

Oval and sharp bone curettes with widths from 2 mm to 6 mm. Longer Shaft version.

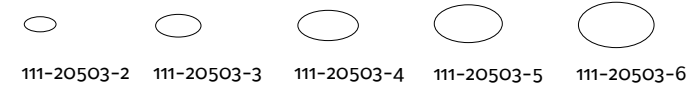

111-20503-2	Sharp oval	2 mm	23 cm 9"
111-20503-3	Sharp oval	3 mm	23 cm 9"
111-20503-4	Sharp oval	4 mm	23 cm 9"
111-20503-5	Sharp oval	5 mm	23 cm 9"
111-20503-6	Sharp oval	6 mm	23 cm 9"



Olivecrona STILLE raspatorium | Olivecrona STILLE Raspatory

Raspatory with sturdy and ergonomic handle. Curved tip.



111-22150

111-22150	Curved	11 mm	17 cm 6.75"
-----------	--------	-------	-------------

Cobb STILLE raspatorium | Cobb STILLE Raspatory

Popular raspatory with round handle. Available with several different tip sizes.

111-22155-10	10 mm	28,5 cm 11.25"
111-22155-13	13 mm	28,5 cm 11.25"
111-22155-19	19 mm	28,5 cm 11.25"
111-22155-25	25 mm	28,5 cm 11.25"





Cottle STILLE raspatorium | Cottle STILLE Raspatory

Commonly used raspatory with a sharp 9 mm rounded tip.

111-22158-9	9 mm	19 cm 7.5"
-------------	------	------------



Lambotte STILLE raspatorium | Lambotte STILLE Raspatory

Raspatory with a wide 23 mm tip.

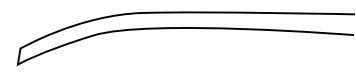

111-22160

111-22160	Curved	23 mm	21 cm 8.25"
-----------	--------	-------	-------------



Wiberg STILLE raspatorium | Wiberg STILLE Raspatory

A straight raspatory in four different sizes.

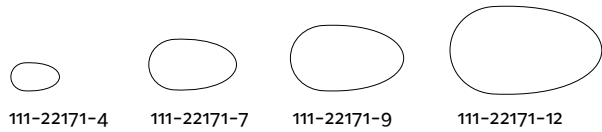

111-22171-4

111-22171-7

111-22171-9

111-22171-12

111-22171-4	Straight	4 mm	17 cm 6.75"
111-22171-7	Straight	7 mm	17 cm 6.75"
111-22171-9	Straight	9 mm	17 cm 6.75"
111-22171-12	Straight	12mm	17 cm 6.75"



Ragnell STILLE raspatorium | Ragnell STILLE Raspatory

Double-ended raspatory with blunt hooks.

111-22350 Blunt hook 17 cm 6.75"



Howarth STILLE näsraspatorium | Howarth STILLE Nasal Raspatory

Double-ended nasal raspatory with sharp hooks.

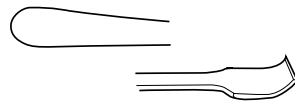

111-22370

111-22370 Double-ended 22 cm 8.75"



Joseph STILLE raspatorium | Joseph STILLE Raspatory

Slightly curved raspatory with flat handle.

111-22385-4 4 mm 17 cm 6.75"

STILLE näsraspatorium | STILLE Nasal Raspatory

Sharp, slightly curved nasal raspatory.

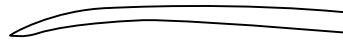

111-22520-4

111-22520-4 Slightly curved Sharp 4 mm 18 cm 7"





Freer STILLE elevatorium | Freer STILLE Elevator

Double-ended elevator sharp/blunt with rounded, delicate handle.

111-22140-4	4.5 mm	19.5 cm 7.75"
111-22140-6	6.5 mm	19.5 cm 7.75"



STILLE näselevatorium | STILLE Nasal Elevator

Blunt nasal elevator.



111-22522-4

111-22522-4	Slightly curved blunt	4 mm	18 cm 7"
-------------	-----------------------	------	----------



Cottle STILLE septum elevator | Cottle
STILLE Septum Elevator

Double-ended fine elevator with graduated shafts.

111-22532	Graduated	3.3/3.7 mm	23 cm 9"
-----------	-----------	------------	----------



Langenbeck STILLE elevator | Langenbeck
STILLE Elevator

Sturdy elevator mainly used in orthopaedics. Available in two sizes.

111-22550-8	8 mm	19.5 cm 7.75"
111-22550-10	10 mm	19.5 cm 7.75"



**Mini-Hohmann STILLE elevatorium |
Mini-Hohmann STILLE Elevator**

Finer version of the Hohmann elevator. Used in foot surgery.

111-22565-6	Bone lever	6 mm	16 cm 6.25"
111-22565-8	Bone lever	8 mm	16 cm 6.25"



**Hohmann STILLE elevatorium | Hohmann STILLE
Elevator**

General utility bone lever for orthopaedic surgery.

111-22567-9	Rounded	9 mm	22 cm 8.75"
111-22568-18	Rounded	18 mm	24 cm 9.5"
111-22569-18	Flat	18 mm	25.5 cm 10"
111-22569-24	Flat	24 mm	26 cm 10.25"



STILLE elevatorium | STILLE Elevator

Standard bone lever in two different sizes.

111-22563-3	3 mm	14.5 cm 5.75"
111-22563-6	6 mm	14.5 cm 5.75"



Stolte STILLE tonsillelevatorium | Stolte STILLE Tonsil Elevator

Curved double-ended tonsil elevator.



111-22635

111-22635	Double-ended	20 cm 8"
-----------	--------------	----------

STILLE dissektor | STILLE Dissector

Double-ended dissector in several different models.

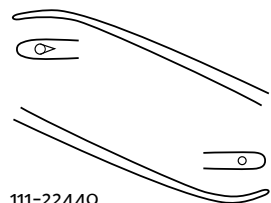

111-22440

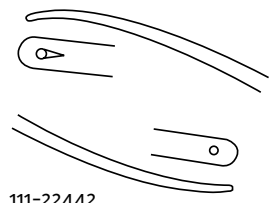

111-22442

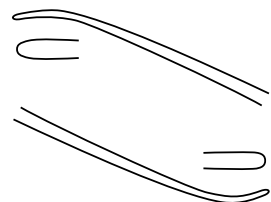

111-22440

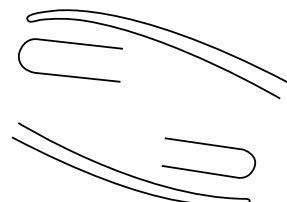

111-22442

111-22440-18	Fine with hole	18 cm 7"
111-22440-24	Fine with hole	24 cm 9.5"
111-22442-19	Coarse with hole	19.5 cm 7.75"
111-22442-24	Coarse with hole	24 cm 9.5"
111-22444	Fine without hole	24.5 cm 9.75"
111-22446	Coarse without hole	24.5 cm 9.5"



Fomon STILLE rasp | Fomon STILLE Rasp

Double-ended rasp with TC-inserts for better durability. Low profile for better access in narrow areas.

111-22860	TC-inserts 1&2	21,5 cm 8,5"
111-22861	TC-inserts 3&4	21,5 cm 8,5"
111-22862	TC-inserts 5&6	21,5 cm 8,5"
111-22863	TC-inserts 7&8	21,5 cm 8,5"





OSTEOTOMER, MEJSLAR, GOUGEMEJSLAR och andra beninstrument från STILLE tillverkas i ett härdat kvalitetsstål med särskilt hög hårdhet för att undvika brytskador eller böjningar. Hårdheten ökar tåligheten mot slitage och stålets seghet avgör hur väl det står emot stora påfrestningar under lång tid.

Det är valet av material med precis rätt hårdhet (HRC-värde) i kombination med tillverkningsmetod som ger instrumentet dess unika skäregenskaper. Eggen är lagd i en perfekt vinkel för maximal skärprestanda. Spetsen är hård nog för att den inte ska fastna i benet. Samtidigt är den mjuk nog för att ge med sig i kontakt med implantat.

Specialslipningen gör att instrumenten förblir vassa under en längre tid innan de behöver slipas om. Handtagen är ergonomiskt utformade för ett handfast grepp. STILLE var först i världen med att tillverka osteotomer och instrumenten har genom åren blivit kända för sina unika egenskaper. Den klassiska STILLE-osteotomen är idag ett begrepp över hela världen.

OSTEOTOMES, CHISELS, MALLETS and other bone instruments from STILLE are made of high quality hardened steel, with particularly high strength to avoid breakage or bending. The hardness increases resistance to wear and the toughness of the steel determines how well the instrument can withstand great strain for long periods of time.

The choice of material with just the right hardness value (HRC) in combination with the manufacturing method provides the instrument with its unique cutting properties. The edges are placed at the perfect angle for maximum cutting performance. The tip is stiff enough so that it will not get caught in the bone, and soft enough to give way when in contact with implants.

Special sharpening techniques allow the instruments to remain sharp for extended periods before they need to be resharpened. The handles are ergonomically designed for a firm and comfortable grip. STILLE was the first in the world to manufacture osteotomes and over the years the instruments have become known for their unique properties. The classic STILLE osteotome is known the world over.



Osteotomer, mejslar etc. | Osteotomes, Chisels etc. |
Osteotome, Flachmeissel etc. | Osteotomi, Scalpelli etc. |
Escoplos, Cinceles etc. | 両刃のみ 片刃のみ



High HRC ensures that the instruments stay sharp.

Handle designed to ensure perfect grip and ergonomomy.

Highest quality steel and hardening for maximum life expectancy.

Special tip grinding for maximum cutting performance.

STILLE osteotom | STILLE Osteotome

The famous STILLE original osteotome, available in 5 different sizes.

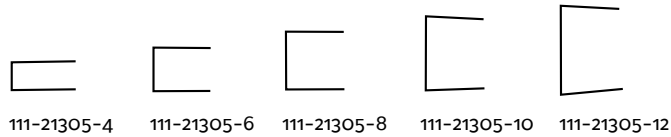

111-21305-4	4 mm	21 cm 8.25"
111-21305-6	6 mm	21 cm 8.25"
111-21305-8	8 mm	21 cm 8.25"
111-21305-10	10 mm	21 cm 8.25"
111-21305-12	12 mm	21 cm 8.25"



STILLE osteotom | STILLE Osteotome

Delicate osteotome with cross-serrated head. Available in 5 different sizes.

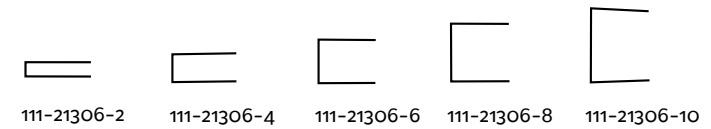

111-21306-2	2 mm	16.5 cm 6.6"
111-21306-4	4 mm	16.5 cm 6.5"
111-21306-6	6 mm	16.5 cm 6.5"
111-21306-8	8 mm	16.5 cm 6.5"
111-21306-10	10 mm	16.5 cm 6.5"





STILLE osteotom | STILLE Osteotome

Osteotome in 5 different sizes. Slightly thicker blade than the STILLE-Kaye osteotome.

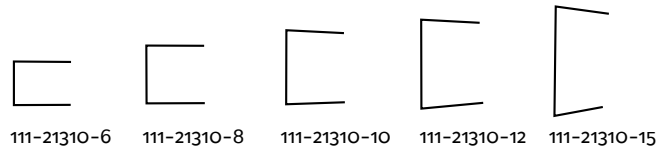

111-21310-6	6 mm	16,5 cm 6,5"
111-21310-8	8 mm	16,5 cm 6,5"
111-21310-10	10 mm	16,5 cm 6,5"
111-21310-12	12 mm	16,5 cm 6,5"
111-21310-15	15 mm	16,5 cm 6,5"



STILLE osteotom | STILLE Osteotome

Osteotome available in 6 different sizes.

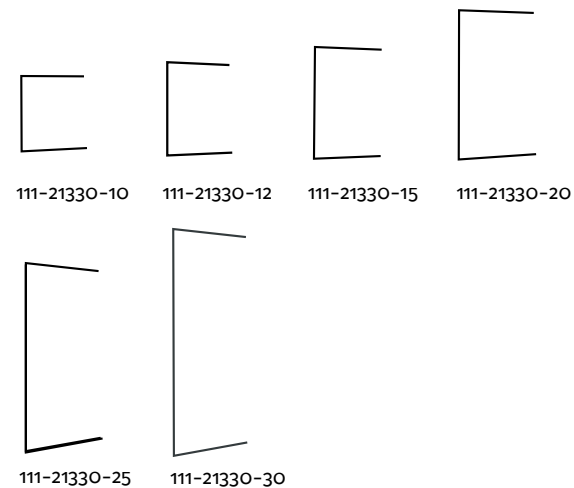

111-21330-10	10 mm	21 cm 8,25"
111-21330-12	12 mm	21 cm 8,25"
111-21330-15	15 mm	21 cm 8,25"
111-21330-20	20 mm	21 cm 8,25"
111-21330-25	25 mm	21 cm 8,25"
111-21330-30	30 mm	21 cm 8,25"



Lambotte STILLE osteotom | Lambotte STILLE Osteotome

Straight osteotome available in 6 different sizes.

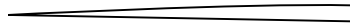

111-21441

111-21441-7	Straight	7 mm	23 cm 9"
111-21441-15	Straight	15 mm	23 cm 9"
111-21441-20	Straight	20 mm	23 cm 9"
111-21441-25	Straight	25 mm	23 cm 9"
111-21441-30	Straight	30 mm	23 cm 9"
111-21441-40	Straight	40 mm	23 cm 9"



Lambotte STILLE osteotom | Lambotte STILLE Osteotome

Curved version of the Lambotte osteotome available in 4 different sizes.



111-21442

111-21442-7	Curved	7 mm	23 cm 9"
111-21442-15	Curved	15 mm	23 cm 9"
111-21442-20	Curved	20 mm	23 cm 9"
111-21442-25	Curved	25 mm	23 cm 9"



Lambotte STILLE miniosteotom | Lambotte STILLE Mini Osteotome

Delicate mini osteotome in 11 different sizes.

111-21450

111-21450-2	Straight	2 mm	12.5 cm 5"
111-21450-3	Straight	3 mm	12.5 cm 5"
111-21450-4	Straight	4 mm	12.5 cm 5"
111-21450-5	Straight	5 mm	12.5 cm 5"
111-21450-6	Straight	6 mm	12.5 cm 5"
111-21450-7	Straight	7 mm	12.5 cm 5"
111-21450-8	Straight	8 mm	12.5 cm 5"
111-21450-9	Straight	9 mm	12.5 cm 5"
111-21450-10	Straight	10 mm	12.5 cm 5"
111-21450-11	Straight	11 mm	12.5 cm 5"
111-21450-12	Straight	12 mm	12.5 cm 5"



STILLE handosteotom | STILLE Hand Osteotome

Delicate osteotome with phenolic handle. Intended for hand surgery, but also useful in other fine orthopaedic work.

111-21456-2	2 mm	16cm 6.25"
111-21456-4	4 mm	16cm 6.25"
111-21456-6	6 mm	16cm 6.25"
111-21456-8	8 mm	16cm 6.25"
111-21456-10	10 mm	16cm 6.25"
111-21456-12	12 mm	16cm 6.25"



Lexer STILLE osteotom | Lexer STILLE Osteotome

Osteotome with phenolic handle.

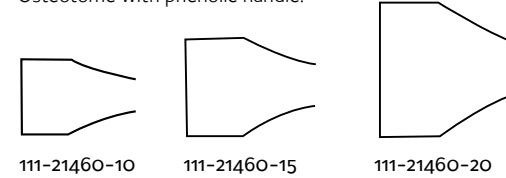

111-21460-10	10 mm	21 cm 8.25"
111-21460-15	15 mm	21 cm 8.25"
111-21460-20	20 mm	21 cm 8.25"



Neivert STILLE osteotom | Neivert STILLE Osteotome

Delicate single-guarded osteotome for lateral osteotomy in rhinoplasty.

111-21501-1	Curved left	20 cm 8"
111-21501-2	Curved right	20 cm 8"
111-21501-3	Straight	20 cm 8"



Cinelli STILLE osteotom | Cinelli STILLE Osteotome

Double-guarded osteotome for hump removal.

111-21517-10	10 mm	16 cm 6.25"
111-21517-12	12 mm	16 cm 6.25"
111-21517-14	14 mm	16 cm 6.25"

Cottle STILLE osteotom | Cottle STILLE Osteotome

Graduated fine osteotome in five different sizes.

111-21477-4	4 mm	18 cm 7"
111-21477-6	6 mm	18 cm 7"
111-21477-8	8 mm	18 cm 7"
111-21477-10	10 mm	18 cm 7"
111-21477-12	12 mm	18 cm 7"



STILLE mejsel | STILLE Chisel

Original STILLE-design chisel in five different sizes from 6 mm to 15 mm.

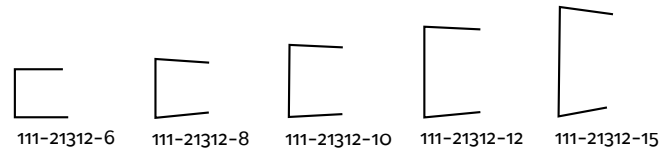

111-21312-6	6 mm	16.5 cm 6,5"
111-21312-8	8 mm	16.5 cm 6,5"
111-21312-10	10 mm	16.5 cm 6,5"
111-21312-12	12 mm	16.5 cm 6,5"
111-21312-15	15 mm	16.5 cm 6,5"



STILLE gougemejsel | STILLE Gouge

Original STILLE gouge. Available in five different sizes from 6 mm to 15 mm.

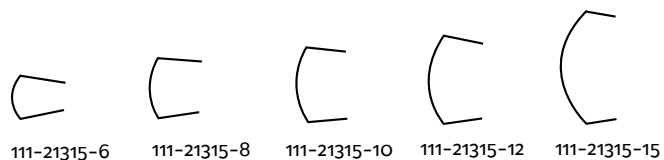

111-21315-6	6 mm	16.5 cm 6.5"
111-21315-8	8 mm	16.5 cm 6.5"
111-21315-10	10 mm	16.5 cm 6.5"
111-21315-12	12 mm	16.5 cm 6.5"
111-21315-15	15 mm	16.5 cm 6.5"



STILLE gougemejsel | STILLE Gouge

Original STILLE gouge. Available in four different sizes from 10 mm to 20 mm.

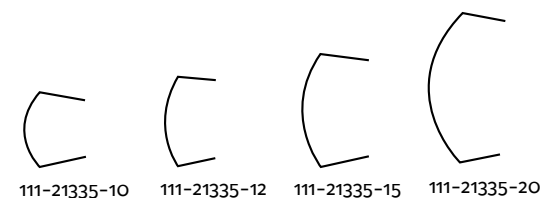

111-21335-10	10 mm	21 cm 8.25"
111-21335-12	12 mm	21 cm 8.25"
111-21335-15	15 mm	21 cm 8.25"
111-21335-20	20 mm	21 cm 8.25"



STILLE pryl | STILLE Awl

Awl with phenolic handle.



STILLE hammare | STILLE Mallet

Stainless steel mallet.

111-21820 200 g 7 oz 21.5 cm 8.5"





STILLE hammare | STILLE Mallet

Mallet with stainless steel head, phenolic handle and interchangeable teflon insert.

111-21825	Mallet	145 g, 7 oz	17 cm 6.75"
111-21825-5	Spare Teflon insert		

STILLE hammare | STILLE Mallet

Mallet with interchangeable plastic head and stainless steel handle.

111-21920	Mallet	245 g, 8.5 oz	24 cm 9.5"
111-21920-5	Spare Plastic head		





DE MEST KOMPLICERADE OPERATIONERNA inom mikrokirurgi kräver högsta precision ända in i minsta detalj. STILLES mikroinstrument är handgjorda av skickliga instrumentmakare och erbjuder perfekt precision och balans.

Sortimentet är i första hand inriktat mot plastikkirurgi och hjärta/-kärlkirurgi. Saxar, pincetter och nålförare finns i flera olika längder och utföranden för att passa alla kirurgers unika önskemål. De svarta eller blåa handtagen indikerar att instrumentet är ett äkta STILLE-instrument.

THE MOST COMPLEX MICROSURGICAL PROCEDURES require precision down to the finest detail. STILLE micro instruments are hand-made by skilled craftsman and provide perfect precision and balance.

The instrument range is primarily focused on plastic surgery and cardio/-vascular surgical procedures. Scissors, forceps and needle holders are available in various lengths and designs to suit any surgeon's unique requirements. The black or blue handles indicate that the instrument is an authentic STILLE design.

Mikroinstrument | Micro instruments | Mikro-instrumente | Strumenti per microchirurgia | Instrumentos para microcirugia | マイクロ器具

The satin finished surface guarantees freedom from glare. The surgeon's eyes do not become tired even during long operations.

Anatomically adapted to the surgeon's hand.

Grooved handle in order to reduce the weight of the instrument.

All edges, the spring unit, pivot and the grip are designed so that gloves cannot be damaged.

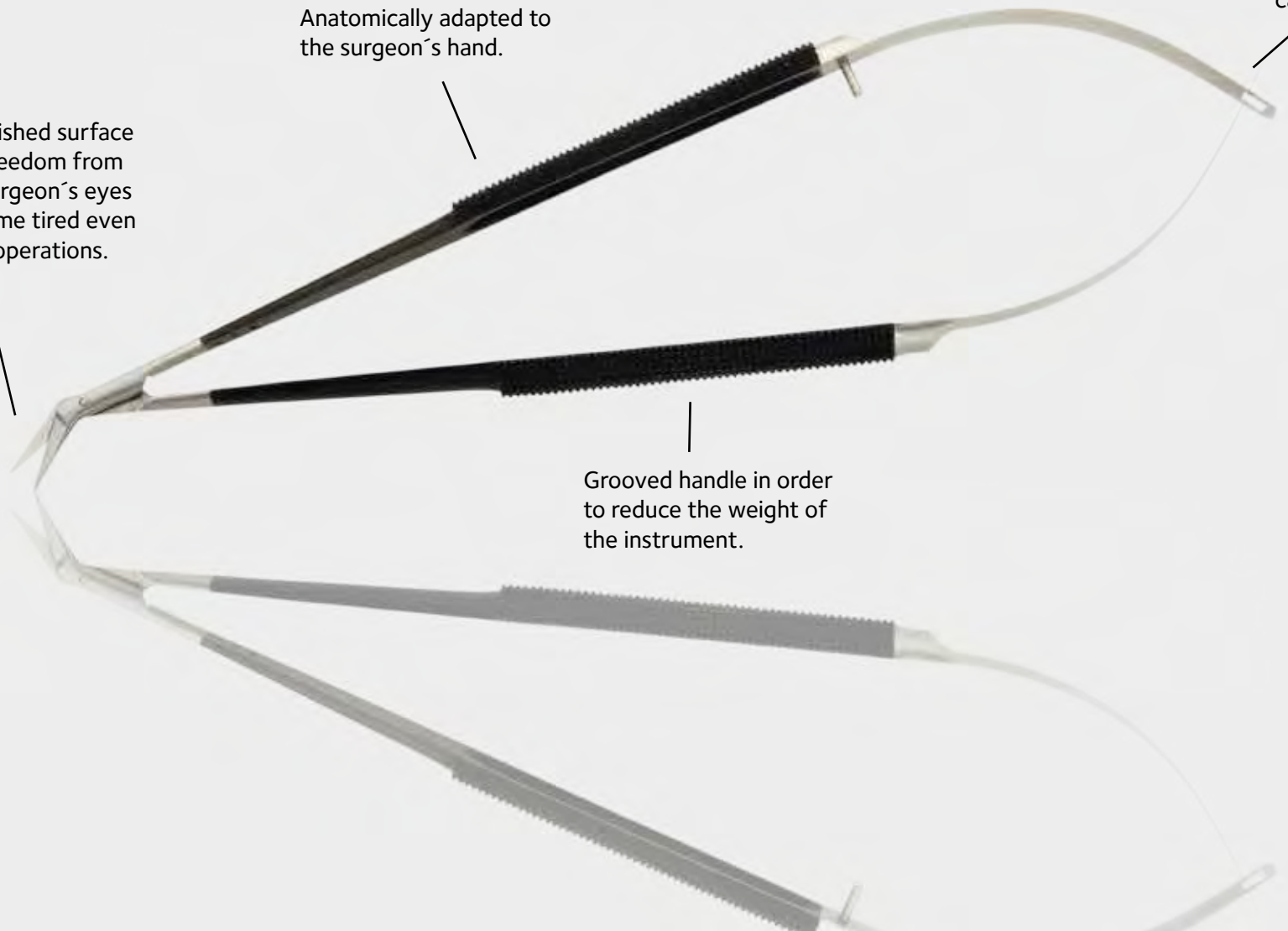



STILLE mikrosax | STILLE Micro Scissors

MIKROSAXAR

Sortimentet består av både raka och böjda modeller i olika längder, bladstorlek och vinklar. Alla modeller är gjorda med STILLE original SuperCut blad för perfekt precision och prestanda i mjuk vävnad. Ledskraven kan tas bort och återmonteras i samband med service. Efter service skall instrumentet fungera med precis samma känsla och pålitlighet som ett nytt instrument.

MICRO SCISSORS

The STILLE Micro scissors consist of both straight and curved models in different lengths, blade sizes and angles. All models are made with the original STILLE Supercut blades for consistent cutting performance in soft tissue. Our joint screw design allows for easy removal during instrument service and repair. After service, the instrument will perform with the same feel and reliability you come to expect from a STILLE instrument.



STILLE mikropincett | STILLE Micro Forceps

MIKROPINCETTER

Alla STILLE mikropincetter är gjorda för att ge samma känsla och balans som våra standard-pincetter. Våra duktiga instrumentmakare är fokuserade på de detaljer som ger perfekt fjäderspänning och matchning av spetsarna för att mjukt och enkelt kunna greppa vävnad och suturer. Pincetterna erbjuds i rostfritt stål eller titan, modeller finns med suturplattform, 1x2 klor, ringspetsar och DeBakey atraumatiska kärpincetter. Käftarna kan fås som standard i rostfritt, eller med Diamond Jaws för utökad hållbarhet och greppstyrka.



STILLE Titan mikropincett | STILLE Titanium Micro Forceps

MICRO FORCEPS

All STILLE Micro Forceps are designed to give the same feel and balance as our standard line of forceps. Our attention to detail by our skilled artisans in Sweden, combines both perfect spring tension and tip alignment for reliable grasping of tissue. They are available in Titanium or stainless steel that include tying platform, 1x2 teeth, ring tips and DeBakey. The tips are available in stainless steel or STILLE Diamond jaws for added durability.



STILLE mikronålförare | STILLE Micro Needle Holder

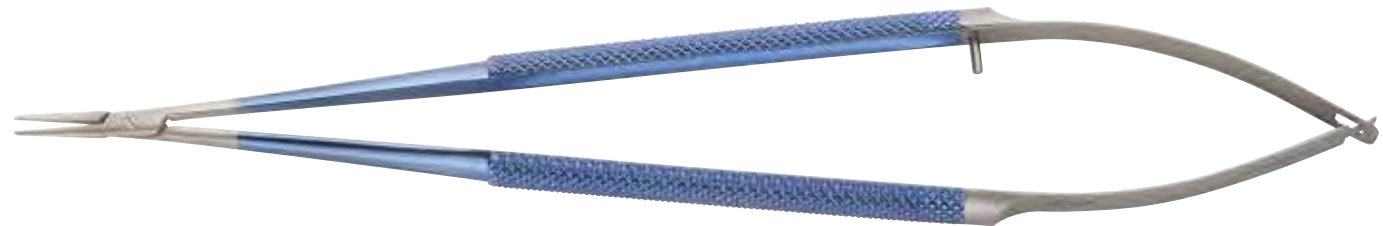

STILLE Titan mikronålförare | STILLE Titanium Micro Needle Holder

MIKRONÅLFÖRARE

STILLES mikronålförare är designade för att hålla även de finaste mikrosuturerna. Bara ett minimalt tryck behövs från kirurgens fingrar för ett säkert grepp. Alla modeller är försedda med STILLE Diamond Jaws eller på de kraftigare modellerna hårdmetallplattor. De erbjuds som raka eller böjda, med- eller utan låsning och i ett flertal olika längder. Leddesign Regular för 7-0 suturer och finare eller Streamline för 5-0 och finare (kraftiga modellerna för 2-0 till 4-0).

MICRO NEEDLE HOLDERS

The STILLE Micro Needle Holders are designed to hold the finest sutures in a tight and secure grip. Only minimal pressure will need to be applied by surgeon's fingers. All models are made with STILLE Diamond Jaws and the heavier models with TC-inserts. They can be delivered as straight or curved, with or without ratchet and in several different lengths. Regular box lock for 7-0 sutures and finer, Streamline box lock for 5-0 sutures and finer. (heavy models for 2-0 to 4-0).



STILLE SuperCut mikrosax | STILLE SuperCut Micro Scissors

Fine micro scissors with straight or curved blades with sharp or blunt tips. All models with **SuperCut** blades.



117-A110
117-A112



117-A111
117-A113

117-A110-15	Sharp tips	Straight	15 cm 6"
117-A110-18	Sharp tips	Straight	18 cm 7"
117-A110-21	Sharp tips	Straight	21 cm 8.25"
117-A112-15	Blunt tips	Straight	15 cm 6 in
117-A112-18	Blunt tips	Straight	18 cm 7 in
117-A112-21	Blunt tips	Straight	21 cm 8.25 in
117-A111-15	Blunt tips	Curved	15 cm 6"
117-A111-18	Blunt tips	Curved	18 cm 7"
117-A111-21	Blunt tips	Curved	21 cm 8.25"
117-A113-15	Sharp tips	Curved	15 cm 6 in
117-A113-18	Sharp tips	Curved	18 cm 7 in
117-A113-21	Sharp tips	Curved	21 cm 8.25 in



STILLE SuperCut mikrokärlsax | STILLE SuperCut Micro Vascular Scissors

SuperCut micro scissors available in five different blade angles for fine vascular surgery. Blade length 11 mm.



117-A120-25
117-A121-25

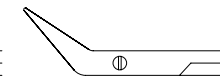

117-A120-45
117-A121-45

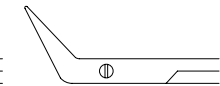

117-A120-60
117-A121-60

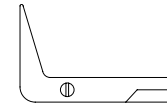

117-A120-90
117-A121-90

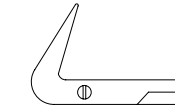

117-A120-125
117-A121-125

117-A120-25	Angled 25°	18 cm 7"
117-A120-45	Angled 45°	18 cm 7"
117-A120-60	Angled 60°	18 cm 7"
117-A120-90	Angled 90°	18 cm 7"
117-A120-125	Angled 125°	18 cm 7"
117-A121-25	Angled 25°	21 cm 8.25 in
117-A121-45	Angled 45°	21 cm 8.25 in
117-A121-60	Angled 60°	21 cm 8.25 in
117-A121-90	Angled 90°	21 cm 8.25 in
117-A121-125	Angled 125°	21 cm 8.25 in

STILLE SuperCut mikrokärlsax | STILLE SuperCut Micro Vascular Scissors

Extra fine blade version of STILLE **SuperCut** vascular micro scissors.
Blade length 7.5 mm.

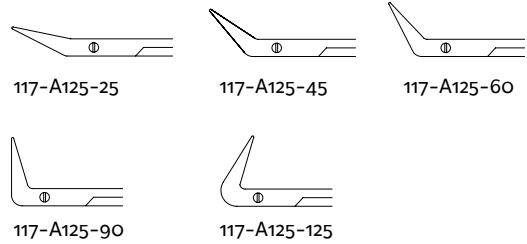

117-A125-25	Angled 25°	18 cm 7"
117-A125-45	Angled 45°	18 cm 7"
117-A125-60	Angled 60°	18 cm 7"
117-A125-90	Angled 90°	18 cm 7"
117-A125-125	Angled 125°	18 cm 7"





STILLE mikropincett | STILLE Micro Forceps

Well balanced and ergonomic micro forceps of ultra high quality. With tying platform and straight or curved jaws. 0.4 mm tips.

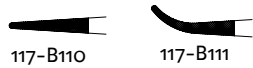

117-B110-15	Straight	15 cm 6"
117-B110-18	Straight	18 cm 7"
117-B110-21	Straight	21 cm 8.25"
117-B110-23	Straight	23 cm 9 in
117-B111-15	Curved	15 cm 6"
117-B111-18	Curved	18 cm 7"
117-B111-21	Curved	21 cm 8.25"



STILLE mikropincett | STILLE Micro Forceps

Same fine micro forceps, with Diamond Jaws, for increased tip durability and secure grip of fine needles. 0.4 mm tips.

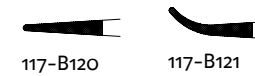

117-B120-15	Diamond Jaws	Straight	15 cm 6"
117-B120-18	Diamond Jaws	Straight	18 cm 7"
117-B120-21	Diamond Jaws	Straight	21 cm 8.25"
117-B120-23	Diamond Jaws	Straight	23 cm 9 in
117-B121-15	Diamond Jaws	Curved	15 cm 6"
117-B121-18	Diamond Jaws	Curved	18 cm 7"
117-B121-21	Diamond Jaws	Curved	21 cm 8.25"



STILLE mikropincett | STILLE Micro Forceps

Micro forceps with Diamond Jaws and Counter-balance. 0.4 mm tips.



117-B130-18	Diamond Jaws	Straight	18 cm 7"
117-B130-21	Diamond Jaws	Straight	21 cm 8.25"
117-B130-23	Diamond Jaws	Straight	23 cm 9 in
117-B131-18	Diamond Jaws	Curved	18 cm 7"
117-B131-21	Diamond Jaws	Curved	21 cm 8.25"

STILLE mikro ringpincett | STILLE Micro Ring Forceps

Counter-balanced micro forceps with fine Diamond Jaws ring tips.



117-B140

117-B140-18	1.0x0.5 mm	Diamond Jaws	Straight	18 cm 7"
117-B140-21	1.0x0.5 mm	Diamond Jaws	Straight	21 cm 8.25"
117-B140-23	1.0x0.5 mm	Diamond Jaws	Straight	23 cm 9 in



STILLE mikro klopincett | STILLE Micro Tissue Forceps

Round handle, with 1x2 fine teeth on 0.4 mm tips.

117-B150-15	1x2 fine teeth	Straight	15 cm 6"
117-B150-18	1x2 fine teeth	Straight	18 cm 7"
117-B150-21	1x2 fine teeth	Straight	21 cm 8.25"



STILLE DeBakey mikropincett | STILLE Micro DeBakey Forceps

Round handle, with 1.2 mm fine atraumatic DeBakey tips.

117-B160-18	1.2 mm	DeBakey tips	Straight	18 cm 7 in
117-B160-21	1.2 mm	DeBakey tips	Straight	21 cm 8.25 in



STILLE DeBakey mikropincett | STILLE Micro DeBakey Forceps

Round handle, with 1.2 mm fine atraumatic DeBakey tips, counter-balanced.

117-B165-18	1.2 mm	DeBakey tips	Straight	18 cm 7 in
117-B165-21	1.2 mm	DeBakey tips	Straight	21 cm 8.25 in



STILLE Titan mikropincett
| **STILLE Titanium Micro Forceps**

Round handle, with tying platform, straight or curved 0.4 mm tips.

117-B120-18-TI	Diamond Jaws	Straight	18 cm 7 in
117-B120-21-TI	Diamond Jaws	Straight	21 cm 8.25 in
117-B120-23-TI	Diamond Jaws	Straight	23 cm 9 in
117-B120-25-TI	Diamond Jaws	Straight	25 cm 10 in
117-B121-18-TI	Diamond Jaws	Curved	18 cm 7 in
117-B121-21-TI	Diamond Jaws	Curved	21 cm 8.25 in
117-B121-23-TI	Diamond Jaws	Curved	23 cm 9 in
117-B121-25-TI	Diamond Jaws	Curved	25 cm 10 in



STILLE Titan mikropincett
| **STILLE Titanium Micro Forceps**

Round handle, with tying platform, counter-balanced, straight or curved 0.4 mm tips.

117-B130-18-TI	Diamond Jaws	Straight	18 cm 7 in
117-B130-21-TI	Diamond Jaws	Straight	21 cm 8.25 in
117-B131-18-TI	Diamond Jaws	Curved	18 cm 7 in
117-B131-21-TI	Diamond Jaws	Curved	21 cm 8.25 in





STILLE Titan mikro ringpincett | STILLE Titanium Micro Ring Forceps

Round handle, with fine ring tips, counter-balanced.

117-B140-18-TI	Diamond Jaws	1.0x0.5 mm ring tips	Straight	18 cm 7 in
117-B140-21-TI	Diamond Jaws	1.0x0.5 mm ring tips	Straight	21 cm 8.25 in
117-B140-23-TI	Diamond Jaws	1.0x0.5 mm ring tips	Straight	23 cm 9 in



STILLE Titan DeBakey mikropincett | STILLE Titanium Micro DeBakey Forceps

Round handle, with 1.2 mm fine atraumatic DeBakey tips.

117-B160-18-TI	1.2 mm DeBakey tips	Straight	18 cm 7 in
117-B160-21-TI	1.2 mm DeBakey tips	Straight	21 cm 8.25 in





STILLE mikro nålförare | STILLE Micro Needle Holder

Round handle, fine 0.8 mm Diamond Jaws and **Regular Box Lock** for sutures 7-0 and smaller. Without ratchet.



117-C110-15	Diamond Jaws	Straight	15 cm 6"
117-C110-18	Diamond Jaws	Straight	18 cm 7"
117-C110-21	Diamond Jaws	Straight	21 cm 8.25"
117-C110-23	Diamond Jaws	Straight	23 cm 9"
117-C111-15	Diamond Jaws	Curved	15 cm 6"
117-C111-18	Diamond Jaws	Curved	18 cm 7"
117-C111-21	Diamond Jaws	Curved	21 cm 8.25"
117-C111-23	Diamond Jaws	Curved	23 cm 9"

STILLE mikro nålförare | STILLE Micro Needle Holder

Round handle, 1.2 mm Diamond Jaws and **Streamline Box Lock** for sutures 5-0 and smaller. Without ratchet.

117-C115-15	Diamond Jaws	Without Ratchet	Straight	15 cm 6 in
117-C115-18	Diamond Jaws	Without Ratchet	Straight	18 cm 7 in
117-C115-21	Diamond Jaws	Without Ratchet	Straight	21 cm 8.25 in
117-C115-23	Diamond Jaws	Without Ratchet	Straight	23 cm 9 in
117-C116-15	Diamond Jaws	Without Ratchet	Curved	15 cm 6 in
117-C116-18	Diamond Jaws	Without Ratchet	Curved	18 cm 7 in
117-C116-21	Diamond Jaws	Without Ratchet	Curved	21 cm 8.25 in
117-C116-23	Diamond Jaws	Without Ratchet	Curved	23 cm 9 in



STILLE mikro nålförare | STILLE Micro Needle Holder

Round handle, fine 0.8 mm Diamond Jaws and **Regular Box Lock** for sutures 7-0 and smaller. With ratchet.

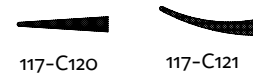

117-C120-15	Diamond Jaws	Straight	15 cm 6"
117-C120-18	Diamond Jaws	Straight	18 cm 7"
117-C120-21	Diamond Jaws	Straight	21 cm 8.25"
117-C120-23	Diamond Jaws	Straight	23 cm 9"
117-C121-15	Diamond Jaws	Curved	15 cm 6"
117-C121-18	Diamond Jaws	Curved	18 cm 7"
117-C121-21	Diamond Jaws	Curved	21 cm 8.25"
117-C121-23	Diamond Jaws	Curved	23 cm 9"



STILLE mikro nålförare | STILLE Micro Needle Holder

Round handle, 1,2 mm Diamond Jaws and **Streamline Box Lock** for sutures 5-0 and smaller. With ratchet.

117-C125-15	Diamond Jaws	With Ratchet	Straight	15 cm 6 in
117-C125-18	Diamond Jaws	With Ratchet	Straight	18 cm 7 in
117-C125-21	Diamond Jaws	With Ratchet	Straight	21 cm 8.25 in
117-C125-23	Diamond Jaws	With Ratchet	Straight	23 cm 9 in
117-C126-15	Diamond Jaws	With Ratchet	Curved	15 cm 6 in
117-C126-18	Diamond Jaws	With Ratchet	Curved	18 cm 7 in
117-C126-21	Diamond Jaws	With Ratchet	Curved	21 cm 8.25 in
117-C126-23	Diamond Jaws	With Ratchet	Curved	23 cm 9 in



STILLE mikro nålförare | STILLE Micro Needle Holder

Extra heavy model for handling of larger needles with TC-inserts. Intended for 2/0 suture and finer.



117-C130
117-C140

117-C130-19	TC-inserts	Without lock	19 cm 7.5"
117-C130-23	TC-inserts	Without lock	23 cm 9"
117-C130-25	TC-inserts	Without lock	25 cm 9.75"
117-C140-19	TC-inserts	With lock	19 cm 7.5"
117-C140-23	TC-inserts	With lock	23 cm 9"
117-C140-25	TC-inserts	With lock	25 cm 9.75"



STILLE Titan mikronålförare
| **STILLE Titanium Micro Needle Holder**

Round handle, fine 0.8 mm Diamond Jaws and **Regular Box Lock** for sutures 7-0 and smaller. With or without ratchet.

117-C110-18-TI	Diamond Jaws	Without Ratchet	Straight	18 cm 7 in
117-C110-21-TI	Diamond Jaws	Without Ratchet	Straight	21 cm 8.25 in
117-C110-23-TI	Diamond Jaws	Without Ratchet	Straight	23 cm 9 in
117-C111-15-TI	Diamond Jaws	Without Ratchet	Curved	15 cm 6 in
117-C111-18-TI	Diamond Jaws	Without Ratchet	Curved	18 cm 7 in
117-C111-21-TI	Diamond Jaws	Without Ratchet	Curved	21 cm 8.25 in
117-C120-18-TI	Diamond Jaws	With Ratchet	Straight	18 cm 7 in
117-C120-21-TI	Diamond Jaws	With Ratchet	Straight	21 cm 8.25 in
117-C120-23-TI	Diamond Jaws	With Ratchet	Straight	23 cm 9 in
117-C121-18-TI	Diamond Jaws	With Ratchet	Curved	18 cm 7 in
117-C121-21-TI	Diamond Jaws	With Ratchet	Curved	21 cm 8.25 in
117-C121-23-TI	Diamond Jaws	With Ratchet	Curved	23 cm 9 in





STILLE Titan mikronålförare | STILLE Titanium Micro Needle Holder

Round handle, 1.2 mm Diamond Jaws and **Streamline Box Lock** for sutures 5-0 and smaller. With or without ratchet.

117-C115-18-TI	Diamond Jaws	Without Ratchet	Straight	18 cm 7 in
117-C115-21-TI	Diamond Jaws	Without Ratchet	Straight	21 cm 8.25 in
117-C115-23-TI	Diamond Jaws	Without Ratchet	Straight	23 cm 9 in
117-C125-18-TI	Diamond Jaws	With Ratchet	Straight	18 cm 7 in
117-C125-21-TI	Diamond Jaws	With Ratchet	Straight	21 cm 8.25 in
117-C125-23-TI	Diamond Jaws	With Ratchet	Straight	23 cm 9 in
117-C126-18-TI	Diamond Jaws	With Ratchet	Curved	18 cm 7 in
117-C126-21-TI	Diamond Jaws	With Ratchet	Curved	21 cm 8.25 in
117-C126-23-TI	Diamond Jaws	With Ratchet	Curved	23 cm 9 in





STILLE ERBJUDER ett antal övriga instrument som komplement till huvudsortimentet. Här finns exempelvis unika produkter som STILLES artroskopikanyler, STILLE Hemostop och instrumentvårdsprodukter. Här kan man också hitta vårt utvalda sortiment av ortopediska implantat av högsta kvalitet, där Palmerstift, Wibergmärlor och Kirschner trådborrar ingår.



STILLE OFFERS a number of various instruments as a complement to the main offering. Included here are among other products, STILLE Arthroset, STILLE Hemostop and instrument care products. In this section we also offer a selected range of top quality orthopaedic implants, such as our well-known Palmer bone nails, Wiberg fracture staples and Kirschner wire drills.

Övriga instrument | Various instruments | Sonstige
Instrumente | Altri strumenti | Instrumentos varios |
様々な器具

Ergonomic design ensures
comfortable grip and exact
handling of delicate tissue.

All instruments are manufactured in
selected top quality surgical steel.

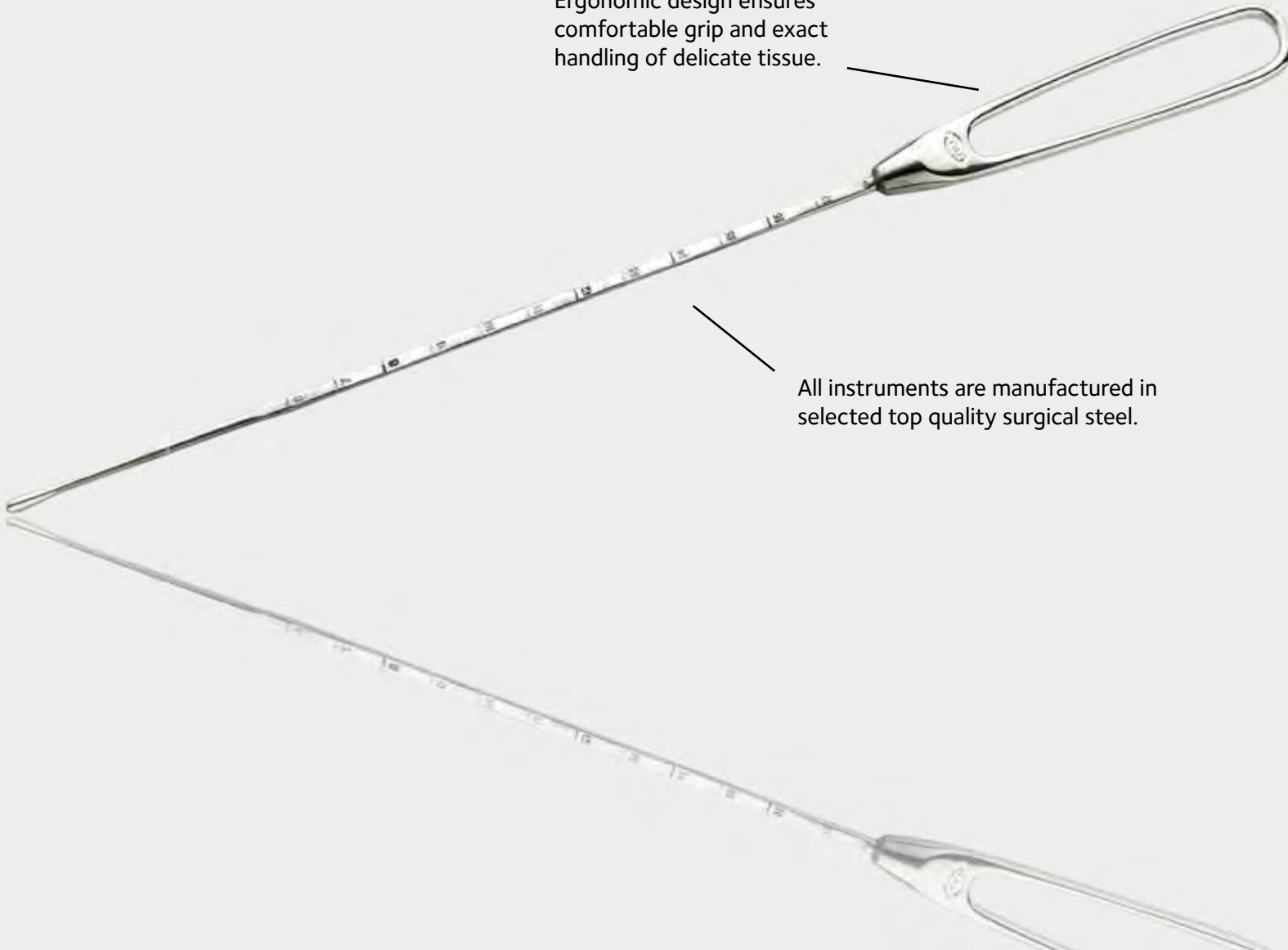

Gillquist-STILLE artroskopisugrör | Gillquist-STILLE Arthroscopy Suction Tube

Arthroscopy suction tube with mandrin.

119-10915 28 cm 11"



Oretorp-STILLE sond | Oretorp-STILLE Probe

Blunt ended probe for arthroscopy. Graduated shaft.

119-10928 Blunt 19.5 cm 7.75"



STILLE sond | STILLE Probe

Blunt ended probe for arthroscopy. Graduated shaft.

119-10928-1 Blunt 19.5 cm 7.75"



STILLE uterussond | STILLE Uterine Sound

Uterine sound with malleable silver shaft. Graduated in cm. Drop-shaped tip.



119-28452 27 cm 10.75"

Bergström-STILLE muskelbiopsi kanyl | Bergström-STILLE Muscle biopsy Cannula

Muscle biopsy cannula. Consists of a sharptipped, hollow outer needle with a small opening near the tip. A punch with a sharp edge fits tightly into the needle. The stylet is used for pushing out biopsy specimens from the punch.



119-29187-50 Diam 5 mm
119-29187-60 Diam 6 mm

STILLE Jameson skjutmått | STILLE Jameson Caliper

Caliper graduated 0-80 mm.

119-30025 0-80 mm 0-3" 9.5 cm 3.75"



STILLE Castroviejo skjutmått | STILLE Castroviejo Caliper

Caliper with locking screw, graduated 0-20 mm.

119-30022 0-20 mm 8 cm 3.1"



STILLE mätsticka | STILLE Ruler

Stainless steel ruler graduated in mm, 0-15 cm.

119-30010-15 15 cm 6"





STILLE skalpellhandtag | STILLE Scalpel Handle

The most common scalpel handles made with highest precision.

119-50010-3	No 3	Blade 10-15	12 cm 5"
119-50010-13	No 3L	Blade 10-15	21 cm 8.25"
119-50010-4	No 4	Blade 18-25	13 cm 5.25"
119-50010-14	No 4L	Blade 18-25	21 cm 8.25"
119-50010-7	No 7	Blade 10-15	16 cm 6.25"



STILLE Barron skalpellhandtag | STILLE Barron Scalpel Handle

8-sided handle for precise handling and rotation.

119-50012	Blade 10-15	14 cm 5,5"
-----------	-------------	------------

STILLE skalpellhandtag | STILLE Scalpel Handle

Round handle guarantees precise finger tip control.

119-50015	Blade 10-15	14.5 cm 5.75"
-----------	-------------	---------------



STILLE Mayo peanghängare | STILLE Mayo Safety Pin

Safety Pin with ball for better control of instruments on the tray.

119-50022 13,5 cm 5.25"

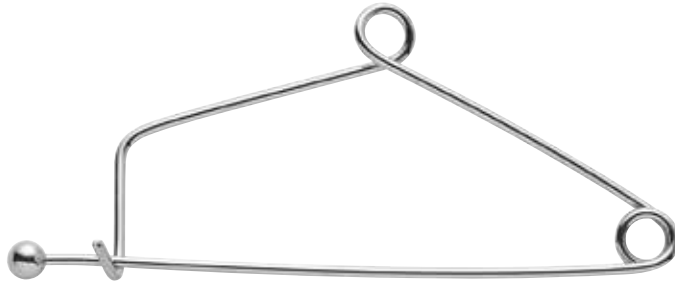

STILLE Hemostop | STILLE Hemostop

Designed as an aid to stemming complicated venous and arterial bleeding during open surgery. Relatively long to be able to reach down into the pelvis.

119-60001 Ring diameter 18/28 mm 24 cm 9.5"





STILLE instrumentolja | STILLE Instrument Oil

Instrument oil, package of 2 pcs á 50 ml.

119-78900-1 50 ml, package of 2 pcs

STILLE rengöringsborste | STILLE Cleaning Brush

Cleaning brush for surgical instruments. Special stainless steel fine threaded, bristle diameter 0.12 mm, height 20 mm. Handy grip of plastic material. Autoclavable at 121C.

119-78950 20 cm 8", package 2 pcs



STILLE Instrumentbricka | STILLE Instrument Sterilization Tray

Instrument tray for transport, sterilization and storage of delicate instruments. The trays are designed to assure proper penetration of sterilizing agent between the mat and the tray surface. Silicone mat included. Available in three different sizes. The trays are made to withstand common sterilization methods, including steam, gas, cold sterilization solutions, and temperatures up to 182°C/360 F.

199-60010	Micro tray	10.1x19x1.9 cm	4x7.5x0.75"
199-60020	Micro tray	15.2x25.4x1.9 cm	6x10x0.75"
199-60030	Instrument tray	25.4x38.1x1.9 cm	10x15x0.75"

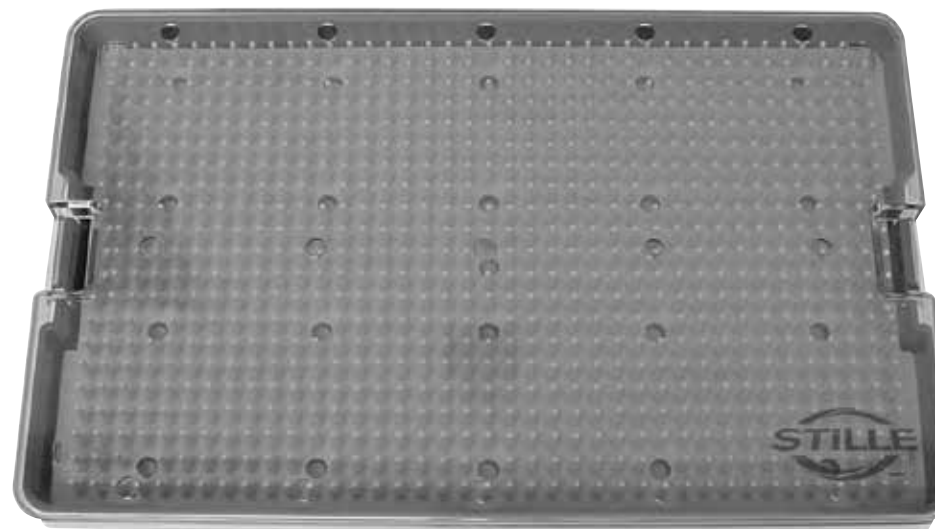

STILLE-Gigli trådsåg | STILLE-Gigli Wire Saw

Gigli wire saw with superior cutting quality. Smooth joints between loops and wire. Available in three different lengths.

125-19150-30	Pack of 25 pcs	30 cm 12"
125-19150-40	Pack of 25 pcs	40 cm 15.75"
125-19150-50	Pack of 25 pcs	50 cm 20"
125-19160	Handle	6.5 cm 2.5"
125-19170	Guide/Dura Protector	34 cm 13"



125-19160

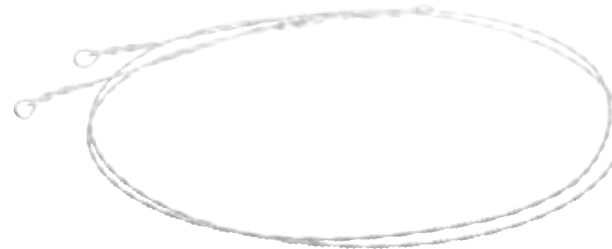

125-19150-40



125-19170

STILLE artroskopikanylset | STILLE Arthroscopy Cannula Set

STILLE Arthroscopy cannula set is designed for maximal outflow through same diameter in inner diameter, drainage holes, connection and tubing - no interruptions. As an extra benefit a connector is added in all packages, offering the possibility to use it for intraarticular injection of saline before operating. Tubing 195 cm. Carton of 4 x 20 pcs, length 95 mm.

415-2020	Sterile	ID 2.5 mm	OD 4.0 mm
415-2025-400	Sterile	ID 4.0 mm	OD 5.4 mm



STILLE gipssåg | STILLE Plaster Cast Remover

A complete kit of plaster cast removers including wire saws in two lengths, stainless steel handles and plastic profiles.

413-2500-2	Metal Handle		
413-2502-85	Wire Saws	100 pcs	85 cm 33.5"
413-2502-125	Wire Saws	100 pcs	125 cm 49.25"
413-2504-85	Soft Profiles	100 pcs	85 cm 33.5"
413-2504-125	Soft Profiles	100 pcs	125 cm 49.25"



STILLE frakturtråd | STILLE Bone Wire

STILLE bone wire on 5 m coils. Not available in USA.

121-18013-4	Stainless	0.4 mm	5 m coils diam ,soft
121-18013-5	Stainless	0.5 mm	5 m coils diam, soft
121-18013-6	Stainless	0.6 mm	5 m coils diam, soft
121-18013-7	Stainless	0.7 mm	5 m coils diam, soft
121-18013-8	Stainless	0.8 mm	5 m coils diam, soft
121-18013-9	Stainless	0.9 mm	5 m coils diam, soft
121-18013-10	Stainless	1.0 mm	5 m coils diam, soft



Palmer-STILLE benstift | Palmer-STILLE Bone Nail

Round bone nails with diameter 1.5 mm. Not available in USA.

121-18224-15	Stainless	Round	Length 15 mm
121-18224-20	Stainless	Round	Length 20 mm
121-18224-25	Stainless	Round	Length 25 mm
121-18224-30	Stainless	Round	Length 30 mm
121-18224-35	Stainless	Round	Length 35 mm
121-18224-40	Stainless	Round	Length 40 mm
121-18224-45	Stainless	Round	Length 45 mm
121-18224-50	Stainless	Round	Length 50 mm
121-18224-55	Stainless	Round	Length 55 mm
121-18224-60	Stainless	Round	Length 60 mm
121-18224-65	Stainless	Round	Length 65 mm
121-18224-70	Stainless	Round	Length 70 mm
121-18227	Holder/Driver		12 cm 5.7"
121-18229	Impactor		17 cm 6.75"





Wiberg-STILLE benmärla | Wiberg-STILLE Fracture Staple

Fracture staples in three different sizes. Not available in USA.

121-18251-16	Stainless	16 mm
121-18251-19	Stainless	19 mm
121-18251-22	Stainless	22 mm
121-18255	Holder/Driver	17 cm 6.75"

STILLE Kirschner trådborr | STILLE Kirschner Wire Drill

Wire drills with lancet points with or without eye. Not available in USA.

121-19357-11	Without eye	1.1 mm	23.5 cm 9.25"
121-19357-13	Without eye	1.3 mm	23.5 cm 9.25"
121-19357-15	Without eye	1.5 mm	23.5 cm 9.25"
121-19357-18	Without eye	1.8 mm	23.5 cm 9.25"
121-19357-20	Without eye	2.0 mm	23.5 cm 9.25"
121-19357-213	With eye	1.3 mm	23.5 cm 9.25"
121-19357-215	With eye	1.5 mm	23.5 cm 9.25"
121-19357-218	With eye	1.8 mm	23.5 cm 9.25"
121-19357-220	With eye	2.0 mm	23.5 cm 9.25"



DR. HERBERT OLIVECRONA, professor i neurokirurgi vid Karolinska institutet, pionjär inom neurokirurgi vid Serafimerlasarettet, läkare vid Sabbatsbergs sjukhus samt ledamot av Kungliga Vetenskapsakademien. Utvecklade flera instrument tillsammans med STILLE, såsom kyretter, peanger och pincetter.

DR. HERBERT OLIVECRONA, professor of neurosurgery at the Karolinska Institute, a pioneer in neurosurgery at the Serafimer Hospital, doctor at Sabbatsberg Hospital and member of the Royal Swedish Academy of Sciences. Developed several instruments in collaboration with STILLE, such as curettes, artery forceps and forceps.

Numeriskt index | Numerical index | Nummernverzeichnis | Indice di numeri | Índice de números | 品番索引

Art nr	Page	Art nr	Page	Art nr	Page	Art nr	Page	Art nr	Page	Art nr	Page	Art nr	Page
101		101-8084-19	20	101-8166-2	38	101-8175-20	27	101-8411	44	102-9024	57	102-9318	61
101-8001	16	101-8085-15	21	101-8167	36	101-8175-20-C	27	101-8420	34	102-9025	57	102-9320	61
101-8002	16	101-8085-17	21	101-8167-1	36	101-8175-23	27	101-8425	44	102-9025-1	57	102-9322	61
101-8003	16	101-8085-19	21	101-8167-1-C	37	101-8175-23-C	27	101-8430-171	46	102-9027	54	102-9330	61
101-8004	16	101-8086-15	20	101-8167-151	36	101-8175-26	27	101-8430-172	46	102-9028	55	102-9340	61
101-8010	16	101-8086-17	20	101-8167-151-C	37	101-8175-26-C	27	101-8431-171	46	102-9030-13	57	102-9342	61
101-8010-1	16	101-8086-19	20	101-8167-152	38	101-8175-30	27	101-8431-172	46	102-9030-15	57	102-9354	61
101-8011	16	101-8087-15	21	101-8167-153D	39	101-8175-30-C	27	101-8433-20	46	102-9030-17	57	102-9460	60
101-8011-1	16	101-8087-17	21	101-8167-153D-C	39	101-8175-33	27	101-8433-202	46	102-9030-20	57	102-9470	60
101-8015	16	101-8087-19	21	101-8167-153U	39	101-8176-15	27	101-8435-20	46	102-9030-25	57	102-9845-15	62
101-8015-1	16	101-8090	21	101-8167-153U-C	39	101-8176-18	27	101-8435-202	46	102-9040-15	57	102-9845-20	62
101-8016	16	101-8092	21	101-8167-181	36	101-8176-20	27	101-8436-20	46	102-9040-17	57	102-9845-25	62
101-8016-1	16	101-8096-20	33	101-8167-181-C	37	101-8176-23	27	101-8440-201	47	102-9040-20	57	102-9846-20	63
101-8018-1	17	101-8096-23	33	101-8167-182	38	101-8176-26	27	101-8441-201	47	102-9040-25	57	102-9852-20	62
101-8019-1	17	101-8097-20	34	101-8167-2	38	101-8200-125	40	101-8442-171	47	102-9040-30	57	102-9852-25	62
101-8019-2	17	101-8097-23	34	101-8167-2-C	38	101-8200-25	40	101-8452	47	102-9050-13	55	102-9852-30	62
101-8020	18	101-8098-20	33	101-8170-1	36	101-8200-45	40	101-8456-171	48	102-9060-15	55	102-9855-20	62
101-8021	18	101-8098-23	33	101-8171-1	36	101-8200-60	40	101-8458-17	48	102-9060-17	55	102-9855-25	62
101-8021-1	18	101-8098-30	33	101-8172-18	24	101-8200-90	40	101-8458-172	48	102-9060-20	55		
101-8022	18	101-8099-20	34	101-8172-23	24	101-8201-125	40	101-8458-20	48	102-9062-15	55	103	
101-8025	42	101-8099-23	34	101-8173-15	24	101-8201-25	40	101-8458-202	48	102-9062-17	55	103-10015-131	66
101-8031-1	17	101-8099-30	34	101-8173-15-C	25	101-8201-45	40	101-8459-20	48	102-9062-20	55	103-10026-121	66
101-8031-2	17	101-8100-15	21	101-8173-153D	26	101-8201-60	40	101-8460	35	102-9077-20	58	103-10028-121	66
101-8042-15	33	101-8102-15	21	101-8173-153D-C	26	101-8201-90	40	101-8470	32	102-9078-20	58	103-10030-121	66
101-8043-15	33	101-8110	42	101-8173-153U	26	101-8378	30	101-8490	41	102-9244-15	59	103-10032-121	66
101-8047-13	33	101-8110-1	42	101-8173-153U-C	26	101-8380-12	30	101-8490-2	41	102-9244-20	59	103-10032-181	66
101-8047-15	33	101-8115	42	101-8173-18	24	101-8380-121	30	101-8580	35	102-9244-25	59	103-10035-121	66
101-8048-15	33	101-8115-1	42	101-8173-18-C	25	101-8380-121-C	31	101-8584	50	102-9248-15	56	103-10037-121	66
101-8048-18	33	101-8120	43	101-8173-20	24	101-8380-122	32	101-8586-9	50	102-9248-20	56	103-10115-141	67
101-8060	18	101-8120-1	43	101-8174-15	25	101-8380-15	30	101-8595-18	50	102-9248-25	56	103-10117-141	67
101-8060-1	19	101-8122	43	101-8174-151	25	101-8380-151	30	101-8597-14	51	102-9252-20	56	103-10150-141	67
101-8060-2	19	101-8123	43	101-8174-20	25	101-8380-151-C	31	101-8604	45	102-9252-25	56	103-10152-141	67
101-8062	18	101-8123-1	43	101-8174-23	25	101-8380-152	32	101-8815-12	51	102-9252-30	56	103-10160-161	68
101-8062-1	19	101-8125	43	101-8174-26	25	101-8380-153D	31			102-9254	58	103-10162-161	68
101-8062-2	19	101-8138	22	101-8175-15	27	101-8380-153D-C	31	102		102-9255-20	58	103-10172	68
101-8080-15	19	101-8160	22	101-8175-15-C	27	101-8380-153U	31	102-9019	54	102-9255-25	58	103-10180-141	69
101-8080-17	19	101-8161	23	101-8175-152	28	101-8380-153U-C	31	102-9020	57	102-9270-20	56	103-10180-161	69
101-8081-15	20	101-8162	22	101-8175-153D	28	101-8380-18	30	102-9020-1	57	102-9300	61	103-10180-181	69
101-8082-15	19	101-8163	23	101-8175-153D-C	29	101-8380-181	30	102-9020-15	57	102-9302	61	103-10182-141	69
101-8082-17	19	101-8163-2	23	101-8175-153U	28	101-8380-181-C	31	102-9021	54	102-9304	61	103-10182-161	69
101-8083-15	20	101-8163-C	23	101-8175-153U-C	29	101-8380-20	30	102-9021-1	54	102-9308	61	103-10182-181	69
101-8084-15	20	101-8164	49	101-8175-18	27	101-8380-201	30	102-9022	54	102-9312	61	103-10185	69
101-8084-17	20	101-8166	36	101-8175-18-C	27	101-8380-23	30	102-9022-15	54	102-9314	61	103-10185-161	69
		101-8166-1	36	101-8175-182	28	101-8380-231	30	102-9023-12	54	102-9316	61	103-10187-141	69

Art nr	Page	Art nr	Page	Art nr	Page	Art nr	Page	Art nr	Page	Art nr	Page	Art nr	Page	
103-10187-161	69	104-15556	84	105		105-17643-3-C	112	107-12487	136	108-24935-35	151	111-20340-7	162	
103-10190	70	104-15557	84		105-17643-4	111	105-17643-4-C	112	107-12488	136	108-24935-40	151	111-20340-8	162
103-10192	70	104-15558	84		105-13921-18	113	105-17643-5	111	107-12489	136	108-24935-55	151	111-20350-10	162
103-10195	70	104-15559	84		105-13921-18-C	113	105-17644-2	111	107-12490	136	108-24940-55	151	111-20350-12	162
103-10197	70	104-15560	85		105-13931-18	113	105-17644-2-C	112	107-12491	134	108-25011-1	142	111-20350-7	162
103-10200-161	70	104-15560-2	85		105-13931-18-C	113	105-17644-3	111	107-12563	132	108-25012-10	142	111-20350-8	162
103-10200-181	70	104-15561-141	85		105-13941-18	114	105-17644-3-C	112	107-13120-15	133	108-25012-2	142	111-20502-10	163
103-10202-161	70	104-15561-161	85		105-13941-18-C	114	105-17644-4	111	107-13120-21	133	108-25012-5	142	111-20502-12	163
103-10202-181	70	104-15561-181	85		105-13955-18	115	105-17644-4-C	112	107-13130-15	134	108-25012-7	142	111-20502-2	163
103-10205-161	71	104-15561-201	85		105-13955-18-C	115	105-17644-5	111	107-13130-19	134	108-25031-3	143	111-20502-3	163
103-10205-181	71	104-15561-251	85		105-13956-18	115	105-17644-5-C	112	107-13130-25	134	108-25031-5	143	111-20502-4	163
103-10207-161	71	104-15562-161	86		105-13957-18	115	105-17644-5-C	112	107-13280	137	108-25031-7	143	111-20502-5	163
103-10207-181	71	104-15562-181	86		105-13957-18-C	115	105-17644-5-C	112	107-13290	138	108-25940	148	111-20502-6	163
103-10210-201	71	104-15562-201	86								108-26011	148	111-20502-7	163
103-10210-241	71	104-15562-241	86		105-16015	96					108-26015	149	111-20502-8	163
103-10212-201	71	104-15562-271	86		105-16020	97					108-26037-19	149	111-20503-2	163
103-10212-241	71	104-15562-301	86		105-16020-1	97					108-26037-22	149	111-20503-3	163
103-10212-301	71	104-15565-151	86		105-16150	108	107-10571-241	119	108-23780-35	153	108-26037-25	149	111-20503-4	163
103-10215-201	72	104-15565-181	86		105-16152	108	107-10581-241	119	108-23780-45	153	108-26038	150	111-20503-5	163
103-10215-241	72	104-15565-201	86		105-16215	109	107-10655	120	108-24110	142	108-26046-10	150	111-20503-6	163
103-10217-201	72	104-15565-231	86		105-16223	109	107-10656	120	108-24112	142	108-26046-12	150	111-21305-10	178
103-10217-241	72	104-15566-151	87		105-16225	110	107-10665	120	108-24116	143	108-26046-14	150	111-21305-12	178
103-10220-201	72	104-15566-181	87		105-16510	98	107-10670	120	108-24117	143	108-26046-8	150	111-21305-4	178
103-10222-201	72	104-15566-201	87		105-16512	98	107-10671	120	108-24320	144	108-26048-7	144	111-21305-6	178
103-10240-161	73	104-15566-231	87		105-16811	99	107-10695	123	108-24380	145	108-26252	55	111-21305-8	178
103-10260-191	73	104-15573-161	88		105-17030	100	107-10696	123	108-24385-15	145	108-26253	155	111-21306-10	178
103-10262-191	73	104-15573-181	88		105-17210	101	107-10697	123	108-24385-8	145	108-26254	155	111-21306-2	178
103-10310	74	104-15573-201	88		105-17211	101	107-10825	121	108-24400-1	146	108-26255	155	111-21306-4	178
103-10411-201	74	104-15573-181	88		105-17215	101	107-10826	121	108-24400-2	146	108-26256	155	111-21306-6	178
103-10413-211	75	104-15585-161	89		105-17216	102	107-10840	124	108-24400-3	146	108-26257	155	111-21306-8	178
103-10413-241	75	104-15585-181	89		105-17217	102	107-10841	124	108-24401-2	146	108-26261	155	111-21310-10	179
103-10416	77	104-15585-221	89		105-17220	102	107-10842	124	108-24401-3	146	108-26262	155	111-21310-12	179
103-10420-201	76	104-15585-251	89		105-17230	103	107-10845	127	108-24402-2	146	108-26610	156	111-21310-15	179
103-10421-211	76	104-15586	89		105-17250	104	107-10846	128	108-24402-3	146	108-26615	156	111-21310-6	179
103-10422-211	76	104-15590-121	90		105-17260	105	107-10849	128	108-24403-2	146	108-26846-10	150	111-21310-8	179
103-10423-1	78	104-15590-131	90		105-17261	105	107-10860	126	108-24403-3	146	108-26846-12	150	111-21312-10	185
103-10423-2	78	104-15590-171	90	105-17265	106	107-10861	126	108-24680-1	146	108-26846-14	150	111-21312-12	185	
103-10423-3	78	104-15590-181	90	105-17266	106	107-10862	126	108-24680-2	146	108-26846-8	150	111-21312-15	185	
103-10423-4	78	104-15621-179	90	105-17267	107	107-10862	126	108-24680-3	146	108-26865	152	111-21312-6	185	
103-10425	76	104-15621-209	90	105-17268	107	107-10871	125	108-24680-4	146	108-26931	157	111-21312-8	185	
103-10428-151	78	104-15665-151	87	105-17269	107	107-10872	122	108-24682-2	146	108-26931-100	157	111-21315-10	186	
103-10430-241	77	104-15777	91	105-17642-2	111	107-10876	122	108-24682-3	146	108-26931-80	157	111-21315-12	186	
		104-15785	91	105-17642-2-C	112	107-10880	129	108-24682-4	146	108-27011-1	158	111-21315-15	186	
		104-15832	93	105-17642-3	111	107-10888	130	108-24805	154	108-27011-2	158	111-21315-6	186	
		104-15835	93	105-17642-3-C	112	107-10910	131	108-24808	147	108-27011-3	158	111-21315-8	186	
		104-15854	93	105-17642-4	111	107-10912	131	108-24812-7	147	108-27021-2	158	111-21330-10	179	
		104-15855	93	105-17642-4-C	112	107-10916	132	108-24812-10	147			111-21330-12	179	
		104-15856	93	105-17642-5	111	107-12370-20	132	108-24814-15	147			111-21330-15	179	
				105-17642-5-C	112	107-12478	135	108-24814-20	147			111-21330-20	179	
				105-17643-2	111	107-12479	135	108-24816-20	147	111		111-21330-25	179	
				105-17643-2-C	112	107-12485	136	108-24816-20	147	111-19381	187	111-21330-25	179	
				105-17643-3	111	107-12486	136	108-24930-20	151	111-20340-10	162	111-21330-15	179	
								108-24930-30	151	111-20340-5	162	111-21330-30	179	

Art nr	Page	Art nr	Page	Art nr	Page	Art nr	Page	Art nr	Page	Art nr	Page
111-21335-10	186	111-22140-6	169	117-A113-18	194	117-B140-21-TI	199	117-C125-15	201	121-18224-15	214
111-21335-12	186	111-22150	164	117-A113-21	194	117-B140-23	197	117-C125-18	201	121-18224-20	214
111-21335-15	186	111-22155-10	164	117-A120-125	194	117-B140-23-TI	199	117-C125-18-TI	203	121-18224-25	214
111-21335-20	186	111-22155-13	164	117-A120-25	194	117-B150-15	197	117-C125-21	201	121-18224-30	214
111-21441-15	180	111-22155-19	164	117-A120-45	194	117-B150-18	197	117-C125-21-TI	203	121-18224-35	214
111-21441-20	180	111-22155-25	164	117-A120-60	194	117-B150-21	197	117-C125-23	201	121-18224-40	214
111-21441-25	180	111-22158-9	165	117-A120-90	194	117-B160-18	197	117-C125-23-TI	203	121-18224-45	214
111-21441-30	180	111-22160	165	117-A121-125	194	117-B160-18-TI	199	117-C126-15	201	121-18224-50	214
111-21441-40	180	111-22171-12	166	117-A121-25	194	117-B160-21	197	117-C126-18	201	121-18224-55	214
111-21441-7	180	111-22171-4	166	117-A121-45	194	117-B160-21-TI	199	117-C126-18-TI	203	121-18224-60	214
111-21442-15	180	111-22171-7	166	117-A121-60	194	117-B165-18	197	117-C126-21	201	121-18224-65	214
111-21442-20	180	111-22171-9	166	117-A121-90	194	117-B165-21	197	117-C126-21-TI	203	121-18224-70	214
111-21442-25	180	111-22350	166	117-A125-125	195	117-C110-15	200	117-C126-23	201	121-18227	214
111-21442-7	180	111-22370	167	117-A125-25	195	117-C110-18	200	117-C126-23-TI	203	121-18229	214
111-21450-10	181	111-22385-4	167	117-A125-45	195	117-C110-18-TI	202	117-C130-19	201	121-18251-16	215
111-21450-11	181	111-22440-18	173	117-A125-60	195	117-C110-21	200	117-C130-23	201	121-18251-19	215
111-21450-12	181	111-22440-24	173	117-A125-90	195	117-C110-21-TI	202	117-C130-25	201	121-18251-22	215
111-21450-2	181	111-22442-19	173	117-B110-15	196	117-C110-23	200	117-C140-19	201	121-18255	215
111-21450-3	181	111-22442-24	173	117-B110-18	196	117-C110-23-TI	202	117-C140-23	201	121-19357-11	215
111-21450-4	181	111-22444	173	117-B110-21	196	117-C111-15	200	117-C140-25	201	121-19357-13	215
111-21450-5	181	111-22446	173	117-B110-23	196	117-C111-15-TI	202			121-19357-15	215
111-21450-6	181	111-22520-4	168	117-B111-15	196	117-C111-18	200	119		121-19357-18	215
111-21450-7	181	111-22522-4	169	117-B111-18	196	117-C111-18-TI	202	119-10915	206	121-19357-20	215
111-21450-8	181	111-22532	170	117-B111-21	196	117-C111-21	200	119-10928	206	121-19357-213	215
111-21450-9	181	111-22550-10	170	117-B120-15	196	117-C111-21-TI	202	119-10928-1	206	121-19357-215	215
111-21456-10	182	111-22550-8	170	117-B120-18	196	117-C111-23	200	119-28452	207	121-19357-218	215
111-21456-12	182	111-22563-3	172	117-B120-18-TI	198	117-C115-15	200	119-29187-50	207	121-19357-220	215
111-21456-2	182	111-22563-6	172	117-B120-21	196	117-C115-18	200	119-29187-60	207		
111-21456-4	182	111-22565-6	171	117-B120-21-TI	198	117-C115-18-TI	203	119-30010-15	208	125	
111-21456-6	182	111-22565-8	171	117-B120-23	196	117-C115-21	200	119-30022	208	125-19150-30	212
111-21456-8	182	111-22567-9	171	117-B120-23-TI	198	117-C115-21-TI	203	119-30025	208	125-19150-40	212
111-21460-10	182	111-22568-18	171	117-B120-25-TI	198	117-C115-23	200	119-50010-13	209	125-19150-50	212
111-21460-15	182	111-22569-18	171	117-B121-15	196	117-C115-23-TI	203	119-50010-14	209	125-19160	212
111-21460-20	182	111-22569-24	171	117-B121-18	196	117-C116-15	200	119-50010-3	209	125-19170	212
111-21477-10	184	111-22635	172	117-B121-18-TI	198	117-C116-18	200	119-50010-4	209		
111-21477-12	184	111-22860	174	117-B121-21	196	117-C116-21	200	119-50010-7	209	199	
111-21477-4	184	111-22861	174	117-B121-21-TI	198	117-C116-23	200	119-50012	209	199-60010	211
111-21477-6	184	111-22862	174	117-B121-23-TI	198	117-C120-15	200	119-50015	209	199-60020	211
111-21477-8	184	111-22863	174	117-B121-25-TI	198	117-C120-18	200	119-50022	210	199-60030	211
111-21501-1	183			117-B130-18	196	117-C120-18-TI	202	119-60001	210		
111-21501-2	183	117		117-B130-18-TI	198	117-C120-21	200	119-78900-1	211	413	
111-21501-3	183	117-A110-15	194	117-B130-21	196	117-C120-21-TI	202	119-78950	211	413-2500-2	213
111-21517-10	183	117-A110-18	194	117-B130-21-TI	198	117-C120-23	200			413-2502-125	213
111-21517-12	183	117-A110-21	194	117-B130-23	196	117-C120-23-TI	202	121		413-2502-85	213
111-21517-14	183	117-A111-15	194	117-B131-18	196	117-C121-15	200	121-18013-10	214	413-2504-125	213
111-21820	188	117-A111-18	194	117-B131-18-TI	198	117-C121-18	200	121-18013-4	214	413-2504-85	213
111-21825	189	117-A111-21	194	117-B131-21	196	117-C121-18-TI	202	121-18013-5	214		
111-21825-5	189	117-A112-15	194	117-B131-21-TI	198	117-C121-21	200	121-18013-6	214	415	
111-21920	189	117-A112-18	194	117-B140-18	197	117-C121-21-TI	202	121-18013-7	214	415-2020	213
111-21920-5	189	117-A112-21	194	117-B140-18-TI	199	117-C121-23	200	121-18013-8	214	415-2025-400	213
111-22140-4	169	117-A113-15	194	117-B140-21	197	117-C121-23-TI	202	121-18013-9	214		



DR. CLARENCE CRAFOORD, professor i thoraxkirurgi vid Karolinska institutet samt överläkare vid Sabbatsbergs sjukhus. En pionjär inom thoraxkirurgi som genomförde världens första operation av kärlmissbildning vid medfött hjärtfel. Utvecklade tillsammans med STILLE, bland annat pincetter och peanger som än idag bär hans namn.

DR. CLARENCE CRAFOORD, professor of thoracic surgery at the Karolinska Institute and Chief Physician at Sabbatsberg Hospital. A pioneer in thoracic surgery who conducted the world's first operation for vascular malformation of congenital heart defects. Developed in collaboration with STILLE forceps and artery forceps, which still bear his name.

Alfabetiskt register

Produktnamn	Sida	Produktnamn	Sida	Produktnamn	Sida	Produktnamn	Sida
A		A		A		A	
Adlercreutz STILLE pincett	56	Cooper STILLE operationssax	33	Gillquist-STILLE artroskopisugrör	206	Kocher STILLE peang	67
Adson STILLE anatomisk pincett	57	Cottle STILLE nässpekulum	158	Gipssåg STILLE	213	Kärilsax STILLE-Lund	41
Adson STILLE peang	73	Cottle STILLE osteotom	184	Gorney STILLE SuperCut XE ergonomisk Face-lift sax	46	Kärilsax STILLE SuperCut XE	40
Adson STILLE pincett	54	Cottle STILLE raspatorium	165	Gorney STILLE SuperCut XE Face-lift sax	46	Kärilsax STILLE SuperCut XE	40
Adson STILLE självhållande hake	156	Cottle STILLE septumlevatorium	170	Gougemejsel STILLE	186	König-STILLE nagelupplipningsax	35
Adson-Brown STILLE pincett	54	Cottle STILLE SuperCut XE nåssax	45	Gougemejsel STILLE	186		
Adson-Callison STILLE pincett	54	Crafoord STILLE peang	77	Gougetång STILLE	102	L	
Allis STILLE fattningstång	133	Crafoord-STILLE anatomisk pincett	58	Gougetång STILLE	104	Lambert-Kay STILLE aorta anastomosklämmare	127
Allis STILLE fattningstång	134	Crile STILLE peang	69	Gougetång STILLE	107	Lambotte STILLE miniosteotom	181
Alm STILLE hake	155	Crile STILLE peang	69			Lambotte STILLE osteotom	180
Anastomosklämmare STILLE	126	Crile-Wood STILLE gracil nålförare	87	H		Lambotte STILLE osteotom	180
Anatomisk pincett STILLE	57	Crile-Wood STILLE nålförare	86	Hake STILLE	146	Lambotte STILLE raspatorium	165
Anatomisk pincett STILLE	57	Cushing STILLE bittång	113	Halsey STILLE nålförare	85	Lambåhake Stille-Al Husseiny	143
Artrioskopikanylset STILLE	213			Halsted-Mosquito STILLE gracil peang	66	Langenbeck STILLE elevatorium	170
Artär- och ligaturklämmare STILLE	78	D		Halsted-Mosquito STILLE peang	66	Langenbeck STILLE hake	147
Aston STILLE SuperCut XE Face-lift sax	47	Dandy STILLE peang	74	Halsted-Mosquito STILLE peang	66	Leksell STILLE gougetång	105
Aufricht STILLE nåshake	148	Davis STILLE SuperCut XE Face-lift sax	47	Hammare STILLE	188	Leksell STILLE gougetång	106
		De Bakey STILLE kärpincett	61	Hammare STILLE	189	Leriche STILLE peang	70
B		De Bakey STILLE kärpincett	61	Hammare STILLE	89	Lexer STILLE osteotom	182
Babcock STILLE fattningstång	132	De Bakey STILLE kärpincett	61	Handosteotom STILLE	182	Ligaturklämmare STILLE-Ehrén	78
Baby Mayo STILLE dissektionssax	21	Deaver STILLE hake	149	Heiss STILLE peang	76	Lister STILLE TC bandagesax	50
Baby Metzenbaum STILLE Diamond SuperCut dissektionssax	23	DeBaKey STILLE aorta aneurysmklämmare	128	Hemostop STILLE	210	Littauer STILLE sutursax	51
Baby Metzenbaum STILLE dissektionssax	22	DeBaKey STILLE mikropincett	197	Hohmann STILLE elevatorium	171	Littler STILLE trådföringssax	49
Baby Metzenbaum STILLE SuperCut XE dissektionssax	23	DeBaKey STILLE mikropincett	197	Howarth STILLE näsraspatorium	167	Love STILLE nervhake	144
Baby Metzenbaum STILLE SuperCut XE ergonomisk dissektionssax	23	Derf STILLE nålförare	3			Love-Gruenwald STILLE bittång	113
Backhaus STILLE dukklämmare	131	Desmarres STILLE ögonlockshake	150	I		Luer-STILLE gougetång	103
Barron STILLE skalpellhandtag	209	Dissektionssax STILLE-Mayo	20	Instrumentbricka STILLE	211		
Benavbitare STILLE	98	Dissektionssax STILLE-Mayo SuperCut XE	21	Instrumentolja STILLE	211	M	
Benavbitare STILLE	98	Dissektor STILLE	173	Irispincett STILLE	60	Maier STILLE tvättång	135
Benavbitare STILLE	99	Doyen STILLE bukhake	151			Matarasso STILLE SuperCut XE ergonomisk Face-lift sax	48
Bengolea STILLE peang	72	DUO-GRIP nålförare STILLE-Frimand	87	J		Matarasso STILLE SuperCut XE Face-lift sax	48
Bergström-STILLE muskelbiopsi kanyl	207	Duval STILLE fattningstång	132	Jabaley STILLE dissektionssax	18	Mathieu STILLE nålförare	90
Beyer STILLE gougetång	100	E		Jabaley STILLE SuperCut XE dissektionssax	19	Mayo STILLE dissektionssax	19
Beyer STILLE gougetång	101	Elevatorium STILLE	172	Jabaley STILLE SuperCut XE ergonomisk dissektionssax	19	Mayo STILLE peanghängare	210
Björk-STILLE diatermipincetter	62	Ericsson-STILLE carotisklämmare	129	Jameson STILLE skjutmått	208	Mayo STILLE SuperCut XE dissektionssax	20
Björk-STILLE knutpincett	63	Ericsson-STILLE profunda arteria femoralis klämmare	130	Joseph STILLE hudhake	42	Mayo-Harrington STILLE operationssax	33
Boyd-STILLE tonsillsax	34	Extraktionstång STILLE	97	Joseph STILLE nåssax	42	Mayo-Harrington STILLE SuperCut XE operationssax	34
Brösthake STILLE	150			Joseph STILLE raspatorium	167	Mayo-Hegar STILLE kraftig nålförare	86
		F		Joseph STILLE SuperCut XE nåssax	42	Mayo-Hegar STILLE nålförare	85
C		Finochietto STILLE revbensspidare	157	K		Mayo-Noble STILLE dissektionssax	21
Carlens STILLE Tracheotomihake	154	Foerster STILLE ringtång	136	Kaye STILLE dissektionssax	18	McIndoe STILLE anatomisk pincett	57
Caspar STILLE bittång	115	Fomon STILLE nåssax	42	Kaye STILLE nålförare	91	Mejsel STILLE	185
Castroviejo STILLE skjutmått	208	Fomon STILLE rasp	174	Kaye STILLE SuperCut XE dissektionssax	18	Metzenbaum Stille Diamond SuperCut dissektionssax	27
Christophe-STILLE peang	68	Fomon STILLE SuperCut XE nåssax	44	Kelly STILLE peang	67	Metzenbaum STILLE dissektionssax	25
Cinelli STILLE osteotom	183	Frakturtråd STILLE	214	Kelly-Rankin STILLE peang	68	Metzenbaum Stille gracil Diamond SuperCut dissektionssax	25
Cobb STILLE raspatorium	164	Freer STILLE elevatorium	169	Kerrison STILLE laminektomistans	111	Metzenbaum STILLE gracil dissektionssax	24
Colonklämmare STILLE	118	G		Kerrison STILLE laminektomistans	112	Metzenbaum STILLE gracil SuperCut XE dissektionssax	24
Converse STILLE nålförare	91	Gillies STILLE hudhake	142	Kilner STILLE nålförare	83	Metzenbaum STILLE SuperCut XE dissektionssax	27
Converse STILLE nåshake	149	Gillies STILLE nålförare	84	Kirschner STILLE trådborr	215	Metzenbaum STILLE SuperCut XE ergonomisk dissektionssax	28
		Gillies STILLE pincett	54	Kleinert-Kutz STILLE hudhake	143	Metzenbaum Stille-Ekberg Diamond SuperCut	
				Kocher STILLE bukspatel	153		

Produktnamn	Sida
ergonomisk dissektionssax	29
Metzenbaum Stille-Ekberg gracil Diamond SuperCut	
ergonomisk dissektionssax	26
Metzenbaum Stille-Ekberg gracil SuperCut	
ergonomisk dissektionssax	26
Metzenbaum Stille-Ekberg SuperCut	
ergonomisk dissektionssax	28
Mikro klopincett STILLE	197
Mikrokärlsax STILLE SuperCut	194
Mikrokärlsax STILLE SuperCut	195
Mikro nålförare STILLE	200
Mikro nålförare STILLE	200
Mikro nålförare STILLE	200
Mikro nålförare STILLE	201
Mikro nålförare STILLE	201
Mikro ringpincett STILLE	197
Mikropincett STILLE	196
Mikropincett STILLE	196
Mikropincett STILLE	196
Mikrosax STILLE SuperCut	194
Mini tangential occlusionsklämmare STILLE	123
Mini universalklämmare STILLE	120
Mini universalklämmare STILLE	120
Mini-Hohmann STILLE elevatorium	171
Moberg STILLE hake	145
Mätsticka STILLE	208
N	
Neivert STILLE osteotom	183
Nervhake STILLE	144
New Orleans STILLE nålförare	88
Nålförare STILLE	89
Nålförare STILLE	89
Näselevatorium STILLE	169
Näsraspatorium STILLE	168
Nässax STILLE SuperCut XE	44
O	
Olivecrona STILLE peang	73
Olivecrona STILLE raspatorium	164
Olivecrona-STILLE durapincett	59
Olsen-Hegar STILLE nålförare	90
Oretorp-STILLE sond	206
Osteotom STILLE	178
Osteotom STILLE	178
Osteotom STILLE	179
Osteotom STILLE	179
Overholt STILLE peang	76

Produktnamn	Sida
P	
Palmer-STILLE benstift	214
Pean STILLE peang	66
Peck-Joseph STILLE nässax	43
Peck-Joseph STILLE SuperCut XE nässax	43
Perifer kärklämmare STILLE	125
Perman STILLE bukhake	152
Pincett STILLE	55
Pincett STILLE	55
Pincett STILLE	55
Pincett STILLE	55
Plattång STILLE	96
Pryl STILLE	187
R	
Ragnell Stille Diamond SuperCut dissektionssax	31
Ragnell STILLE dissektionssax	30
Ragnell STILLE hake	147
Ragnell STILLE operationssax	35
Ragnell STILLE raspatorium	166
Ragnell STILLE SuperCut XE dissektionssax	30
Ragnell STILLE SuperCut XE ergonomisk dissektionssax	32
Ragnell STILLE SuperCut XE ergonomisk ögonlockssax	17
Ragnell STILLE SuperCut XE ögonlockssax	17
Ragnell Stille-Ekberg Diamond SuperCut	
ergonomisk dissektionssax	31
Ragnell Stille-Ekberg SuperCut	
ergonomisk dissektionssax	31
Rapp-STILLE knuthållartång	92
Récamier STILLE uteruskyrett	162
Rees STILLE SuperCut XE Face-lift sax	48
Rengöringsborste STILLE	211
Rochester-Ochsner STILLE peang	71
Rochester-Ochsner STILLE peang	72
Rochester-Péan STILLE peang	70
Rochester-Péan STILLE peang	71
Ruskin-STILLE gougetång	102
Russian STILLE pincett	56
Ryder STILLE nålförare	88
S	
Satinsky STILLE tangential occlusionsklämmare	124
Sawtell STILLE peang	75
Schnidt STILLE peang	74
Schroeder STILLE klotång	137
Semb STILLE behållartång	108
Senn STILLE hake	148
Sims STILLE dissektionssax	22
Skalpellhandtag STILLE	209
Skalpellhandtag STILLE	209
Slev STILLE	163
Slev STILLE	163

Produktnamn	Sida
Sond STILLE	206
Spencer STILLE sutursax	50
Spiraltång Stille-Norell	134
Spurling STILLE bittång	114
Stevens Stille-Ekberg Diamond SuperCut	
ergonomisk tenotomisax	39
Stevens Stille-Ekberg SuperCut	
ergonomisk tenotomisax	39
Stevens-Stille Diamond SuperCut	
ergonomisk tenotomisax	38
Stevens-Stille Diamond SuperCut tenotomisax	37
Stevens-STILLE SuperCut tenotomisax	36
Stevens-STILLE SuperCut XE ergonomisk tenotomisax	38
Stevens-STILLE tenotomisax	36
Stolte STILLE tonsillelevatorium	172
Strandell STILLE hake	145
Ståltrådshållare STILLE	93
Ståltrådsroterare STILLE	93
Sutursax STILLE	50
T	
Thorek STILLE dissektionssax	32
Titan DeBakey STILLE mikropincett	199
Titan mikro ringpincett STILLE	199
Titan mikronålförare STILLE	202
Titan mikronålförare STILLE	203
Titan mikropincett STILLE	198
Titan mikropincett STILLE	198
Trådavbitare STILLE	109
Trådavbitare STILLE	109
Trådavbitare STILLE	110
Trådsåg STILLE-Gigli	212
U	
Universal STILLE ståltrådssax	51
Universalklämmare STILLE	121
Universalklämmare STILLE	122
Uppsala STILLE galltång	119
Uterusmanipulator STILLE	138
Uterussond STILLE	207
Vienna STILLE nässpekulum	158
Volkman STILLE hake	146

Produktnamn	Sida
W	
Waugh-Brophy STILLE anatomisk pincett	58
Waugh-Brophy STILLE isolerad diatermpincett	62
Waugh-Brophy STILLE isolerad diatermpincett	62
Waugh-Brophy STILLE pincett	56
Webster STILLE nålförare	83
Webster STILLE nålförare	84
Webster/Kleinert STILLE nålförare	84
Weitlaner STILLE hake	155
Wiberg STILLE raspatorium	166
Wiberg-STILLE benmärta	215
Wikström STILLE galltång	119
Z	
Zaufal-Jansen STILLE gougetång	101
Ö	
Ögonlockssax ergonomisk STILLE SuperCut XE	17
Ögonlockssax STILLE SuperCut XE	17
Ögonsax STILLE	16
Ögonsax STILLE	16
Ögonsax STILLE SuperCut XE	16

Alphabetical index | Alphabetisches Inhaltsverzeichnis | Indice alfabetico | Índice alfabético | アルファベット索引

Produktname	Sida	Produktname	Sida	Produktname	Sida	Produktname	Sida
A		C		E		J	
Adlercreutz STILLE Tissue Forceps	56	Boyd-STILLE Tonsil Scissors	34	Elevator STILLE	172	Jabaley STILLE Dissecting Scissors	18
Adson STILLE Artery Forceps	73	Breast Retractor STILLE	150	Ericsson-STILLE Carotid Clamp	129	Jabaley STILLE SuperCut XE Dissecting Scissors	19
Adson STILLE Dressing Forceps	57	C		Ericsson-STILLE Profunda Femoral Artery Clamps	130	Jabaley STILLE SuperCut XE Ergonomic Dissecting Scissors	19
Adson STILLE Self Retaining Retractor	156	Carlens STILLE Trachea Retractor	154	Extraction plier STILLE	97	Jameson STILLE Caliper	208
Adson STILLE Tissue Forceps	54	Caspar STILLE Rongeur	115	Eye Scissors STILLE	16	Joseph STILLE Nasal Scissors	42
Adson-Brown STILLE Tissue Forceps	54	Castroviejo STILLE Caliper	208	Eye Scissors STILLE	16	Joseph STILLE Respiratory	167
Adson-Callison STILLE Tissue Forceps	54	Chisel STILLE	185	Eye Scissors STILLE SuperCut XE	16	Joseph STILLE Skin Hook	142
Allis STILLE Intestinal Grasping Forceps	133	Christophe-STILLE Artery Forceps	68			Joseph STILLE SuperCut XE Nasal Scissors	42
Allis STILLE Intestinal Grasping Forceps	134	Cinelli STILLE Osteotome	183	F			
Alm STILLE Retractor	155	Cleaning Brush STILLE	211	Finochietto STILLE Rib Spreader	157	K	
Anastomosis Clamp STILLE	126	Cobb STILLE Raspatory	164	Flap Retractor STILLE-Al Husseiny	143	Kaye STILLE Dissecting Scissors	18
Artery and Ligature Clamp STILLE	78	Colon Clamp STILLE	118	Flat pliers STILLE	96	Kaye STILLE Needle holder	91
Arthroscopy Cannula Set STILLE	213	Converse STILLE Nasal Retractor	149	Foerster STILLE Sponge Holding Forceps	136	Kaye STILLE SuperCut XE Dissecting Scissors	18
Aston STILLE SuperCut XE Face-lift scissors	47	Converse STILLE Needle holder	91	Fomon STILLE Nasal Scissors	42	Kelly STILLE Artery Forceps	67
Aufricht STILLE Nasal Retractor	148	Cooper STILLE Operating Scissors	33	Fomon STILLE Rasp	174	Kelly-Rankin STILLE Artery Forceps	68
Awl STILLE	187	Cottle STILLE Nasal Speculum	158	Fomon STILLE SuperCut XE Nasal Scissors	44	Kerrison STILLE Laminectomy Punch	111
		Cottle STILLE Osteotome	184	Fracture Staple Wiberg-STILLE	215	Kerrison STILLE Laminectomy Punch	112
B		Cottle STILLE Raspatory	165	Freer STILLE Elevator	169	Kilner STILLE Needle holder	83
Babcock STILLE Intestinal Grasping Forceps	132	Cottle STILLE Septum Elevator	170			Kirschner STILLE Wire Drill	215
Baby Mayo STILLE Dissecting Scissors	21	Cottle STILLE SuperCut XE Nasal Scissors	45	G		Kleinert-Kutz STILLE Skin Hook	143
Baby Metzenbaum STILLE Diamond SuperCut		Crafoord STILLE Artery Forceps	77	Gillies STILLE Needle Holder	84	Kocher STILLE Abdominal Spatula	153
Dissecting Scissors	23	Crafoord-STILLE Dressing Forceps	58	Gillies STILLE Skin Hook	142	Kocher STILLE Artery Forceps	67
Baby Metzenbaum STILLE Dissecting Scissors	22	Crile STILLE Artery Forceps	69	Gillies STILLE Tissue Forceps	54	König-STILLE Nail-splitting Scissors	35
Baby Metzenbaum STILLE SuperCut XE		Crile STILLE Artery Forceps	69	Gillquist-STILLE Arthroscopy Suction Tube	206		
Dissecting Scissors	23	Crile-Wood STILLE Delicate Needle holder	87	Gorney STILLE SuperCut XE Ergonomic Face-lift scissors	46	L	
Baby Metzenbaum STILLE SuperCut XE		Crile-Wood STILLE Needle holder	86	Gorney STILLE SuperCut XE Face-lift scissors	46	Lambert-Kay STILLE Aortic-Anastomosis Clamp	127
Ergonomic Dissecting Scissors	23	Cushing STILLE Rongeur	113	Gouge STILLE	186	Lambotte STILLE Mini Osteotome	181
Backhaus STILLE Towel Clamps	131			Gouge STILLE	186	Lambotte STILLE Osteotome	180
Barron STILLE Scalpel Handle	209	D				Lambotte STILLE Osteotome	180
Bengolea STILLE Artery Forceps	72	Dandy STILLE Artery Forceps	74	H		Lambotte STILLE Raspatory	165
Bergström-STILLE Muscle biopsy Cannula	207	Davis STILLE SuperCut XE Face-lift Scissors	47	Halsey STILLE Needle Holder	85	Langenbeck STILLE Elevator	170
Beyer STILLE Bone Rongeur	100	De Bakey STILLE Vascular Forceps	61	Halsted-Mosquito STILLE Artery Forceps	66	Langenbeck STILLE Retractor	147
Beyer STILLE Bone Rongeur	101	De Bakey STILLE Vascular Forceps	61	Halsted-Mosquito STILLE Artery Forceps	66	Leksell STILLE Bone Rongeur	105
Björk-STILLE Diathermy Forceps	62	De Bakey STILLE Vascular Forceps	61	Halsted-Mosquito STILLE delicate Artery Forceps	66	Leksell STILLE Bone Rongeur	106
Björk-STILLE Knot-Holding Forceps	63	Deaver STILLE Retractor	149	Hand Osteotome STILLE	182	Leriche STILLE Artery Forceps	70
Blepharoplasty Scissors STILLE SuperCut XE	17	DeBakey STILLE Aortic-Aneurysm Clamp	128	Heiss STILLE Artery Forceps	76	Lexer STILLE Osteotome	182
Blepharoplasty Ergonomic Scissors STILLE SuperCut XE	17	Derf STILLE Needle holder	83	Hemostop STILLE	210	Ligature Clamp STILLE-Ehrén	78
Bone curette STILLE	163	Desmarres STILLE Eye-lid Retractor	150	Hohmann STILLE Elevator	171	Lister STILLE TC Bandage Scissors	50
Bone curette STILLE	163	Diamond Metzenbaum STILLE-Ekberg SuperCut		Howarth STILLE Nasal Raspatory	167	Littauer STILLE Suture scissors	51
Bone Cutting Forceps STILLE	98	Ergonomic Dissecting Scissors	29			Littler STILLE Suture carrying scissors	49
Bone Cutting Forceps STILLE	98	Dissecting Scissors STILLE-Mayo	20	I		Love STILLE Nerve Hook	144
Bone Cutting Forceps STILLE	99	Dissecting Scissors STILLE-Mayo SuperCut XE	21	Instrument Oil STILLE	211	Love-Gruenwald STILLE Rongeur	113
Bone Nail Palmer-STILLE	214	Dissector STILLE	173	Instrument Sterilization Tray STILLE	211	Luer-STILLE Bone Rongeur	103
Bone Rongeur STILLE	102	Doyen STILLE Abdominal Retractor	151	Iris Forceps STILLE	60		
Bone Rongeur STILLE	104	Dressing Forceps STILLE	57	IUD Forceps STILLE-Norell	134		
Bone Rongeur STILLE	107	Dressing Forceps STILLE	57				
Bone Wire STILLE	214	DUO-GRIP Needle holder STILLE-Frimand	87				
		Duval STILLE Intestinal Grasping Forceps	132				

Produkttnamn	Sida
M	
Maier STILLE Sponge Holding Forceps	135
Mallet STILLE	188
Mallet STILLE	189
Mallet STILLE	189
Matarasso STILLE SuperCut XE Ergonomic Face-lift scissors	48
Matarasso STILLE SuperCut XE Face-lift scissors	48
Mathieu STILLE Needle holder	90
Mayo STILLE Dissecting Scissors	19
Mayo STILLE Safety Pin	210
Mayo STILLE SuperCut XE Dissecting Scissors	20
Mayo-Harrington STILLE Operating Scissors	33
Mayo-Harrington STILLE SuperCut XE Operating Scissors	34
Mayo-Hegar STILLE Heavy Needle holder	86
Mayo-Hegar STILLE Needle holder	85
Mayo-Noble STILLE Dissecting Scissors	21
McIndoe STILLE Dressing Forceps	57
Metzenbaum STILLE Delicate Diamond SuperCut Dissecting Scissors	25
Metzenbaum STILLE Delicate Dissecting Scissors	24
Metzenbaum STILLE Delicate SuperCut XE Dissecting Scissors	24
Metzenbaum STILLE Diamond SuperCut Dissecting Scissors	27
Metzenbaum STILLE Dissecting Scissors	25
Metzenbaum STILLE SuperCut XE Dissecting Scissors	27
Metzenbaum STILLE SuperCut XE Ergonomic Dissecting Scissors	28
Metzenbaum STILLE-Ekberg Delicate Diamond SuperCut Ergonomic Dissecting Scissors	26
Metzenbaum STILLE-Ekberg Delicate SuperCut Ergonomic Dissecting Scissors	26
Metzenbaum STILLE-Ekberg SuperCut Ergonomic Dissecting Scissors	28
Micro DeBakey STILLE Forceps	197
Micro DeBakey STILLE Forceps	197
Micro Forceps STILLE	196
Micro Forceps STILLE	196
Micro Forceps STILLE	196
Micro Needle Holder STILLE	200
Micro Needle Holder STILLE	200
Micro Needle Holder STILLE	200
Micro Needle Holder STILLE	201
Micro Needle Holder STILLE	201
Micro Ring Forceps STILLE	197
Micro Scissors STILLE SuperCut	194
Micro Tissue Forceps STILLE	197
Micro Vascular Scissors STILLE SuperCut	194
Micro Vascular Scissors STILLE SuperCut	195
Mini Multi-purpose clamp STILLE	120

Produkttnamn	Sida
Mini Multi-purpose clamp STILLE	120
Mini Tangential Occlusion Clamp STILLE	123
Mini-Hohmann STILLE Elevator	171
Moberg STILLE Retractor	145
Multi-purpose clamp STILLE	121
Multi-purpose clamp STILLE	122
N	
Nasal Elevator STILLE	169
Nasal Raspatory STILLE	168
Nasal Scissors STILLE SuperCut XE Needle holder STILLE	44
Needle holder STILLE	89
Needle holder STILLE	89
Neivert STILLE Osteotome	183
Nerve Hook STILLE	144
New Orleans STILLE Needle holder	88
O	
Olivecrona STILLE Artery Forceps	73
Olivecrona STILLE Raspatory	164
Olivecrona-STILLE Dura Forceps	59
Olsen-Hegar STILLE Needle holder	90
Oretorp-STILLE Probe	206
Osteotome STILLE	178
Osteotome STILLE	178
Osteotome STILLE	179
Osteotome STILLE	179
Overholt STILLE Dissecting Forceps	76
P	
Pean STILLE Artery Forceps	66
Peck-Joseph STILLE Nasal Scissors	43
Peck-Joseph STILLE SuperCut XE Nasal Scissors	43
Peripheral Vascular Clamp STILLE	125
Perman STILLE Abdominal Retractor	152
Plaster Cast Remover STILLE	213
Probe STILLE	206
R	
Ragnell STILLE Diamond SuperCut Dissecting Scissors	31
Ragnell STILLE Dissecting Scissors	30
Ragnell STILLE Operating Scissors	35
Ragnell STILLE Raspatory	166
Ragnell STILLE Retractor	147
Ragnell STILLE SuperCut XE Blepharoplasty Scissors	17
Ragnell STILLE SuperCut XE Dissecting Scissors	30
Ragnell STILLE SuperCut XE Ergonomic Blepharoplasty Scissors	17
Ragnell STILLE SuperCut XE Ergonomic Dissecting Scissors	32
Ragnell STILLE-Ekberg Diamond SuperCut Ergonomic Dissecting Scissors	31

Produkttnamn	Sida
Ragnell STILLE-Ekberg SuperCut Ergonomic Dissecting Scissors	31
Rapp-STILLE Knot-holding Forceps	92
Récamier STILLE Uterine curette	162
Rees STILLE SuperCut XE Face-lift scissors	48
Retractor STILLE	146
Rochester-Ochsner STILLE Artery Forceps	71
Rochester-Ochsner STILLE Artery Forceps	72
Rochester-Péan STILLE Artery Forceps	70
Rochester-Péan STILLE Artery Forceps	71
Ruler STILLE	208
Ruskin-STILLE Bone Rongeur	102
Russian STILLE Tissue Forceps	56
Ryder STILLE Needle holder	88
S	
Satinsky STILLE Tangential Occlusion Clamp	124
Sawtell STILLE Artery Forceps	75
Scalpel Handle STILLE	209
Scalpel Handle STILLE	209
Schmidt STILLE Artery Forceps	74
Schroeder STILLE Tenaculum Forceps	137
Semb STILLE Bone Holding Forceps	108
Senn STILLE Retractor	148
Sims STILLE Dissecting Scissors	22
Spencer STILLE Suture scissors	50
Spurling STILLE Rongeur	114
Stevens STILLE-Ekberg Diamond Ergonomic SuperCut Tenotomy Scissors	39
Stevens STILLE-Ekberg Ergonomic SuperCut Tenotomy Scissors	39
Stevens-STILLE Diamond Ergonomic SuperCut Tenotomy Scissors	38
Stevens-STILLE Diamond SuperCut Tenotomy Scissors	37
Stevens-STILLE SuperCut Tenotomy Scissors	36
Stevens-STILLE SuperCut XE Ergonomic Tenotomy Scissors	38
Stevens-STILLE Tenotomy Scissors	36
Stolte STILLE Tonsil Elevator	172
Strandell STILLE Retractor	145
Suture scissors STILLE	50
T	
Thorek STILLE Dissecting Scissors	32
Tissue Forceps STILLE	55
Tissue Forceps STILLE	55
Tissue Forceps STILLE	55
Tissue Forceps STILLE	55
Titanium Micro DeBakey STILLE Forceps	199
Titanium Micro Forceps STILLE	198
Titanium Micro Forceps STILLE	198
Titanium Micro Needle Holder STILLE	202

Produkttnamn	Sida
Titanium Micro Needle Holder STILLE	203
Titanium Micro Ring Forceps STILLE	199
U	
Universal STILLE Wire Cutting scissors	51
Uppsala STILLE Gall Duct Clamp	119
Uterine Manipulator STILLE	138
Uterine Sound STILLE	207
V	
Vascular Scissors STILLE-Lund	41
Vascular Scissors STILLE SuperCut XE	40
Vascular Scissors STILLE SuperCut XE	40
Vienna STILLE Nasal Speculum	158
Volkman STILLE Retractor	146
W	
Waugh-Brophy STILLE Dressing Forceps	58
Waugh-Brophy STILLE insulated Diathermy Forceps	62
Waugh-Brophy STILLE insulated Diathermy Forceps	62
Waugh-Brophy STILLE Tissue Forceps	56
Webster STILLE Needle holder	83
Webster STILLE Needle holder	84
Webster/Kleinert STILLE Needle holder	84
Weitlaner STILLE Retractor	155
Wiberg STILLE Raspatory	166
Wikström STILLE Gall Duct Clamp	119
Wire Cutter STILLE	109
Wire Cutter STILLE	109
Wire Cutter STILLE	110
Wire Holding Forceps STILLE	93
Wire Saw STILLE-Gigli	212
Wire Twisting Forceps STILLE	93
Z	
Zaufal-Jansen STILLE Bone Rongeur	101

Garanti | Guarantee | Garantie | Garanzia | Garantie

Hanteringsanvisningar

Följande råd och skötselansvisningar har framtagits för att ni skall få största möjliga nytta och glädje av samt optimal livslängd på kirurgiska instrument från STILLE. Dessutom är villkoret för STILLES garantiåtgående att instrumentet hanteras och sköts i enlighet med nedan angivna instruktioner.

1. Hantera instrument varsamt, detta gäller instrument i allmänhet och mikroinstrument i synnerhet. Ytbehandlade instrument (STILLE Diamond) kan vara extra känsliga i samband med diatermi. Undvik direkt kontakt med diatermi-elektrod då detta kan medföra skador på ytskiktet.
2. Rengör instrumentet manuellt eller maskinellt så fort som möjligt efter användning. Låt ej föroreningar torka in på instrumentet. Rengöring med metoder som innehåller väteperoxid rekommenderas ej på instrument med svartkrom. Dessa kan bli flammiga, dock påverkas inte funktionen.
3. Förvara inte instrument i fuktig miljö längre än absolut nödvändigt, t.ex. i avvaktan på transport till sterilcentral. Använd endast för ändamålet avsedda lösningar.
4. Låt inte instrument ligga i mekanisk spänning, t.ex. knäppta eller intrasslade i andra instrument. Det föreligger då risk för spänningskorrosion. Instrument med knäppen skall lämnas öppna. Lägg de tyngsta instrumenten underst med de lättare ovanpå. Mikrokirurgiska instrument skall aldrig läggas ovanpå varandra.
5. Vatten och vattenånga för rengöring, desinfektion och autoklavering kan innehålla salter, metaller och mineraler, vilka kan orsaka korrosion och missfärgningar. Kontrollera vattenkvaliteten. Hårt vatten bör mjukgöras. Slutsköljning av instrument med demineraliserat vatten rekommenderas.
6. Följ alltid fabrikantens anvisningar vid användning av diskdesinfektor och diskmedel. Använd ett diskmedel med pH-värde mellan 8-10,5 i korrekt dosering enligt tillverkarens anvisningar. Förvara inte instrumentet under längre tid i lösningen än vad fabrikanten angivit. Skölj, helst med demineraliserat vatten. Torka instrumentet omedelbart. Följ standard EN-ISO 15883 samt nationella riktlinjer – använd endast validerad process för rengöring och desinfektion.
7. Använd endast för ändamålet avsedda desinfektionslösningar vid manuell rengöring. Var noga med att följa fabrikantens anvisningar vad gäller dosering och tid. Förvara inte instrumentet under längre tid i lösningen än vad fabrikanten angivit. Skölj, helst med demineraliserat vatten. Torka instrumentet omedelbart.
8. Vid användning av ultraljud för rengöring skall instrumentet vara helt täckt med vätska samt vara öppet. Instrument med ytbeläggning skall ej rengöras i ultraljud. Skölj, gärna med demineraliserat vatten. Torka noga. Följ fabrikantens anvisningar.
9. Kontrollera instrument med avseende på föroreningar, repor, missfärgningar, sprickor, korrosion.
10. Kontrollera varje enskilt instruments funktion.
11. Använd endast instrumentborstar. Stålull får aldrig användas.
12. Anolj instrument, på ställen där metall nöter mot metall, efter varje användning. Anoljning görs lämpligen omedelbart före sterilisering. Använd gärna STILLES instrumentolja. Oljan måste ha en flampunkt över 135°C. Använd endast ringa mängd olja på ytor som möts vid funktion (saxskär, boxlås, skruvar, spärrlås). Torka bort överflödiga olja för undvikande av kladdiga instrument samt fettfläckar på autoklaveringsförpackningen.

13. Följ noga fabrikantens anvisningar vid autoklavering. Var noga med att inte packa instrumenten hårt. Instrument skall autoklaveras "öppna" för att ångan skall kunna nå alla delar av ett instrument.
14. Hetluftssterilisering rekommenderas ej. Hög temperatur påverkar metall-len.
15. Väteperoxidsterilisering rekommenderas ej för svartkromade instrument. Dessa kan bli flammiga, dock påverkas inte funktionen.
16. Nya instrument måste rengöras, inspekteras, anoljas samt steriliseras före första användning.
17. Använd endast professionell reparatör/verkstad för service och reparationer. T.ex. måste Super Cut -saxar slipas på ett speciellt sätt, annars är det lätt att förstöra eggen. Vid felaktigt utförd reparation/ service gäller ej STILLES garantiåtgående!

Garanti

Med avseende på utförande och material lämnar vi garanti på kirurgiska handinstrument av egen tillverkning. I en period av 30 år efter inköp, ersätter eller reparerar vi kostnadsfritt ett skadat instrument om skadan finnes orsakad av fel i utförande eller material. Normal förslitning omfattas inte av vår garanti. Utfästelsen gäller under förutsättning att att instrumentet används för avsett ändamål samt vårdas och lagras korrekt och att skriftlig anmälan görs till STILLE inom 30 dagar från skadetillfället.

Instrument Care

The following advice and care instructions have been drawn up to achieve the maximum utilization and optimal length of life from STILLE's surgical instruments. In addition, one of the conditions of STILLE's guarantee commitments is that instruments are handled and cared for according to the instructions stated below.

1. Handle instruments carefully. This applies to instruments in general but particularly to micro instruments. Coated STILLE Diamond instruments may be sensitive for diathermy. Avoid direct contact with diathermy electrode as this may cause damages to the surface coating.
2. Clean instruments manually or by machine as soon as possible after use. Do not allow contaminants to dry on instruments. Cleaning with any method containing hydrogen peroxide is not recommended for black chrome plated instruments (eg SuperCut scissors).
3. If cleaning must be delayed, store the instruments in an appropriate solution. Do not just use water.
4. Do not allow instruments to remain under mechanical stress since this increases the risks for corrosion and damage. Instruments must not be allowed to lie in a disorganized manner. Instruments with ratchets must be left open. The heaviest instruments on the bottom with lighter instruments above. Microsurgical instruments should never be laid on top of each other.

5. Water and steam used for cleaning, disinfection and auto-claving may contain salts, metals and minerals that can cause corrosion and discoloration. Check the quality of the water; hard water should be softened. Final rinsing of instruments with demineralized water is recommended.
6. Always follow the manufacturer's instructions when using disinfectants and detergents. Use a detergent with a pH-value between 8-10,5 in correct dosage according to the manufacturer's instructions. Do not store the instrument in the solution longer than indicated by the manufacturer. Rinse, preferably with demineralized water. Dry the instrument immediately. Follow standard EN-ISO 15883 and national guidelines – only use validated machine cleaning and disinfection processes.
7. Only use disinfection solutions intended for this purpose. Follow the manufacturer's instructions. Rinse, ideally with demineralized water. Dry the instruments.
8. When using ultrasound for cleaning, instruments should be opened and completely covered with cleaning solution. Coated instruments should not be cleaned in ultrasound. Rinse, ideally with demineralized water. Dry carefully. Follow the manufacturer's instructions.
9. Check instruments for contaminants, scratches, discoloration, cracks and corrosion.
10. Check the function of each individual instrument.
11. Use only instrument brushes. Steel wool should never be used.
12. After the cleaning process, lubricate the instruments where metal is in contact with metal. Use preferably STILLE instrument oil. The oil must have a flashpoint above 135 °C. Use only small amounts of oil on surfaces that are in contact during function (scissors edges, box locks, screws). Clean off excess oil to avoid oily instruments and oily stains on autoclave packaging. If a water-soluble lubricant is used instead of instrument oil, the solution should be diluted with demineralized water. Follow the manufacturer's instructions.
13. Follow the manufacturer's instructions for autoclaving. Instruments should be autoclaved open to allow steam to gain access to all parts of the instruments.
14. Hot air sterilisation is not recommended, as high temperature will affect the metal.
15. Hydrogen peroxide sterilisation is not recommended for black chrome plated instruments. These can become stained although function will not be affected.
16. New instruments must be cleaned, inspected, lubricated and sterilised before they are used for the first time.
17. Use only a professional instrument engineer/workshop for service and repairs. For example, Super Cut scissors must be ground in a special way otherwise the edges may be destroyed. If repairs/service are incorrectly carried out, STILLE's guarantee commitments no longer apply!

Guarantee

Surgical hand instruments manufactured by STILLE carry a guarantee in respect of materials and workmanship. For a period of 30 years after purchase, we will replace or repair a damaged instrument free of charge if the damage is found to have been caused by a defect in materials or workmanship. The guarantee is conditional on the instrument being used for the purpose intended, is cared for and stored correctly and that any claims are made in writing within 30 days of the damage occurring.

Gebrauchsanweisungen

Die folgenden Ratschläge und Gebrauchsanleitungen haben wir für Sie gemacht, damit Sie den grösstmöglichen Nutzen und Freude, sowie eine optimale Lebensdauer an chirurgische Instrumente von STILLE haben werden. Unsere Garantie ist auch mit der Bedingung verbunden, dass unsere Instrumente nach unseren Instruktionen behandelt und gepflegt werden.

1. Gebrauchen Sie die Instrumente mit Vorsicht, ganz besonders die Mikroinstrumente. Die beschichteten STILLE Diamond Instrumente können empfindlich bei der Anwendung von HF-Chirurgie reagieren. Vermeiden Sie den direkten Kontakt mit der Diathermie-Elektrode, da die Oberflächenbeschichtung der Instrumente beschädigt werden könnte.
2. Beseitigen Sie den Schmutz, manuell oder maschinell, direkt nach Gebrauch. Lassen Sie den Schmutz nie in das Instrument eintrocknen. Für schwarz verchromte Instrumente (z. B. SuperCut-Scheren) wird eine Reinigung mit Wasserstoffperoxid nicht empfohlen.
3. Lassen Sie die Instrumente nie länger als notwendig in feuchten Zustand liegen, z.B. beim Abwarten auf Transport zur Sterilzentrale. Benützen Sie nur die für das Instrument bestimmten Desinfektionsmittel.
4. Lassen Sie die Instrumente nicht in mechanischer Spannung, z.B. zusammengespannt oder mit anderen Instrumenten durcheinander liegen. Es kann sonst zu Spannungskorrosion kommen. Legen Sie die schwersten Instrumente nach unten und die leichteren oben drauf. Mikrochirurgische Instrumente dürfen niemals aufeinander liegen.
5. Wasser und Wasserdampf für Reinigung, Desinfektion und Sterilisierung können Salze, Metalle und Minerale enthalten die Korrosion und Verfärbungen verursachen können. Kontrollieren Sie die Wasserqualität. Hartes Wasser muss enthärtet werden. Für die Schlusspülung des Instrumentes empfehlen wir demineralisiertes Wasser.
6. Folgen Sie immer den Anweisungen des Herstellers bei Verwendung von Desinfektions- und Reinigungsautomaten, sowie beim Spülmittel. Verwenden Sie ein Reinigungsmittel mit einem pH-Wert von 8 - 10,5. Dosierungsangaben des Herstellers beachten! Die Instrumente dürfen nicht länger als vom Hersteller angegeben in der Lösung liegen. Das Spülen sollte mit vollentsalztem Wasser erfolgen. Trocknen Sie das Instrument sofort. Richten Sie sich nach dem EN-ISO 15883 Standard und den nationalen Vorschriften - verwenden Sie nur validierte maschinelle Reinigungs- und Desinfektionsverfahren.
7. Benützen Sie nur die für das Instrument vorgeschriebene Desinfektionslösung bei manueller Reinigung. Richten Sie nach den Anweisungen des Herstellers wegen Dosierung und Zeit. Die Instrumente dürfen nicht länger als vom Hersteller angegeben in der Lösung liegen. Spülen Sie am besten mit demineralisiertem Wasser. Trocknen Sie das Instrument hinterher.
8. Bei Ultraschallbehandlung muss das Instrument ganz in der Lösung und offen liegen. Beschichtete Instrumente dürfen nicht mit Ultraschall gereinigt werden. Spülen Sie mit demineralisiertem Wasser nach. Seien Sie sorgfältig beim Trocknen. Befolgen Sie die Anweisungen des Herstellers.
9. Kontrollieren Sie das Instrument auf Schmutz, Risse, Verfärbungen, Brüche und Korrosion.
10. Kontrollieren Sie jede einzelne Funktion des Instrumentes.
11. Bei der Reinigung verwenden Sie nur besondere für Instrumente geeignete Bürsten. Stahlwolle darf nie gebraucht werden. Es kann sonst zu Rissen und Eisenspänen auf dem Instrument kommen, was zur Korrosion führen kann.
12. Ölen Sie das Instrument leicht ein an Stellen, wo sich das Metall trifft (z.B. Scherenblätter, Box-Schlösser, Schrauben, Rasten) nach jedem Gebrauch. Die Einölung wird am besten vor der Sterilisierung vorgenommen. Wir empfehlen die Verwendung von Instrumentenöl von STILLE. Das Öl muss einen Entflammbarkeitsgrad von über 135 Grad Celsius haben. Trocknen Sie überflüssiges Öl auf, um schmierige Instrumente und Fettflecke auf den Steril-Verpackungen zu vermeiden.

13. Folgen Sie den Anweisungen des Herstellers sehr genau bei der Sterilisierung. Es ist wichtig das man die Instrumente nicht zu hart packt. Die Instrumente sollen in offenem Zustand sterilisiert werden, damit der Dampf an alle Teile des Instrumentes kommt.
14. Wir empfehlen keine Heissluftsterilisierung. Die hohen Temperaturen schaden dem Metall.
15. H₂O₂ Sterilisierung empfehlen wir nicht für schwarzverchromte Instrumente. Sie können flammig werden. Die Funktion wird dagegen nicht beeinträchtigt.
16. Neue Instrumente müssen gereinigt, kontrolliert, eingölt und sterilisiert werden vor dem ersten Gebrauch.
17. Für Service und Reparaturen machen Sie nur von professionellen Reparateuren/Werkstätten Gebrauch. Z.B. müssen Super Cut-Scheren speziell geschliffen werden, damit die Schneide nicht zerstört wird. Bei falsch ausgeführter Reparatur/Service gilt nicht die STILLE-Garantie.

Garantie

Wir übernehmen, auf Ausführung und Material von chirurgischen Instrumenten eigener Herstellung eine Garantie von 30 Jahren d.h., wir ersetzen oder reparieren kostenlos beschädigte Instrumente, bei denen die Ausführung oder das Material fehlerhaft ist. Diese Garantie erstreckt sich nicht auf den normalen Verschleiss. Die Garantieverpflichtung ist gültig unter der Voraussetzung, dass die Instrumente für vorgesehenen Zweck verwendet und fachgemäss gepflegt werden, sowie dass eingetretener Schaden uns innerhalb von 30 Tagen schriftlich mitgeteilt wird.

Trattamento degli strumenti chirurgici

I seguenti consigli e prescrizioni permettono di ottenere le migliori prestazioni e una lunga durata degli strumenti chirurgici STILLE. La garanzia STILLE è valida solo se vengono rispettate le istruzioni indicate.

1. Trattare tutti gli strumenti chirurgici con cura, in particolare gli strumenti per microchirurgia.
2. Pulire lo strumento immediatamente dopo l'utilizzo, a mano o meccanicamente. Non permettere alle impurità di indurire sugli strumenti. Non utilizzare prodotti contenenti perossido di idrogeno per la pulizia di strumenti con cromatura nera (ad esempio forbici SuperCut).
3. Non lasciare gli strumenti in ambiente umido più di quanto sia necessario, ad es. in attesa di essere trasportati al centro di sterilizzazione. Usare soluzioni appropriate, non acqua.
4. Per evitare il rischio di corrosione per tensione, non sottoporre lo strumento a tensione meccanica: in stato chiuso o intricato con altri strumenti. Strumenti a cremagliera devono rimanere aperti. Posare gli strumenti leggeri sopra quelli più pesanti. Gli strumenti per microchirurgia vanno sistemati uno vicino a l'altro.
5. Acqua e vapore utilizzato per la pulitura, la disinfezione e nell'autoclave possono contenere sali, metalli e minerali, i quali possono provocare corrosione e colorazioni. Verificare le caratteristiche dell'acqua. L'acqua che contiene una concentrazione troppo elevata di sali e di cloro deve essere filtrata e trattata. Si consiglia l'uso di acqua demineralizzata, soprattutto per la risciacquatura finale.

6. All'uso di prodotti per la disinfezione e la pulitura rispettare sempre le prescrizioni del produttore. Utilizzare un detergente con pH 8-10,5, dosaggio secondo le istruzioni del produttore. Non lasciare lo strumento nella soluzione più a lungo di quanto indicato dal fabbricante. Risciacquare, preferibilmente utilizzando acqua demineralizzata. Asciugare immediatamente.
7. Per la pulitura manuale usare unicamente soluzioni disinfettanti prescritte. Seguire attentamente le istruzioni per quanto riguarda la dose e la durata. Non lasciare gli strumenti nella soluzione più a lungo di quanto prescritto. Sciacquare con acqua demineralizzata e asciugare immediatamente.
8. Per la pulitura ad ultrasuoni lo strumento deve essere aperto e completamente immerso nella soluzione. Gli strumenti rivestiti non devono essere puliti ad ultrasuoni. Risciacquare con acqua demineralizzata e provvedere ad un'asciugatura completa e immediata.
9. Controllare che non ci siano residui, scalfitture, scolorimenti, fessure o macchie di corrosione sullo strumento.
10. Controllare il funzionamento di ogni strumento individualmente.
11. Usare unicamente spazzole morbide per strumenti - mai spugne o spazzole metalliche
12. Lubrificare lo strumento dopo ogni uso, nei punti di contatto tra le parti metalliche, immediatamente prima della sterilizzazione. Si consiglia olio STILLE per strumenti. In ogni caso si deve usare olio con punto d'infiammabilità superiore a 135 ° C. È sufficiente una goccia sulle superficie a contatto (filo delle forbici, cerniere ad incastro, fermagli, vite e tacche d'arresto). Rimuovere l'olio eccessivo per evitare strumenti grassi e macchie sul materiale d'imballaggio per l'autoclave.
13. Rispettare scrupolosamente le prescrizioni del costruttore degli sterilizzatori. Non imballare troppo forte. Gli strumenti devono essere aperti durante la sterilizzazione, permettendo al vapore di raggiungere tutte le parti dello strumento.
14. Sconsigliamo sterilizzazione a secco. Temperature alte possono alterare la struttura del metallo.
15. La sterilizzazione con acqua ossigenata non è consigliabile per strumenti cromati di nero. Detta procedura non compromette la funzione, ma le superficie nere si scoloriscono.
16. Strumenti nuovi devono essere puliti, controllati, oliati e sterilizzati prima del primo uso.
17. Riparazioni e manutenzione devono essere eseguite da professionali. Per esempio le forbici Super Cut (una lama da forcice e una lama da coltello) devono essere affilate in modo speciale per non rovinare il filo. La garanzia STILLE non è valida per riparazioni effettuate in modo errone.

Garanzia

Lo strumentario chirurgico della nostra propria produzione è coperto da una garanzia di 30 (Trenta) anni contro qualsiasi difetto di fabbricazione o di qualità del materiale usato. Ci impegniamo a ripararlo o a rimpiazzarlo a nostre spese, sempre se è un difetto di produzione o di materiale. La garanzia non copre il logoramento normale, neppure difetti dovuti a mancata manutenzione. Questo impegno è valevole a condizione che gli strumenti siano usati per lo scopo previsto e che siano custoditi e mantenuti in modo professionale, e che il reclamo per iscritto ci pervenga entro 30 giorni a partire dalla data di constatazione del guasto.

Tratamiento del instrumental quirúrgico

Hemos desarrollado los siguientes consejos e instrucciones de mantenimiento para que Ud. obtenga el mayor rendimiento y duración de los instrumentos quirúrgicos de STILLE. Asimismo, el compromiso de garantía de STILLE sólo es válido si el instrumento se utiliza y cuida según las instrucciones indicadas a continuación.

1. Trate el instrumento con cuidado. Este punto es aplicable a todos los instrumentos en general y a los microinstrumentos en particular. Los Instrumentos STILLE Diamond revestidos pueden ser sensibles a la diatermia. Evite el contacto directo con el electrodo de diatermia ya que esto puede causar daños en el revestimiento de la superficie.
2. Limpie el instrumento, a mano o a máquina, tan pronto como sea posible tras su utilización. No deje secar partículas extrañas en el instrumento. No se recomienda ningún método de limpieza que contenga hidrógeno de peróxido para instrumentos de cromadura negra (ej: Tijeras SuperCut).
3. No conserve el instrumento en un ambiente húmedo más tiempo del necesario, por ej. mientras espera su transporte a la central de esterilización. Utilice únicamente los métodos adecuados para cada caso.
4. No deje los instrumentos en tensión, por ej. cerrados o enredados con otros instrumentos. En estos casos aumenta el riesgo de corrosión. Los instrumentos con cierre deben dejarse abiertos. Coloque los instrumentos más pesados debajo y los más ligeros encima. No coloque nunca los instrumentos microquirúrgicos unos encima de otros.
5. El agua y vapor de agua para la limpieza, desinfección y esterilización con autoclave pueden contener sales, metales y minerales que pueden provocar corrosión y manchas. Controle la calidad del agua. El agua dura debe ablandarse. Se recomienda el enjuague final del instrumento con agua desmineralizada.
6. Siga siempre las instrucciones del fabricante al usar productos desinfectantes y de limpieza. Utilice un detergente con un pH comprendido entre 8-10.5 a una dosis correcta según las instrucciones del fabricante. No almacene el instrumento en la solución por un tiempo mayor al indicado por el fabricante. Remoje, preferiblemente con agua desmineralizada. Seque el instrumento inmediatamente. Siga la norma EN-ISO 15883 y las directrices nacionales - sólo utilizar los procesos válidos de limpieza y desinfección.
7. Al limpiar a mano, utilice únicamente soluciones desinfectantes adecuadas. Siga las instrucciones del fabricante en lo que respecta a dosificación y tiempo. No tenga el instrumento en la solución más tiempo del indicado por el fabricante. Enjuáguelo, preferentemente con agua desmineralizada. Seque el instrumento inmediatamente.
8. En caso de utilizar ultrasonido para la limpieza del instrumento, éste debe estar abierto y completamente cubierto con la solución de limpieza. Instrumentos con revestimiento no deben ser limpiados con ultrasonido (ej: instrumentos con niquelado). Enjuáguelo, preferentemente con agua desmineralizada. Séquelo cuidadosamente. Siga las instrucciones del fabricante.
9. Controle el instrumento para evitar la aparición de suciedad, rayas, manchas, estrías y corrosión.
10. Controle la función de cada instrumento por separado.
11. Utilice únicamente cepillos para instrumentos. No utilice nunca estropajos de acero.
12. Después de cada uso, ponga aceite en el instrumento en los lugares en los que el metal esté en contacto con metal. El mejor momento para poner aceite es justo antes de la esterilización. Utilice preferentemente el aceite para instrumentos de STILLE. El aceite debe tener un punto de inflamación por encima de 1350C. Utilice el aceite con moderación en superficies que entran en contacto durante el uso (hojas, cierres y tornillos). Quite el aceite sobrante para evitar tener instrumentos grasientos y la aparición de manchas de grasa en el envase de esterilización con autoclave.
13. Siga las instrucciones del fabricante en la esterilización con autoclave. No coloque demasiados instrumentos a la vez. Durante la esterilización con autoclave, los instrumentos deben estar "abiertos" para que el vapor llegue a todos los rincones de cada instrumento.
14. No se recomienda la esterilización con aire caliente. Las elevadas temperaturas repercuten en el metal.
15. No se recomienda la esterilización con peróxido de hidrógeno para instrumentos de cromo negro. El color de estos instrumentos puede cambiar, aunque su funcionalidad no se vea afectada.
16. Antes de su primera utilización, limpie, controle, ponga aceite y esterilice todos los instrumentos nuevos.
17. Utilice únicamente un especialista/taller profesional para servicio y reparaciones. Por ej. las tijeras de Super Cut deben afilarse de modo especial, en caso contrario es fácil destruir la parte cortante. Si una reparación/servicio se realiza de modo incorrecto, la garantía de STILLE no es válida.

Garantie

El instrumental quirúrgico de nuestra propia fabricación tiene una garantía de 30 (Treinta) años contra cualquier defecto de manufacturación o calidad del material empleado, obligándonos a reemplazarlo o repararlo sin cargo alguno, siempre que sea debido a defectos del material o de su fabricación. El desgaste normal por su uso, queda excluido de dicha garantía. Esta garantía queda condicionada a que el instrumental sea utilizado para la finalidad prevista siendo cuidado y conservado de acuerdo con nuestras instrucciones y debiendo comunicar su deterioro por escrito dentro de los 30 días a partir del mismo.







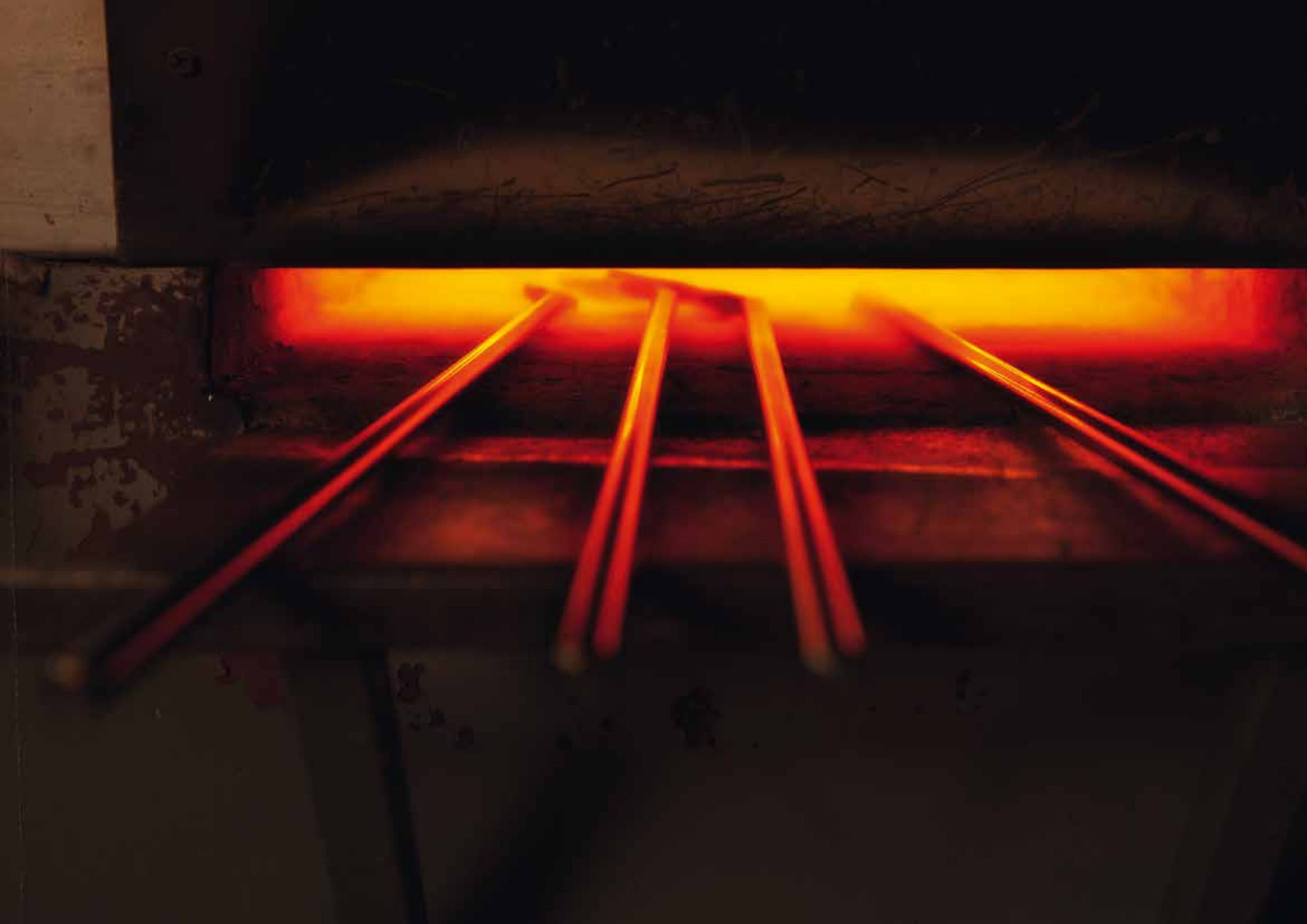

DR. LARS LEKSELL, professor i neurokirurgi vid Lunds universitet och Karolinska institutet, kirurg vid Serafimerlasarettet och Sundsvalls lasarett samt ledamot av Kungliga Vetenskapsakademien. Uppfann strålkniven Leksell Gamma Knife 1951. Utvecklade tillsammans med STILLE den mycket populära gougetången som bär namnet STILLE-Leksell.

DR. LARS LEKSELL, professor of neurosurgery at Lund University and the Karolinska Institute, surgeon at the Serafimer Hospital and Sundsvall Hospital and a member of the Royal Swedish Academy of Sciences. Inventor of the Leksell Gamma Knife in 1951. Developed in collaboration with STILLE the very popular gouge forceps bearing the name STILLE-Leksell.



STILLE Surgical Instruments

Edition 3.1, June 2018

Photos: Åke Gunnarsson, Vue and Jonas Frid, Studio Roland

Printing: Arkitektkopia AB

Paper on cover: Invercote Creato Matt 300 g. Paper, inlet: Galerie Art Gloss 130 g

Printed in Sweden 2018. Article number: 950-01-04

© STILLE AB 2018



“Det var ett intensivt arbetsamt liv, som Albert Stille kunde blicka tillbaka på när han 1880 lämnade över den tekniska ledningen av sin firma till sonen Max. Från morgon till kväll var han på verkstaden och på kontoret, knappast unnande sig någon ro ens under måltiderna. Arbetet följdes av stor framgång tack vare hans gedigna kunskaper, hans utomordentliga skicklighet i yrket och hans konstnärssinne. När det gällde att finna på nya metoder och nya instrument svek aldrig hans intresse, och han lät sig ej avskräckas av någon svårighet.”

Ur “STILLE 1841-1941 – Återblick på en hundraårig verksamhet”

“It was a hectic working life that Albert Stille looked back on in 1880 when he handed over the technical management of the company to his son Max. From morning to night he was at the shop and in the office, scarcely allowing himself to rest even at mealtime. The work was followed by great success due to his extensive knowledge, his outstanding skill in the profession and his inventive mind. When it came to finding new methods and new instruments his interest remained strong, and he allowed himself not to be discouraged by any difficulty that arose.”

From “STILLE 1841-1941 - Flashback on a century of operation”

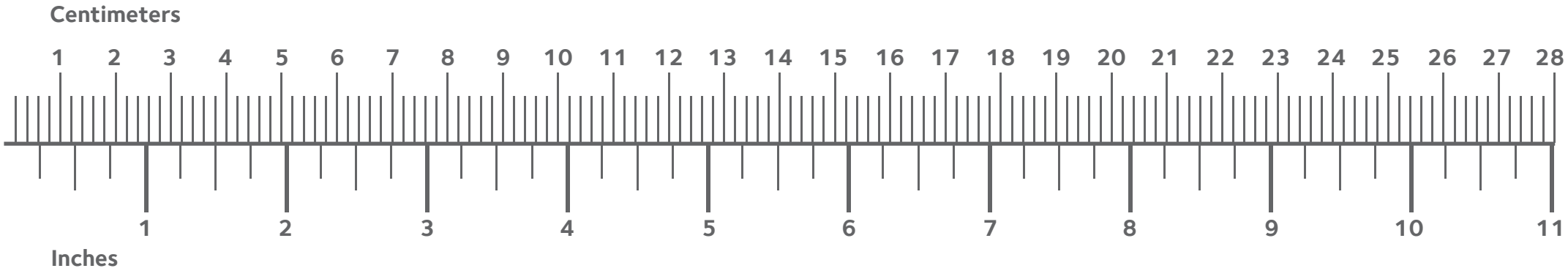



HANTVERK HELA VÄGEN. Att skapa kvalitetsinstrument är ett hantverk hela vägen – från instrumentmakaren till kirurgen. Passionen, yrkesskickligheten och fingertoppskänslan har de gemensamt. Och genom deras nära samarbete vidareutvecklas instrumenten. Sortimentet är specialiserat på tre områden – plastikkirurgi, ortopedi samt klassiska STILLE-instrument för flera olika kirurgiska discipliner. Gediget hantverk, suverän funktion och överlägsen kvalitet är de unika instrumentegenskaper som gör att STILLE efterfrågas av kirurger över hela världen.

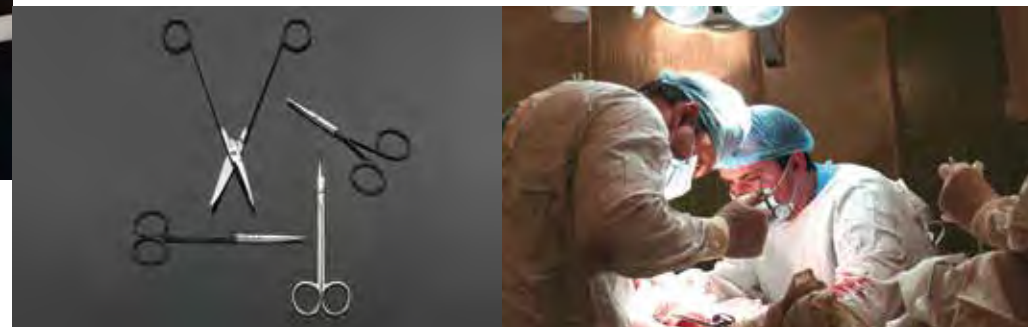

CRAFTSMANSHIP ALL THE WAY. Creating quality instruments is an art form every step of the way – from the instrument maker to the surgeon. Passion, professionalism and flair are common attributes. And through their close collaboration these precision instruments are fine-tuned and developed further. The product range is specialized in three areas – plastic surgery, orthopedics and classic STILLE instruments for various other surgical disciplines. True craftsmanship, outstanding performance and superior quality are the unique characteristics that make STILLE the hands down choice of surgeons worldwide.



Surgical Perfection

STILLE AB

Ekbacken 11
SE-644 30 Torshälla, Sweden
Phone: +46 8 588 580 00
Fax: +46 8 588 580 05
info@stille.se

www.stille.se

Stille Surgical Inc.

915 Parkview Blvd
Lombard, IL 60148
United States
Phone: 1.800.6651614

Distributed by: